



THE UNIVERSITY *of* EDINBURGH

This thesis has been submitted in fulfilment of the requirements for a postgraduate degree (e.g. PhD, MPhil, DClinPsychol) at the University of Edinburgh. Please note the following terms and conditions of use:

This work is protected by copyright and other intellectual property rights, which are retained by the thesis author, unless otherwise stated.

A copy can be downloaded for personal non-commercial research or study, without prior permission or charge.

This thesis cannot be reproduced or quoted extensively from without first obtaining permission in writing from the author.

The content must not be changed in any way or sold commercially in any format or medium without the formal permission of the author.

When referring to this work, full bibliographic details including the author, title, awarding institution and date of the thesis must be given.

The Attachment of the Floating Charge in Scots Law

Alisdair DJ MacPherson

Presented for the degree of Doctor of Philosophy

University of Edinburgh

2017

Abstract

This thesis examines the attachment of the floating charge to property in Scots law. The work is divided into two main parts. The first part focuses on how the charge interacts with property in a general sense. The second part considers attachment and its consequences in relation to the regimes for particular types of property.

It is contended that the floating charge does not directly affect property prior to attachment. And even upon attachment its status as a “real right” is questionable. This is primarily because the charge is patrimonially limited by its enforcement mechanisms. It can only be enforced through a liquidator, receiver or administrator, and the powers of these parties are seemingly confined to property in the chargor’s estate.

The thesis also demonstrates that ownership is a useful tool for examining what is required for a charge to attach to property. The most suitable approach is for ownership by the chargor to be both necessary *and* sufficient for attachment, but this is not the case under the present law, at least for certain property and transactions.

Other currently prevailing views regarding the charge’s attachment are also challenged. This includes the belief that the charge attaches as if it is the relevant form of security for the property in question. Instead, it is suggested that the charge should be considered to attach as a “*sui generis*” fixed security.

In addition, there are a range of difficulties that arise when the charge’s attachment and ranking are considered alongside the rules of transfer and security for specific property types. Uncertainty in the background law, and failure to take account of this when the charge was introduced, and subsequently, has meant that the charge may not operate effectively when, for example, property has been transferred for security purposes. All of this is explored in detail in the second part of the thesis.

Lay Summary

If a creditor is lending to a debtor, it will often seek to obtain a security interest in the debtor's property to protect itself against the risk of the debtor's non-repayment. In Scots law, debtor companies are able to grant a special form of security right called a floating charge. This is a security that can be granted over all types of property, from land to patents and from vehicles to claims for payment against customers. Unlike some other security rights, the floating charge does not require the creditor to possess the secured property. The charge enables a chargor to freely trade with charged property and the charge no longer covers property disposed of by the chargor, but does encompass newly acquired property. The chargor's freedom to trade with the property lasts until attachment takes place.

Attachment occurs within the context of certain insolvency-related processes: liquidation, receivership and administration. It gives the chargeholder an interest in each piece of charged property belonging to the chargor. The attached property can be sold by the appointed insolvency practitioner and the proceeds used to pay the debt due to the chargeholder.

In examining the attachment of the floating charge, this thesis principally considers the charge from a property law perspective. Throughout, there is an emphasis on interpreting the floating charge in a way that is coherent with wider Scots property law.

The first part of the thesis contains analysis of some general issues involving the floating charge's attachment: the nature of the charge prior to attachment, the events that cause attachment to take place, the property that is attached by a charge, and the effect of attachment. The final chapter in the first part focuses on the limitations placed upon the charge's operation by the insolvency-related processes in which the charge is enforced.

As well as the floating charge affecting attached property in a uniform way, it must also interact with legal regimes for specific types of property. The second part of the thesis considers these interactions. This includes analysis of when the charge can attach property like land, goods, and claims, when ownership of such property is being transferred by or to the chargor. It also identifies certain difficulties in the relationships between an attached charge and competing security interests.

Declaration

I, Alisdair David James MacPherson, do hereby declare that I have composed this thesis, that the work contained in it is my own, and that it has not been submitted for any other degree or professional qualification.

Alisdair DJ MacPherson
Edinburgh
August 2017

Acknowledgements

It would be possible to acknowledge a great many people for their assistance over the last four years. However, only a handful can be mentioned here.

First of all, I am grateful to my supervisors. Scott Wortley has been a source of guidance, support and encouragement from the very beginning of my PhD research. His role has been a vital one in enabling me to complete this thesis. My second supervisor, Professor George Gretton, has helped to improve my work immeasurably. I have learnt much from him and I was delighted that he agreed to continue as my supervisor despite his recent retirement. I am honoured to be his final student.

I would also like to express gratitude to my examiners, Dr Andrew Steven and Donna McKenzie Skene. They made my viva a pleasant experience and their comments on the thesis have been useful.

I thank Professor Reinhard Zimmermann for his generosity in giving me the opportunity to spend a year at the Max Planck Institute for Comparative and International Private Law in Hamburg. The experience was both enjoyable and enlightening. And I am grateful to Professor Kenneth Reid for arranging my research stay at the Institute.

This thesis could not have been undertaken without the financial support of the Edinburgh Legal Education Trust. I greatly appreciate ELET's sponsorship of my work and the financial assistance provided by the Max Planck Society and the Clark Foundation for Legal Education.

Finally, I wish to thank Claire Michie for her unfailing patience and optimism. This thesis is dedicated to her.

Contents

Abstract	3
Lay Summary	5
Declaration	7
Acknowledgments	9
Contents	11
Abbreviations	13
Chapter 1: Introduction	21
<i>PART 1: GENERAL PART</i>	
Chapter 2: The Floating Charge before Attachment	27
Chapter 3: Attachment Events	45
Chapter 4: The Property Attached	75
Chapter 5: The Attachment Hypothesis	105
Chapter 6: Enforcement of the Floating Charge	119
<i>PART 2: SPECIAL PART</i>	
Chapter 7: The Floating Charge and Heritable Property	161
Chapter 8: The Floating Charge and Corporeal Moveable Property	207
Chapter 9: The Floating Charge and Incorporeal Property	233
Chapter 10: Conclusion	267
Bibliography	271

Abbreviations

1893 Act	Sale of Goods Act 1893
1929 Act	Agricultural Credits (Scotland) Act 1929
1948 Act	Companies Act 1948
1961 Act	Companies (Floating Charges) (Scotland) Act 1961
1970 Act	Conveyancing and Feudal Reform (Scotland) Act 1970
1972 Act	Companies (Floating Charges and Receivers) (Scotland) Act 1972
1979 Act	Sale of Goods Act 1979
1985 Act	Companies Act 1985
1986 Act	Insolvency Act 1986
1986 Rules	Insolvency (Scotland) Rules 1986/1915
2002 Act	Enterprise Act 2002
2006 Act	Companies Act 2006
2007 Act	Bankruptcy and Diligence etc (Scotland) Act 2007
2012 Act	Land Registration etc (Scotland) Act 2012

2015 Act	Small Business, Enterprise and Employment Act 2015
2016 Act	Bankruptcy (Scotland) Act 2016
Anderson, <i>Assignment</i>	RG Anderson, <i>Assignment</i> (2008)
Anderson, <i>Possession</i>	C Anderson, <i>Possession of Corporeal Moveables</i> (2015)
Bankton	A McDouall, Lord Bankton, <i>An Institute of the Law of Scotland in Civil Rights</i> (1751-53) [reprinted 1993-95]
Bell, <i>Commentaries</i>	GJ Bell, <i>Commentaries on the Laws of Scotland and on the Principles of Mercantile Jurisprudence</i> , 5 th edn (1826) 2 vols
Bell, <i>Principles</i>	GJ Bell, <i>Principles of the Law of Scotland</i> , 4 th edn (1839) [reprinted 2010]
<i>Bell's Dictionary</i>	G Watson, <i>Bell's Dictionary and Digest of the Law of Scotland</i> , 7 th edn (1890) [reprinted 2012]
Bennett, "Companies"	DA Bennett, "Companies" in <i>The Laws of Scotland: Stair Memorial Encyclopaedia</i> , Reissue (2013)
BGB	<i>Bürgerliches Gesetzbuch</i>
<i>Burnett's Tr</i>	<i>Burnett's Tr v Grainger</i> [2004] UKHL 8; 2004 SC (HL) 19

Carey Miller, <i>Corporeal Moveables</i>	D Carey Miller (with D Irvine), <i>Corporeal Moveables in Scots Law</i> , 2 nd edn (2005)
<i>Cork Report</i>	<i>Report of the Review Committee on Insolvency Law and Practice</i> (Cmnd 8558) (1982)
<i>Eighth Report</i>	Law Reform Committee for Scotland, <i>Eighth Report of the Law Reform Committee for Scotland: The Constitution of Security over Moveable Property; and Floating Charges</i> (Cmnd 1017) (1960)
Erskine, <i>Institute</i>	J Erskine of Carnock, <i>An Institute of the Law of Scotland</i> , 1 st edn (1773) [reprinted 2014]
<i>Forth & Clyde</i>	<i>Forth & Clyde Construction Co Ltd v Trinity Timber & Plywood Co Ltd</i> 1984 SC 1
Gloag, <i>Contract</i>	WM Gloag, <i>The Law of Contract: A Treatise on the Principles of Contract in the Law of Scotland</i> , 2 nd edn (1929)
Gloag and Irvine, <i>Security</i>	WM Gloag and JM Irvine, <i>Law of Rights in Security: Heritable and Moveable Including Cautionary Obligations</i> (1897)
Goode, <i>Commercial Law</i>	E McKendrick, <i>Goode on Commercial Law</i> , 5 th edn (2016)
Goode, <i>Legal Problems</i>	L Gullifer (ed), <i>Goode on Legal Problems of Credit and Security</i> , 5 th edn (2013)
Goode, <i>Principles of Corporate Insolvency</i>	RM Goode, <i>Principles of Corporate Insolvency Law</i> , 4 th edn (2011)

Goudy, <i>Bankruptcy</i>	H Goudy, <i>A Treatise on the Law of Bankruptcy in Scotland</i> , 2 nd edn (1895)
Gow, <i>Mercantile Law</i>	JJ Gow, <i>The Mercantile and Industrial Law of Scotland</i> (1964)
<i>Greene and Fletcher: Receivership</i>	IM Fletcher and R Roxburgh, <i>Greene and Fletcher, The Law and Practice of Receivership in Scotland</i> , 3 rd edn (2005)
Gretton, “Concept of Security”	GL Gretton, “The Concept of Security” in DJ Cusine (ed), <i>A Scots Conveyancing Miscellany: Essays in Honour of Professor JM Halliday</i> (1987)
Gretton, <i>Inhibition</i>	GL Gretton, <i>The Law of Inhibition and Adjudication</i> , 2 nd edn (1996)
Gretton, “Radical Rights”	GL Gretton, “Radical Rights and Radical Wrongs: A Study in the Law of Trusts, Securities and Insolvency” 1986 JR 51 and 192
Gretton and Steven, <i>PTS</i>	GL Gretton and AJM Steven, <i>Property, Trusts and Succession</i> , 2 nd edn (2013)
<i>Halliday’s Conveyancing</i> , vol 1	IJS Talman (ed), <i>Halliday’s Conveyancing Law and Practice in Scotland</i> , 2 nd edn (1996), vol 1
<i>Halliday’s Conveyancing</i> , vol 2	IJS Talman (ed), <i>Halliday’s Conveyancing Law and Practice in Scotland</i> , 2 nd edn (1997), vol 2
<i>Heritable Reversionary</i>	<i>Heritable Reversionary Co v Millar</i> (1892) 19 R (HL) 43

InsO	<i>Insolvenzordnung</i>
<i>Iona Hotels</i>	<i>Iona Hotels Ltd (In Receivership) v Craig</i> 1990 SC 330
<i>Libertas-Kommerz</i>	<i>Libertas-Kommerz GmbH v Johnson</i> 1977 SC 191
<i>Lord Advocate v RBS</i>	<i>Lord Advocate v Royal Bank of Scotland</i> 1977 SC 155
Mackenzie, <i>Institutions</i>	Sir G Mackenzie of Rosehaugh, <i>The Institutions of the Law of Scotland</i> , 2 nd edn (1688)
<i>MacMillan</i>	<i>MacMillan v T Leith Developments Ltd</i> [2017] CSIH 23; 2017 SLT 415
McAllister, <i>Leases</i>	A McAllister, <i>Scottish Law of Leases</i> , 4 th edn (2013)
McBryde, <i>Contract</i>	WW McBryde, <i>The Law of Contract in Scotland</i> , 3 rd edn (2007)
McKenzie Skene, “Corporate Insolvency”	DW McKenzie Skene, “Corporate Insolvency” in <i>The Laws of Scotland: Stair Memorial Encyclopedia</i> , Reissue (2008)
McKenzie Skene, <i>Insolvency</i>	DW McKenzie Skene, <i>Insolvency Law in Scotland</i> (1999)
Mokal, <i>Corporate Insolvency</i>	RJ Mokal, <i>Corporate Insolvency Law: Theory and Application</i> (2005)
NRS	National Records of Scotland

<i>National Reports</i>	W Faber and B Lurger (eds), <i>National Reports on the Transfer of Movables in Europe</i> (2008-2011) 6 vols
Paisley, <i>Land Law</i>	RRM Paisley, <i>Land Law</i> (2000)
<i>Palmer's Company Insolvency</i>	DA Bennett, <i>Palmer's Company Insolvency in Scotland</i> (1993)
<i>Re Panama</i>	<i>Re Panama, New Zealand and Australian Royal Mail Co</i> (1869-70) LR 5 Ch App 318
Reid, <i>Property</i>	KGC Reid (with GL Gretton, AGM Duncan, WM Gordon and AJ Gamble), <i>The Law of Property in Scotland</i> (1996)
Reid and Zimmermann, <i>History</i>	KGC Reid and R Zimmermann (eds), <i>A History of Private Law in Scotland</i> (2000) 2 vols
<i>Secured Transactions Law Reform</i>	L Gullifer and O Akseli (eds), <i>Secured Transactions Law Reform: Principles, Policies and Practice</i> (2016)
Session Papers	<i>General Collection of Session Papers</i> (Advocates Library)
<i>Sharp</i>	<i>Sharp v Thomson</i> 1997 SC (HL) 66
Sim, "Rights in Security"	AJ Sim, "Rights in Security over Moveables" in <i>The Laws of Scotland: Stair Memorial Encyclopaedia</i> , vol 20 (1992)

SLC, 1961 Act Memorandum	Scottish Law Commission, <i>Memorandum No 10 – Examination of the Companies (Floating Charges) (Scotland) Act 1961</i> (1969)
SLC, 1961 Act Report	Scottish Law Commission, <i>Report on the Companies (Floating Charges) (Scotland) Act 1961</i> (No 14) (Cmnd 4336) (1970)
SLC, Moveable Transactions	Scottish Law Commission, <i>Discussion Paper on Moveable Transactions</i> (DP 151) (2011)
SLC, Registration Report	Scottish Law Commission, <i>Report on Registration of Rights in Security by Companies</i> (No 197) (2004)
SME	<i>The Laws of Scotland: Stair Memorial Encyclopedia</i>
SLC, Sharp Report	Scottish Law Commission, <i>Report on Sharp v Thomson</i> (No 208) (2007)
Smith, Short Commentary	TB Smith, <i>A Short Commentary on the Law of Scotland</i> (1962)
St Clair and Drummond Young, Corporate Insolvency	J St Clair and J Drummond Young, <i>The Law of Corporate Insolvency in Scotland</i> , 4 th edn (2011)
Stair	J Dalrymple, Viscount Stair, <i>The Institutions of the Law of Scotland</i> (DM Walker (ed) (1981))
Steven, Pledge	AJM Steven, <i>Pledge and Lien</i> (2008)
Styles, “Two Types of Floating Charge”	SC Styles, “The Two Types of Floating Charge: The English and the Scots” 1999 SLPQ 233

<i>Telford</i>	<i>National Commercial Bank of Scotland v Liquidators of Telford Grier Mackay & Co</i> 1969 SC 181
Wilson, <i>Debt</i>	WA Wilson, <i>The Scottish Law of Debt</i> , 2 nd edn (1991)
Wortley, “Squaring the Circle”	S Wortley, “Squaring the Circle: Revisiting the Receiver and ‘Effectually Executed Diligence’” 2000 JR 325

CHAPTER 1

INTRODUCTION

A. BACKGROUND

At common law, floating charges were rejected in Scotland.¹ Due to their non-compliance with the required formalities for creating security rights, Lord President Cooper famously described them as “utterly repugnant to the principles of Scots law”.² However, the existing system, requiring delivery of corporeal moveables to the creditor and an equivalent for other property types, was considered too burdensome and restrictive for commerce, especially in comparison to the position in England.³ This led to the introduction, in 1961,⁴ of the statutory floating charge, a non-possessory security adapted from the floating charge of English equity. The Scottish floating charge is available over all types of property, as that property changes from time to time, but can only be granted by incorporated companies and certain other corporate entities.⁵ The introduction of the floating charge has been described as “the most important innovation in commercial law in the [twentieth century]”.⁶ Yet, despite the charge’s apparent popularity with legal practitioners and some of their clients,⁷ it has been heavily criticised by academics.⁸

¹ *Ballachulish Slate Quarries Co v Bruce* (1908) 16 SLT 48; *Carse v Coppen* 1951 SC 233.

² *Carse* (n 1) per LP Cooper at 239.

³ See *Eighth Report*, paras 1f and 4ff.

⁴ By the 1961 Act. This originated as a Private Members’ Bill introduced under the Ten-Minute Rule by Forbes Hendry MP.

⁵ 1985 Act, s 462(1). The other entities are LLPs (see Limited Liability Partnerships (Scotland) Regulations 2001/128 (SSI), reg 3); European economic interest groupings (see European Economic Interest Grouping Regulations 1989/638, reg 18); industrial and provident societies (Co-operative and Community Benefit Societies Act 2014, s 62 (formerly the Industrial and Provident Societies Act 1967, s 3); and now also building societies (see Financial Services (Banking Reform) Act 2013 (Commencement (No 8) and Consequential Provisions) Order 2015/428, Art 4).

⁶ GL Gretton, “What Went Wrong with Floating Charges?” 1984 SLT (News) 172 at 172.

⁷ See eg SLC, *Moveable Transactions*, para 9.15. See also J Hardman, “Some Legal Determinants of External Finance in Scotland: A Response to Lord Hodge” (2017) 21 EdinLR 30 at 49f, who argues in favour of greater conformity between Scots law and English law for floating charges. *Eighth Report*, para 30, stated that in commercial law it is “desirable” for Scots law and English law to be the same, “unless there is good reason to the contrary”. See also HL Deb, 5 July 1961, vol 232, col 1436 (Viscount Colville of Culross).

⁸ See eg Gretton (n 6); GL Gretton, “Should Floating Charges and Receivership Be Abolished?” 1986 SLT (News) 325; GL Gretton, “Reception without Integration? Floating Charges and Mixed Systems” (2003) 78 TulaneLR 307; D Cabrelli, “The Case Against the Floating Charge in Scotland” (2005) 9 EdinLR 407. For judicial criticism, see eg *Lord Advocate v RBS* per Lord Cameron at 173; and, most recently, *MacMillan* per Lord Drummond Young at paras 121f. Cf eg RB Jack, “The

These criticisms have often focused on the floating charge's supposed incompatibility with wider Scots law, particularly property law. Undoubtedly, the story of the charge in Scotland has been a difficult one. And there are many reasons for the problems encountered. The charge represented a departure from long-standing principles regarding the creation and operation of security rights. It was introduced from English equity into a non-equitable system at a time when Scots law lacked the conceptual coherence and academic rigour of more recent decades. Provisions within the various iterations of the legislation are abstruse, use terms unfamiliar in Scots law, and lack clarity of thought, and this has sometimes been compounded by ill-advised judicial interpretation. Meanwhile, attempts to better integrate the floating charge into Scots law have often been unsuccessful.⁹ Another issue is that consideration of the floating charge is inherently complicated, as it stands at the intersection points of company law, commercial law, property law and insolvency law. Consequently, there are competing interests and legal principles at work.

The present thesis explores one particular aspect of the floating charge in Scots law: attachment.¹⁰ Like much of the floating charge, it has suffered from an absence of systematic analysis.¹¹ Attachment is the means by which the charge affects particular property. It thereby facilitates ranking against other competing rights, can lead to enforcement through sale of the property by an insolvency practitioner and, ultimately, is necessary for distribution to the chargeholder.¹² As a result, it is central to the floating charge's nature in Scots law. Throughout this thesis, attention is paid to the floating charge attaching to the property of limited companies in liquidation, administration and receivership. The possibility of a chargeholder appointing a receiver has been significantly curtailed; however, it was formerly the most common means of enforcing a charge and many cases have involved interpreting the charge through the prism of receivership.

Coming of the Floating Charge to Scotland: an Account and an Assessment" in DJ Cusine (ed), *A Scots Conveyancing Miscellany: Essays in Honour of Professor JM Halliday* (1987); and Lord Rodger of Earlsferry, "Say Not the Struggle Naught Availeth": The Costs and Benefits of Mixed Legal Systems" (2003) 78 *TulaneLR* 419 at 423ff.

⁹ Eg part 2 of the 2007 Act has not been introduced – see AJM Steven and H Patrick, "Reforming the Law of Secured Transactions in Scotland" in *Secured Transactions Law Reform*, 262f.

¹⁰ This is often referred to in practice using the English term "crystallisation".

¹¹ There have been some exceptions, eg R Rennie, "Floating Charges: A Treatise from the Standpoint of Scots Law" (PhD Thesis, University of Glasgow) (1972).

¹² The concept needs to be distinguished from "attachment" in other systems, such as the American UCC Art 9 or English law – see eg Goode, *Commercial Law*, para 22.78 and ch 23 (cf Goode, *Legal Problems*, para 4-07). Insofar as it creates an interest in property that is effective against third parties, attachment in Scots law shares more in common with the concept of "perfection" in those systems.

It is important to note that for a floating charge to be effective against creditors, an administrator or a liquidator, specified documentation must be delivered to the registrar of companies within 21 days after the date of the floating charge's creation, to enable registration.¹³ The date of creation was formerly the charge's execution date, but now appears to be the date of its delivery to the chargee.¹⁴ Where floating charges are mentioned in this thesis, it is assumed that these registration-related requirements have been complied with, unless otherwise stated.

B. METHODOLOGY

This thesis is, principally, a doctrinal work. Legal sources have been examined to determine the current law. The most important sources for the floating charge are, of course, the legislation, and the case law that interprets that legislation. At various points, the currently prevailing views of aspects of the floating charge's attachment, and wider operation, are criticised and contrary interpretations are proposed. Some suggestions for reform are also provided. The focus on attachment means that the primary area of research is property law. The thesis presents an account of the floating charge that coheres with wider property law and insolvency law in Scotland. An inter-connected approach to the charge's attachment, ranking and enforcement is also evident.

Legal historical research has been undertaken to help understand the background to the current law. As well as consideration of superseded legislation, this has involved archival research relating to the introduction of the floating charge. In addition, papers published by the Law Reform Committee for Scotland (LRCS) and the Scottish Law Commission (SLC), and Hansard documentation, have been consulted as aids to understanding the historical and modern law. From a doctrinal perspective, superseded legislation and related materials are used for interpretive purposes. This is justified given that the current legislation contains some identical and similar provisions and these represent a continuation of the previous law.¹⁵

¹³ 2006 Act, ss 859A ff.

¹⁴ See 2006 Act, s 859E, for the current position. For the former position, see the now-repealed s 879(5)(a). See also *AIB Finance Ltd v Bank of Scotland* 1993 SC 588.

¹⁵ See eg *MacMillan* per LP Carloway at paras 58ff and Lord Drummond Young at 98ff; Wortley, "Squaring the Circle", 337ff. For relevant statutory interpretation authorities, see eg *AG v Prince Ernest Augustus of Hanover* [1957] AC 436; *United States Government v Jennings* [1983] 1 AC 624

The doctrinal work is also supplemented by some comparative analysis. Given the floating charge's adaptation from English law, and the fact that certain elements of company law and corporate insolvency are common across the jurisdictions, there are a number of references to the legal position in England, past and present. However, although the English and Scottish floating charges are, arguably, of the same genus, they are separate species operating in different environments. Consequently, English law is of limited value when considering certain aspects of the Scottish floating charge, especially as regards its interaction with property law.¹⁶ Other legal systems, particularly Germany, are referred to at points to help explain features of Scots insolvency and property law or to act as comparators. The thesis does not consider international private law or cross-border issues involving the floating charge.¹⁷

C. STRUCTURE

This work is divided into two main parts. The first is the general part and comprises chapters 2 to 6. The floating charge is a universal security and the general focus of the first part reflects the fact that, in particular respects, the charge's operation is not dependent upon the type of property charged. This is certainly true as regards the charge prior to attachment, as property subject to the charge is interchangeable and freely circulates, and this is dealt with in chapter 2. The following chapters examine, in turn: the events that cause attachment to take place, the property attached by the charge and the general effect of attachment. These issues, to a lesser or greater degree, are not dependent upon the specific types of property affected. And no matter what property is attached, the enforcement mechanisms of administration, liquidation and receivership are the same, and are analysed in chapter 6.

The second part is the special part, formed by chapters 7 to 9. This material is necessary as a floating charge also interacts with specific regimes based upon the type of property attached. Chapter 7 examines attachment within the context of the transfer of corporeal heritable property, as well as competition between floating charges and heritable securities, past and present. The next chapter analyses attachment and corporeal moveable property. And the final

per Lord Roskill at 641ff; *Pepper v Hart* [1993] AC 593; O Jones, *Bennion on Statutory Interpretation: A Code*, 6th edn (2013), 547ff.

¹⁶ See eg Styles, "Two Types of Floating Charge"; and *Telford* per Lord Cameron at 202f.

¹⁷ These are particularly difficult matters.

substantive chapter deals with the problematic relationship between the floating charge and incorporeal property.

CHAPTER 2

THE FLOATING CHARGE BEFORE ATTACHMENT

A.	INTRODUCTION	27
B.	NATURE OF THE FLOATING CHARGE BEFORE ATTACHMENT	28
	(1) A Real Right?	28
	(2) Personal Rights and Powers	33
	(3) Analogies	40
	(4) Negative Pledge	41
C.	CONCLUSION	44

A. INTRODUCTION

There are two principal stages to consider when examining the nature of the floating charge in Scots law: (i) between creation and attachment; and (ii) upon attachment. The former will be the focus of this chapter. The nature of the Scottish floating charge at stage (i) has received minimal attention from commentators.¹⁸ By contrast, the English position has been much discussed and there are various competing theories as to the nature of the floating charge in English law before crystallisation.¹⁹ (There is widespread support, however, in favour of the floating charge creating an immediate proprietary interest.)²⁰ These interpretations are of limited value in the Scottish context as they are dependent upon the background system(s) of English law and equity. There is no system of equity in Scotland and the Scottish floating charge is a statutory creation, unlike its English counterpart. It is therefore necessary to analyse the nature of the Scots law floating charge by interpreting the relevant legislation and framing

¹⁸ However, see Styles, “Two Types of Floating Charge”.

¹⁹ Cf WJ Gough, *Company Charges*, 2nd edn (1996), 97ff and 132ff; S Worthington, *Proprietary Interests in Commercial Transactions* (1996), 79ff; R Nolan, “Property in a Fund” (2004) 120 LQR 108; Goode, *Legal Problems*, para 4-03; Goode, *Commercial Law*, para 25.04ff. See H Beale et al, *The Law of Security and Title-Based Financing* (2012), paras 6.74ff, and D Sheehan, *The Principles of Personal Property Law*, 2nd edn (2017), 355ff, for summaries of the various theories.

²⁰ See Nolan (n 19); P Giddins, “Floating Mortgages by Individuals: Are they Conceptually Possible?” (2011) 3 JIBFL 125 at 125; Goode, *Legal Problems*, para 4-03; Goode, *Commercial Law*, para 25.07; Sheehan, *Personal Property Law* (n 19), 355ff. Yet there are differences between the particular theories outlined by these writers.

it against the background of Scotland’s principally Civilian system of property.²¹ The charge’s statutory existence means that it does not need to conform to the existing dichotomy of personal and real rights in Scots property law, either before or upon attachment. Nevertheless, it is sensible, for coherence purposes, to attempt to fit the charge within this model.

B. NATURE OF THE FLOATING CHARGE BEFORE ATTACHMENT

(1) A Real Right?

(a) History

The LRCS’s description²² of the proposed floating charge included a reference to its status before attachment: “A security over the whole or a specified part of a company’s undertaking and assets which shall not preclude the company from selling or otherwise dealing with such assets in the ordinary course of business until the company goes into liquidation...”²³ The reference to “security” here provides few details beyond the floating charge’s general purpose. Allowing for the dealing of assets “in the ordinary course of business” was in line with the English position,²⁴ and might have facilitated an analysis of the charge as an immediate real right, but with the chargor having general authority to transfer ownership and create other real rights. The *Eighth Report* did not, however, offer a remedial mechanism if there was dealing before liquidation outside the ordinary course of business. And an “ordinary course” dealing provision was notably left out of the legislation that followed.²⁵

The 1961 Act provided that an incorporated company could create a floating charge “over all or any of the property, heritable and moveable, which may from time to time be comprised in its property and undertaking”.²⁶ The Act further stated that a floating charge would “not affect

²¹ As Styles, “Two Types of Floating Charge” (n 18) at 239 asserts, the English floating charge is a different concept from the Scottish floating charge and therefore the English authorities should (largely) be “eschewed”. Cf R Rennie, “The Tragedy of the Floating Charge in Scots Law” 1998 SLPQ 169; and Rennie (n 11).

²² It is misleadingly referred to as a “definition” in the *Eighth Report*, Appendix II, para 1.

²³ Ibid.

²⁴ See eg *Re Yorkshire Woolcombers Association* [1904] AC 355 affirming [1903] 2 Ch 284, in which Romer LJ, at 295, provided the standard description of the floating charge.

²⁵ Despite having been included in early drafts of the Bill: see NRS AD63/481/3.

²⁶ 1961 Act, s 1(1).

any property which ceases prior to the commencement of the winding up of the company to be comprised in, and remains outwith, the company's property and undertaking...". But, upon the commencement of winding up, the charge would "attach to the property then comprised in the company's property and undertaking".²⁷ The most obvious interpretation of this combined wording is that a floating charge only affected the company's property at winding up, thus implying that before attachment the charge was not "real". Indeed, Forbes Hendry MP's statement, at the House of Commons Committee Stage of the 1961 Act, that the floating charge "does not come into effect until the beginning of the winding-up" can be read in the same way.²⁸ And, in *Telford*,²⁹ the First Division considered that the effect of a floating charge upon attachment,³⁰ under the 1961 Act, was akin to a real right being obtained,³¹ from which it might be inferred that the charge was not real prior to attachment.

Although the 1961 Act provisions can help determine the original intended nature of the charge, the 1972 Act altered the applicable wording. Instead of stating that the floating charge would not affect property which left the company's property and undertaking before winding up, the Act simply referred to attachment of property in the company's property and undertaking at winding up, and upon receivership.³² The 1972 Act also removed the express reference to heritable and moveable property,³³ thus reinforcing the notion that a floating charge treats property unitarily, at least until attachment intervenes and specific property systems apply.³⁴ In these respects, the currently applicable 1985 Act is in the same terms.

(b) Theories

The absence of a clear legislative statement regarding the charge's pre-attachment nature means it is necessary to extrapolate this from the current creation provision and through comparison with the charge's nature upon attachment. The 1985 Act, s 462(1), allows

²⁷ Ibid, s 1(2).

²⁸ Scottish Standing Committee, 20 June 1961, cols 15-16, and see the Lord Advocate's similar comment at col 19. See also HL Deb, 5 July 1961, vol 232, cols 1436-1437 (Viscount Colville of Culross).

²⁹ Especially per LP Clyde at 194f and Lord Guthrie at 198f.

³⁰ The statutory hypothesis is discussed in chapter 5.

³¹ However, the extent to which the chargeholder's interest upon attachment is a real right is debatable: see 117ff and 156ff.

³² 1972 Act, s 1(2); and ss 13 and 14 for receivership.

³³ Ibid, s 1(1).

³⁴ Indeed, there are advantages in property being treated in a uniform way, given the revolving nature of the charged property before attachment.

companies to create floating charges and describes a floating charge as “a charge... over all or any part of the property... which may from time to time be comprised in [the company’s] property and undertaking”.³⁵ (This provision applies irrespective of whether or how the floating charge attaches and is enforced). Unlike in English law, “charge” has no core, established meaning in Scots property law³⁶ but here it could be a real interest in each piece of property in a fluid and changeable fund³⁷ or simply the *potential* for a real interest in specific items of property.³⁸ The former (the immediate interest theory) might involve the existence of a right in each charged item in the company’s property and undertaking at any given point, but where the chargor’s exercise of its power to dispose of property extinguishes the chargeholder’s right.³⁹ By contrast, the latter approach (the potential interest theory) does not involve the creation of any right in property but only the possibility for such a right to arise.

(c) An Immediate Interest in Property?

The immediate interest theory has some support from the fact that the charge is created “over... the property”. This terminology is used in a number of other contexts where property *is* directly affected.⁴⁰ The 1970 Act (as amended) states that it is competent to grant and register a standard security “over any land or real right in land”.⁴¹ (Formerly, before amendment, this read as “over any interest in land”.) The term “over” can, however, also be viewed as a general expression referring to a security interest relating to property, but which requires further explanation as to its nature at a given time. Indeed, for the standard security, a separate provision states that it confers an immediate real right in security in specific property.⁴²

³⁵ 1985 Act, s 462(1). The 2007 Act, s 38(1) has similar wording (although, unlike s 462(1), contains no express reference to uncalled capital) but is unlikely now to ever be introduced.

³⁶ However, “charge” does appear in related contexts with different meanings – consider eg charges for payment, as regards diligence, and agricultural charges created under the 1929 Act.

³⁷ There is a resemblance here to some of the theories in English law (see above). For example, Nolan (n 19) at 126ff, suggests the chargee has an immediate right in the property in a fund but the chargor has an immunity regarding property alienated in the ordinary course of business.

³⁸ The potential impact might extend to the effect of negative pledges. See below.

³⁹ This is similar to the landlord’s hypothec, albeit that the acquisition of property free from the landlord’s hypothec is dependent upon the transferee being in good faith: 2007 Act, s 208(5).

⁴⁰ Including the attachment effect of a floating charge as if it is “a fixed security over the property”: see 1985 Act, s 463(2); 1986 Act, ss 53(7), 54(6) and Sch B1, para 115(4).

⁴¹ S 9(2).

⁴² See 1970 Act (as amended), s 11(1). And see the rest of that Act for details as to how the secured property is affected by the existence of the standard security.

Stating that the floating charge creates an immediate real right in property, upon creation, is arguably inappropriate (or meaningless), unless the chargeholder has rights exercisable against the property at that time. It is not infeasible that a floating charge confers an inherent right to prevent the debtor from destroying or damaging the charged property. Likewise, could a chargeholder stop the granting of a limited real right,⁴³ such as a lease, liferent or servitude, or render that grant ineffective, unless it had consented? This might be particularly useful to the chargeholder where the grant would diminish the value of the charged property.⁴⁴ The chargeholder having such preventive and prohibitory rights is, nevertheless, unlikely. There is no evidence to suggest that the floating charge in Scots law (apparently unlike in English law)⁴⁵ has any direct effect on property before attachment. The floating charge in Scotland is a statutory device and, therefore, one would expect pre-attachment enforcement mechanisms for property to be outlined in the legislation, but they are not.⁴⁶

(d) The Absence of a Real Right

The chargor's ability to use and freely trade with charged property until attachment is a fundamental aspect of the floating charge and also undermines the argument that it is real before attachment. Ownership can be transferred and subordinate real rights can be created, in spite of the charge's existence. If the pre-attachment floating charge is a real right, subsequently obtained real rights ought to be subject to it. But this is not so. Any effect the charge has regarding real rights must derive from the legislation. And given the absence of relevant provisions, it can be strongly presumed that the floating charge, in its unattached state, does not affect real rights acquired by third parties in charged property. Even when the charge attaches, it generally remains subject to real rights already in existence; it is the chargor's property at the time of the attachment that is affected and it may no longer own the property or its proprietary interest may already be encumbered by other real rights. (It will usually not be possible for real rights to be transferred or created by the chargor after attachment as it will no longer have power over the property.)⁴⁷

⁴³ Except for rights in security, which are expressly catered for through ranking in the floating charges legislation.

⁴⁴ For a potential model, see eg *Edinburgh Entertainments Ltd v Stevenson* 1926 SC 363 in which the disponent of an *ex facie* absolute disposition qualified by back letter was held to retain the power to grant leases, so long as the grant did not depreciate the bank's security.

⁴⁵ See eg Sheehan, *Personal Property Law* (n 19), 355f.

⁴⁶ See eg the description of the (then-applicable) floating charges legislation as a "code, complete in itself" (albeit in relation to receivers' powers) in *Forth & Clyde* per LP Emslie at 11 (and similar wording at 9).

⁴⁷ See 134ff.

It seems that express statutory provision is necessary to produce an exception to the general position that the floating charge does not affect real rights established before attachment. Such provision is only made for the relationship between the charge and other security rights. If the charge is a real right in security from its creation, it should rank ahead of other subsequently-created real security rights (*prior tempore potior jure*). The default legislative rule provides that a charge ranks *behind* a fixed security created at any time prior to the charge's attachment.⁴⁸ However, a statutory exception allows a charge to rank from its creation as against voluntary fixed securities (and floating charges) granted in breach of a negative pledge contained in the charge instrument.⁴⁹ As negative pledges are ubiquitous, a floating charge will, in reality, usually rank ahead of any voluntary fixed security (or further floating charge) created after the charge.⁵⁰ Yet, for the charge to directly compete with other security rights as regards property, or proceeds of property, attachment is necessary. For such competition to arise, the enforcement mechanisms connected with attachment are important, as is the fact that the charge attaches as if it were a fixed security. An *attached* charge is expressly subject to the rights of those with prior-ranking fixed securities (and floating charges). And, conversely, it prevails against lower-ranking fixed securities (and floating charges).⁵¹ If an *unattached* charge does not have real effect, one might expect an express provision specifying that a charge in that state is subject to all fixed securities. However, the absence of such provision is apt: the charge does not affect property *subject to* these securities, instead, it has *no effect* on property before attachment. The unattached charge is therefore entirely ineffective, in property terms, in relation to all other security rights. One provision which superficially gives credence to an alternative view is s 27(1) of the 1970 Act, which could be interpreted as requiring an enforcing standard security holder to distribute proceeds of sale to the holder of an unattached charge.⁵² Instead, it is more appropriate to read "securities" in the section as referring to security rights directly in the property sold, and the charge does not create any such interest until attachment.⁵³

⁴⁸ 1985 Act, s 464(4)(a). And see the implications of this at: 1985 Act, s 463(1)(b); 1986 Act, ss 55(3)(b), 60(1)(a); 1986 Act, Sch B1, para 116(a) and (e).

⁴⁹ 1985 Act, s 464(1)(a) and (1A).

⁵⁰ Without negative pledges, floating charges rank against each other according to their dates of registration in the charges register – 1985 Act, s 464(4)(b).

⁵¹ This is the implication of: 1985 Act, s 463 and the attachment mechanism; 1986 Act, s 60(2); 1986 Act, Sch B1, para 116(e) and (f).

⁵² In practice, a chargeholder may, by this point, have sought to enforce the charge.

⁵³ See 123ff for further discussion of this provision.

Ranking against diligence provides another test of the “realness” of a security right. In this regard, attachment again appears to be the key milestone for floating charges. Upon attachment a charge is subject to the rights of those with “effectually executed diligence”,⁵⁴ and impliedly prevails against diligence not falling within this category.⁵⁵ The absence of any statutory provision dealing with a floating charge and diligence before attachment again indicates that the charge will not affect any type of diligence (effectually executed or not) unless and until attachment occurs. Once more, this is because the unattached charge does not give an interest in any property.

The above material suggests that the potential interest theory is preferable. An unattached floating charge does not directly affect property or allow any real actions by the chargeholder. It is therefore not appropriate to describe it as a real right, which would be the result of adopting the immediate interest approach. By contrast, upon attachment there is a more clearly identifiable real connection between the floating charge and specific property; the floating charge attaches “to the property” and there are “real” consequences arising from this.⁵⁶ The relevant remedies for a chargeholder concerned about the actions of a chargor, before attachment, seem to only be indirectly related to property: to bring about attachment and/or the displacement of the chargor’s management, or to use personal contractual rights to enforce obligations binding the chargor. The precise nature of the charge between creation and attachment will be discussed in the next section.

(2) Personal Rights and Powers

If the floating charge is not a real right between its creation and attachment, then what is it? Scott Styles characterises the floating charge, at this stage, as a “conditional real right”,⁵⁷ which the SLC acknowledge is correct in a “broad sense”.⁵⁸ Likewise, Gow provides an anticipatory description by referring to the floating charge as a “voluntary dormant hypothec”.⁵⁹ These are designations of the floating charge before attachment with reference

⁵⁴ 1985 Act, s 463(1)(a); 1986 Act, ss 55(3)(a) and 60(1)(b). The position for diligence in administration is more complicated and the attached charge is not specifically made subject to any diligence.

⁵⁵ See *Lord Advocate v RBS*; and *MacMillan*.

⁵⁶ 1985 Act, s 463(1) and (2); 1986 Act, ss 53(7), 54(6); and Sch B1, para 115(1B), (3)-(4).

⁵⁷ Styles, “Two Types of Floating Charge” at 240.

⁵⁸ SLC, *Moveable Transactions*, para 9.14, n 33; para 22.5, n 10.

⁵⁹ Gow, *Mercantile Law*, 279. Here, Gow also describes the landlord’s hypothec as an “involuntary” or “legal” dormant hypothec.

to what it becomes when attachment occurs.⁶⁰ Styles notes, however, that a conditional real right is a personal right. He uses legislation and judicial decisions to argue that attachment causes a floating charge to become a real right.⁶¹ By implication, the charge cannot be such a right prior to attachment and, therefore, must be a personal right, according to the dichotomy of Scots law.⁶² Styles suggests that, in its pre-attachment form, the floating charge is “merely the personal right to appoint a receiver, if the company defaults on the loan, and nothing more.”⁶³ As shall now be discussed, this is an insufficient explanation of what a floating charge confers before attachment, but Styles is correct to identify the absence of a real interest.

(a) A Conditional Real Right?

If A Ltd contracts to create a floating charge in favour of B Bank, then clearly B Bank has a personal right to compel A Ltd to create the charge and A Ltd has an obligation to create it. Importantly, A Ltd also has the power to create a charge by virtue of the 1985 Act, s 462(1). But once creation happens, B Bank no longer has the aforementioned personal right and it does not (yet) have a real right in the property encompassed by the charge. Is the floating charge a conditional real right in security at this stage? And what does it mean to say that a floating charge is such a right? By definition, this right is not a real right in security until the relevant conditions are fulfilled. Likewise, a floating charge does not have real effect until the company enters receivership or liquidation, causing attachment, or until an administrator is appointed and an attachment event subsequently occurs. (The fact that these events, which change the charge’s nature, are also the starting point for enforcement, at least for liquidation and receivership, is another odd aspect of this form of security.)⁶⁴

If we focus on the attachment events as conditions, the floating charge between creation and attachment seems aligned with a certain type of conditional real right in security, one in which a real right is created automatically upon fulfilment of a condition.⁶⁵ This can be contrasted

⁶⁰ And presuppose that the charge is a real right upon attachment.

⁶¹ Using the “as if” statutory hypothesis in s 53(7) of the 1986 Act and the standard security mentioned in the definition of fixed security, in s 70(1) of the same Act, as the “guide” to the floating charge’s operation upon attachment and “by implication” its nature before attachment. The statutory hypothesis is also used in 1985 Act, s 463(2), and there is an accompanying definition of “fixed security” (s 486(1)).

⁶² Styles, “Two Types of Floating Charge” at 240f.

⁶³ Ibid at 241.

⁶⁴ As is the transformation of the charge’s nature in insolvency-related scenarios.

⁶⁵ This might include eg where A agrees to pledge property to B subject to fulfilment of a condition and, before fulfilment, the property is delivered to B: see Steven, *Pledge*, para 6-27.

with a right where the fulfilment of a condition only confers a personal right to compel another party to grant a real right.⁶⁶ However, even regarding the first-mentioned type, the floating charge is unusual because if, before the attachment condition is fulfilled, the grantor alienates its property, or grants other security rights,⁶⁷ this is not a breach of the chargeholder's right.⁶⁸ (Ordinarily, such actions would constitute a breach of the personal right of a party with a conditional real right in security.⁶⁹) This is because the floating charge is tied to the person of the debtor and its changing property, rather than specific property, while a "normal" conditional real security is dependent upon gaining an interest in a particular item of property. The latter is a right to receive a real right in specific property when a condition is fulfilled, whereas the floating charge is a conditional real right over non-specific property, as it applies to any property belonging to the chargor when attachment occurs (assuming all property is charged).

The floating charge has a divided nature;⁷⁰ but, whether it is a conditional real right following creation, or has attached and thus has real effect, it is still a floating charge.⁷¹ The division of creation and a floating charge's real effect causes Cabrelli to describe it as "truly unique" compared to other security rights.⁷² Cabrelli even declares it "perverse" to refer to the floating charge as a form of security in Scots law terms, as it "may never confer a real right in security".⁷³ Yet, when we consider the floating charge and the definition of security in a wider sense, it is clear that the possibility of attachment (as well as attachment itself) gives protection to the chargeholder, as do powers available to the chargeholder that can bring about attachment.

⁶⁶ An example would be where a party agrees to deliver property to create a pledge but only upon a condition first being fulfilled.

⁶⁷ A negative pledge will, however, enable a chargeholder to rank ahead of a subsequently created security but this will only have a property effect upon attachment (see further below).

⁶⁸ This has potential implications for the (non-)applicability of the "offside goals" rule. Separately, unfairly prejudicial transactions and gratuitous alienations could be challenged, but these are challengeable on the basis of the chargeholder as a creditor, rather than as a chargeholder.

⁶⁹ Unless it was contractually agreed that this would not be a breach.

⁷⁰ Its nature differs dependent upon whether it has attached or not.

⁷¹ Certain comparisons could be drawn with eg a standard security which exists under the 1970 Act upon granting but requires registration for a real right to be conferred (s 11(1)). Yet a floating charge requires creation, registration and attachment for effect against third parties. Cf pledge, which strictly speaking is the real right and cannot be a conditional real right.

⁷² D Cabrelli, "The Curious Case of the 'Unreal' Floating Charge" 2005 SLT (News) 127 at 127. This is true if we conflate the creation and registration of securities like the standard security, as per the 2006 Act, s 859(E)(1).

⁷³ Cabrelli (n 72) at 128.

(b) Rights or Powers?

A conditional real security, by itself, is passive and future-focused. It is therefore also necessary to consider what exercisable rights are actually held by a chargeholder before attachment. The holder has the power to petition the court to wind up the chargor company on the basis that “the security of the creditor entitled to the benefit of the floating charge is in jeopardy”.⁷⁴ A creditor’s security is considered to be in jeopardy “if the court is satisfied that events have occurred or are about to occur which render it unreasonable in the creditor’s interests that the company should retain power to dispose of the property which is subject to the floating charge.”⁷⁵ Of course, even without a floating charge a creditor can seek to have a debtor company placed into liquidation. But the existence of the floating charge gives an additional ground for doing so. The holder may also have the power to appoint a receiver over the charged property or to apply to court for a receiver to be appointed.⁷⁶ Administrative receivership has, however, largely been replaced by administration and the “holder of a qualifying floating charge”⁷⁷ has the power to appoint an administrator of the company, without the normal requirement to convince the court that the debtor is, or is likely to become, insolvent.⁷⁸ The exercise of each of these powers involves displacing the existing management of the chargor, as regards particular property or the company’s whole estate (patrimony), and replacing them with an alternative party. Not only this, but the successful exercise of the

⁷⁴ 1986 Act, s 122(2). There is an equivalent provision for unregistered companies (s 221(7)).

⁷⁵ Ibid, s 122(2).

⁷⁶ Ibid, ss 51(1) and (2) respectively. (The court approach is, understandably, far less common.) There is precedence amongst receivers appointed, based upon the ranking of the relevant floating charges: *ibid*, s 56(1).

⁷⁷ For the term’s meaning, see *ibid*, Sch B1, para 14(2) and (3). In essence, the charge instrument has to allow for the appointment of an administrator and the charge, alone or with other securities, must cover “the whole or substantially the whole” of the company’s property. These chargeholders also have rights and powers involving the appointment of administrators by the court: Sch B1, paras 35-37.

⁷⁸ *Ibid*, Sch B1, para 14(1). See the remainder of para 14 and para 15 for related conditions and for priority rules for appointment, which correspond to ranking. (Cf paras 10-13, which outline the rules that other creditors, including those with non-qualifying floating charges, must comply with to have an administrator appointed by the court.) The stipulation, in para 16, that an administrator may not be appointed if the charge is not enforceable must mean that the conditions in the charge instrument justifying the appointment of an administrator require to be met and/or that the charge has been validly registered and therefore is enforceable against a party such as an administrator (subject to attachment occurring). An alternative meaning, that it is not enforceable until attachment, would clearly be absurd, as attachment (outside liquidation and receivership) could only arise during the course of administration.

powers leads directly to the attachment of the floating charge (in the case of liquidation and receivership) or can do so indirectly and subsequently (in certain situations in administration).

Between creation and attachment the powers can either be conditional or exercisable (upon the fulfilment of the condition(s)). For example, the instrument creating a floating charge might provide that a receiver can be appointed in situation X. Before X occurs, the chargeholder's power is only conditional and is not exercisable, but this automatically changes once X takes place. In addition, the fulfilment of the conditions relating to the respective powers (to appoint an administrator or receiver or to seek the company's liquidation) differ as the conditions for each are not unified. Instruments creating the charges can specify exactly when a receiver or administrator may be appointed, but there are additional statutory possibilities for the appointment of a receiver,⁷⁹ and liquidation is limited to statutory grounds.⁸⁰

The above-noted powers (in addition to normal creditors' powers) are personal rights in a wide sense. However, they are not rights (or claim rights) in the strict Hohfeldian sense.⁸¹ There are no corresponding duties (or obligations) incumbent upon the chargor. For example, the chargor has no duty to appoint a receiver over its charged property. Instead, they have a contingent *liability* to have a receiver (or liquidator or administrator) appointed and the chargeholders have correlative Hohfeldian powers. It is instructive to compare these powers with the underlying secured debt, where there is a right and a duty; eg the right to receive repayment of a loan and the correlative duty to repay this. But this is one step removed from the floating charge itself. Indeed, many of the "rights" outlined in a charge instrument are separate from the charge proper.

The floating charge can be described as conferring powers to change the legal relations between the parties concerned. In this respect, there are similarities between the charge and the German legal concept of *Gestaltungsrecht*.⁸² Certain types of the latter, when exercised,

⁷⁹ Ibid, s 52. But see also ibid, Sch B1, paras 35-37.

⁸⁰ In comparison to English law where crystallisation is available in a wide range of situations, including as a result of automatic crystallisation clauses: see 47ff.

⁸¹ WN Hohfeld, "Some Fundamental Legal Conceptions as Applied in Judicial Reasoning" (1913-14) 23 YaleLJ 16; WN Hohfeld, "Fundamental Legal Conceptions as Applied in Judicial Reasoning" (1916-17) 26 YaleLJ 710.

⁸² See M Wolf and J Neuner, *Allgemeiner Teil des Bürgerlichen Rechts*, 11th edn (2016), 237; A von Tuhr, *Der Allgemeiner Teil des Deutschen Bürgerlichen Rechts*, vol 1 (1910) [reprinted 1997], 161.

provide a real interest in property.⁸³ And the exercisability of a *Gestaltungsrecht* can also be conditional, like a chargeholder's powers.⁸⁴ In addition, the exercise may be by the unilateral act of the holder of the power or by court action (*Gestaltungsklage*).⁸⁵ There appears to be some equivalence between these two different means of exercise and, for example: (i) the appointment of a receiver; and (ii) applying to the court either to put the chargor into liquidation or to have a receiver appointed. (The appointment of an administrator does not immediately lead to a change in the floating charge's nature but using this power can ultimately cause such a change and thereby alter the rights held by the parties involved.) Simply enforcing an existent right would not generally be considered a *Gestaltungsrecht*; however, the floating charge's enforcement brings about the transformation of the charge, and this comprises a change in legal relations between the parties. The German notion of *Anwartschaftsrecht* also appears relevant when examining the rights held by a chargeholder; they both involve a party acquiring an interest in expectation of obtaining a "full" real right in the future.⁸⁶ However, the immediate rights and protections for specific property given by *Anwartschaftsrechte* extend beyond those available to a chargeholder before attachment. These include the right of use and enjoyment of particular property, delictual rights against those who damage the property and some protection against the insolvency of the "owner".⁸⁷

⁸³ See eg von Tuhr, *Der Allgemeiner Teil* (n 82), 162, who refers to: "Befugnis, durch einseitiges Handeln Eigentum oder ein anderes dingliches Recht zu erwerben." Examples of *Gestaltungsrechte* relating to the acquisition of property rights under the BGB are §456 (Wiederkaufsrecht) and §463 (Vorkaufsrecht), which are a repurchase right and pre-emption right respectively, and §956(1) which allows an entitled party to obtain ownership of the products or components of a thing by taking possession. And see Wolf and Neuner, *Allgemeiner Teil* (n 82), 237.

⁸⁴ Eg in the case of pre-emption rights.

⁸⁵ Wolf and Neuner, *Allgemeiner Teil* (n 82), 239f.

⁸⁶ For details of *Anwartschaftsrecht*, see M-R McGuire, "National Report on the Transfer of Movables in Germany" in *National Reports*, vol 3 (2011), 28f, who notes that it can be translated as an "equitable interest"; and JF Baur and R Stürner, *Sachenrecht*, 18th edn (2009), 30ff and 843ff, who state at 30f: "... die Anwartschaft mehr ist als eine bloße Erwerbssaussicht, weniger als das Vollrecht."

⁸⁷ The floating charge requires attachment (and thus a change in its nature) to affect property directly in insolvency, albeit that attachment will be automatic upon liquidation or receivership.

(c) Transfer of the Floating Charge

Before attachment a floating charge itself may be transferred by assignation and intimation to the debtor,⁸⁸ the form of transfer used for personal rights.⁸⁹ This implies that a floating charge, even before attachment, is itself an item of property.⁹⁰ However, it is clear that it is not a typical claim right. Perhaps due to a floating charge's potential to become a real interest, it is presumed that even if the chargor and chargee agreed a prohibition on the charge's assignation, such a transfer by the chargee would be valid, albeit a contractual breach. By contrast, a claim right would be intrinsically limited and non-transferable by virtue of an agreement not to transfer.⁹¹

When we consider the floating charge from a general transfer perspective, it is a *sui generis* package consisting of: (i) conditional or unconditional personal powers regarding placing the chargor into liquidation, receivership or administration; and (ii) a conditional real interest relating to each item of charged property in the chargor's property and undertaking, the condition of which is purified when attachment occurs.⁹² These things are not synonymous but they cannot be separately transferred. It is the floating charge that is transferred and such

⁸⁸ Is the chargor. The extent to which the floating charge is accessory upon the underlying debt is unclear; 1985 Act, s 462(1), suggests that there needs to be a present or future obligation for the charge to secure and, at least initially, the chargeholder and the creditor of the secured obligation must be the same party. In *Libertas-Kommerz* the court accepted that the charge and the debt were both transferred under the assignation documentation, but they did not consider the accessoriness issue. And see the style assignation of a bond and floating charge in *Halliday's Conveyancing*, vol 2, para 56-31. See also *Joint Liquidators of Simclar (Ayrshire) Ltd v Simclar Group Ltd* [2011] CSOH 54; 2011 SLT 1131, in which a charge was assigned (after attachment) but without the chargeholder's debt also being assigned. For accessoriness more widely, see AJM Steven, "Accessoriness and Security over Land" (2009) 13 EdinLR 388.

⁸⁹ See *Libertas-Kommerz*; SLC, *1961 Act Memorandum*, para 62; SLC, *1961 Act Report*, para 19. Cf W Lucas, "The Assignation of Floating Charges" 1996 SLT (News) 203 who criticises the current position and proposes a registration requirement for the assignation of floating charges. Were it to come into force, the registration of an assignation of a floating charge would be provided for by 2007 Act, s 42. The provision was recommended by the SLC, *Registration Report*, para 2.20. And see chapter 9 for the transfer of personal rights.

⁹⁰ It is an item of property which could also be involuntarily assigned to a trustee in sequestration, prior to attachment, if the holder was a natural or legal person subject to sequestration. See eg the Scottish Government's *Explanatory Notes* to the 2007 Act, para 128.

⁹¹ See eg *James Scott Ltd v Apollo Engineering Ltd* 2000 SC 228. And see 234ff.

⁹² Although the chargeholder can change through transfer, the party subject to the charge cannot (even with the permission of the chargeholder). This is because it is not specific property that is charged, but the *chargor's* property at a future point. The alternative is also undesirable on registration and ranking grounds.

a transfer gives the transferee both (i) and (ii).⁹³ Indeed, the independent yet connected content of these atomised elements of the floating charge is shown by the fact that the exercise of (i) can fulfil the condition of (ii) but (ii) can be realised without the exercise of (i) (eg if the chargor is placed into liquidation upon the petition of another party), which can render the need to use (i) redundant or make it unavailable.

(3) Analogies

Analogies with other areas of Scots law fail to offer any clearer answers as to the floating charge's nature. The term "attach" did not have a single, clear, pre-existent meaning in Scots law before the floating charge was introduced,⁹⁴ but was (and is) sometimes used to describe the effect of certain diligences as akin to that of a real security.⁹⁵ This is in contrast to the more limited "litigious" effect of other diligences.⁹⁶ But litigiosity is of no assistance in describing the floating charge's relationship with property before attachment. The charge allows the debtor to transfer property and this would be prohibited by litigiosity.

Certain comparisons can be made between property in a trust and property over which a floating charge has been granted.⁹⁷ The chargor and trustee can deal with the property freely, the property fluctuates and changes, yet the chargeholder and beneficiary have potential interests in whatever property is held by the chargor or trustee at a given point. But a beneficiary has a vested or contingent personal right against the trustee as regards property in the latter's *trust* patrimony. By contrast, a chargeholder, prior to attachment, has certain conditional or unconditional powers, as well as a conditional real interest in property in the chargor's *private* patrimony.

⁹³ Also, in the unlikely event that a chargeholder's creditor wished to carry out diligence over the charge, (i) and (ii) would, seemingly, be conjointly subject to adjudication (Scots law's default diligence), given the inapplicability of other diligences.

⁹⁴ See eg "attachment" in *Bell's Dictionary*, 76, which is described as a judicial proceeding in English law, equivalent to arrestment in Scots law. (See also the related term "attachiamentum", at 76.) The term did not seem to be commonly used for voluntary security rights.

⁹⁵ See eg *Lucas's Trs v Campbell & Scott* (1894) 21 R 1096 per Lord Kinneir at 1101ff; and Bell, *Principles*, s 2272. See also n 1061 and accompanying text. It is also often stated that such a diligence creditor acquires a "nexus" over the property – see eg *Lord Advocate v RBS* in which both terms are used. The term "attach" is now most obviously applicable to the diligence of attachment, see Debt Arrangement and Attachment (Scotland) Act 2002, ss 10ff, which introduced this diligence.

⁹⁶ For discussion, see GL Gretton, "Diligence and Enforcement of Judgments" in *SME*, vol 8 (1992), paras 115f and 285f.

⁹⁷ In English law, a number of commentators have drawn comparisons between trusts and floating charges: see eg Nolan (n 19) and Goode, *Legal Problems*, para 4-04.

The landlord's hypothec has been described as a "form of floating security"⁹⁸ and does resemble the floating charge in particular ways, even though it is an implied security. The hypothec applies to changing assets and, formerly, its nature (apparently) altered when enforced by a special diligence, sequestration for rent, whereby the hypothec was "converted into an attachment of specific subjects...".⁹⁹ The abolition of sequestration for rent and the current statutory provisions suggest that the hypothec now has a unitary nature from its creation onwards,¹⁰⁰ but it is debatable whether the hypothec is now a real right or a preference.¹⁰¹ In any event, there remains a stronger argument for the hypothec being a real right in security, as the landlord still has certain rights or powers relating directly to particular property.¹⁰² Also, as the former nature(s) of the hypothec are under-researched and the current position has been referred to as a "theoretical mess",¹⁰³ the hypothec is (currently) of little help in analysing the floating charge.¹⁰⁴

(4) Negative Pledge

One final issue of note regarding the floating charge's nature before attachment is the status of the negative pledge. The inclusion of such a prohibition on the granting of prior or *pari passu* ranking security rights, in a floating charge instrument, enables the charge, upon attachment, to rank ahead of securities granted in breach of the prohibition.¹⁰⁵ This has the effect of ranking the floating charge from the date of its creation.¹⁰⁶ When interpreting the 1961 Act in *Telford*, Lord President Clyde considered that the fact a floating charge could rank from its registration date (which has subsequently been replaced by the creation date)

⁹⁸ R Rennie et al, *Leases* (2015), para 17.17. However, in its relationship with the floating charge it is a "fixed security arising by operation of law": see 230ff.

⁹⁹ Gloag and Irvine, *Security*, 430, and see, generally, 416ff. And see McAllister, *Leases*, para 6.6. Cf DA Brand et al, *Professor McDonald's Conveyancing Manual*, 7th edn (2004), para 25.94, where it is stated that only through sequestration for rent was the hypothec "converted into a real right".

¹⁰⁰ 2007 Act, s 208.

¹⁰¹ See McAllister, *Leases*, para 6.6, and the sources cited there.

¹⁰² For the remedies traditionally available, see GCH Paton and JGS Cameron, *The Law of Landlord and Tenant in Scotland* (1967), 212ff. Under the 2007 Act, s 208(2), the landlord's hypothec ranks in any insolvency or ranking situation as a right in security. And other remedies may still be available to the landlord – see McAllister, *Leases*, paras 6.13ff.

¹⁰³ McAllister, *Leases*, para 6.17.

¹⁰⁴ The same applies to the agricultural charge, which the Agricultural Credits (Scotland) Act 1929, s 6(1), states is enforced by sequestration and sale in the same manner as the landlord's hypothec.

¹⁰⁵ 1985 Act, s 464(1)(a) and (1A).

¹⁰⁶ See 23 for the meaning of creation.

supported the view that the charge was a real right.¹⁰⁷ However, this was in the context of analysing the nature of the charge upon attachment. The negative pledge cannot be considered to give the chargeholder a real interest prior to attachment: there are no property effects unless and until attachment occurs. Furthermore, the negative pledge is probably only binding on the acts of the chargor. Let us take an example: on day 1 A Ltd grants a floating charge, with negative pledge, over all of its present and future property, to B Bank; on day 2 C Ltd creates a pledge¹⁰⁸ over property P in favour of D Ltd; then on day 3 C Ltd transfers ownership of P to A Ltd. At some later point B Bank's floating charge attaches to P. Does the negative pledge enable B Bank to prevail over D Ltd's pledge?

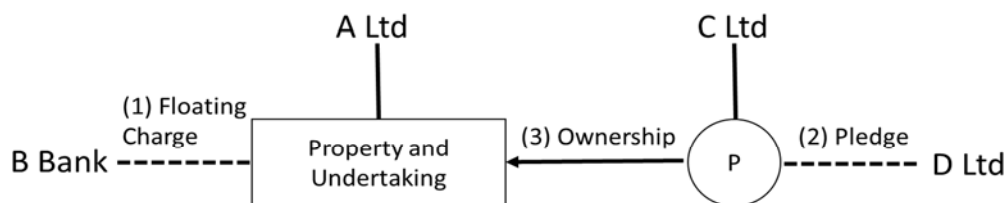

Clearly, if *A Ltd* (rather than *C Ltd*) had granted the pledge after the creation of the floating charge then B Bank would rank ahead. And the wording of the 1985 Act, s 464(1A), using a strict literalist construction, appears to lead to the same outcome in the example above, as it states that a negative pledge "... shall be effective to confer priority on the floating charge over *any* fixed security or floating charge created after the date of the instrument."¹⁰⁹ However, when we consider the matter purposively, an alternative, more appropriate, interpretation arises. The negative pledge is contained in an instrument agreed between the chargor and chargeholder and which principally comprises personal rights and obligations for those parties. Prohibitions or restrictions on granting (referred to in section 464(1)(a)) must surely be directed solely towards the chargor, as third parties have not agreed to be bound by the instrument, and the charge and the corresponding negative pledge only apply to the *chargor's* property from time to time. The negative pledge could only potentially have any effect on the

¹⁰⁷ See *Telford* per LP Clyde at 194f, referring to 1961 Act, s 5(2).

¹⁰⁸ This could be another fixed security, such as a standard security.

¹⁰⁹ Emphasis added.

property from when it enters the patrimony of A Ltd, by which point D Ltd's security already exists. Also, the charge is registered against A Ltd, rather than the property in question. Therefore, subjecting parties like D Ltd to the consequences of a breach of the prohibition seems manifestly unjust, as D Ltd could not be expected to search the charges register against A Ltd (a party with no discernible connection to the property at that time). The effect of section 464(1A) therefore ought not to extend to security rights subsequently granted by third parties over property which later enters the chargor's patrimony.¹¹⁰ The point has even greater weight if the 1961 Act is used for interpretive purposes, and if consistency across the different iterations of the floating charges legislation is sought. The 1961 Act provided that a fixed security would rank ahead of a floating charge unless, *inter alia*, the charge was already registered and the instrument creating the charge "prohibited *the company* from subsequently creating..." prior or equal ranking fixed securities.¹¹¹ The express reference to a floating charge with a negative pledge ranking from its registration date, was removed, without explanation, in the 1972 Act, and was not reinstated in the 1985 Act. This has led to a floating charge with negative pledge being interpreted to rank from its creation, considered (at least formerly) to be the date of its execution,¹¹² which has been reinforced by s 464(1A). This is unfortunate from a publicity and practical point of view.

A negative pledge confers on a chargeholder a contingent interest limited to ranking, which only affects property when attachment occurs and only as regards property in the chargor's property and undertaking at that point.¹¹³ It can be interpreted as having, upon attachment, retroactive effect from the creation of the charge, but probably only as regards security rights created by the chargor in breach of the negative pledge.¹¹⁴ Alternatively, it might be considered to immediately limit the power of the chargor to grant securities ranking ahead of the floating charge, but where the effects of such limitation are dependent on the charge attaching to the property.

¹¹⁰ The same should also apply to the following example. A Ltd owns P and grants a floating charge with negative pledge over P to B Bank, and then transfers P to C Ltd. C Ltd pledges P to D Ltd, before transferring ownership back to A Ltd. B Bank's floating charge then attaches to P.

¹¹¹ S 5(2)(c). Emphasis added. And see Scottish Standing Committee, 20 June 1961, cols 25-27, where Forbes Hendry noted that ranking from the date of the charge's registration (against other securities) was more appropriate than its date of execution, and this was considered to provide adequate notice to others. See also *Eighth Report*, para 51 and Appendix II, paras 4f.

¹¹² *AIB Finance* (n 14). But see 23 above and compare with s 464(1A).

¹¹³ As noted above, it does also have a pre-attachment ranking effect regarding priorities for appointing a receiver or administrator, but this is not directly property-related.

¹¹⁴ But note that the creation of a prohibited fixed security apparently extends to the act of registration in the Land Register after creation of the charge, even if that registration is by the fixed security holder and not the chargor: see *AIB Finance* (n 14).

C. CONCLUSION

The identification of the floating charge's nature before attachment is not a purely academic exercise. There are many contexts in which such classification can have practical implications: where there are external Scots law rules which apply dependent upon a particular classification;¹¹⁵ in the consideration of how to reform floating charges or areas of law interacting with floating charges; when dealing with new cases considering the effects of the floating charge; and in the categorisation of the floating charge in international private law.¹¹⁶ It also gives indications as to whether the charge is truly anomalous or if it can be integrated into existing Scots property law.

Between creation and attachment, a floating charge is not a real right; it only confers a potential interest in property belonging to the chargor at a future point. More precisely, it is a combination of different (but connected) personal rights, broadly defined to incorporate powers and conditional real interests. A floating charge with negative pledge also provides the chargeholder with a contingent ranking interest, which enables ranking from the date of the charge's creation, but which depends upon attachment for it to affect particular property.

¹¹⁵ Eg the application of doctrines, such as the "offside goals" rule, to the floating charge may be dependent upon how the charge is conceptualised. For details of the rule, see Reid, *Property*, para 695; and J Macleod, "The Offside Goals Rule and Fraud on Creditors" in F McCarthy, J Chalmers and S Bogle (eds), *Essays in Conveyancing and Property Law in Honour of Professor Robert Rennie* (2015), 115. Related to this, a prohibition on the transfer of particular property in the floating charge instrument would probably not be part of the floating charge *per se*, even if valid, but rather a separate obligation.

¹¹⁶ See eg C Bisping, "The Classification of Floating Charges in International Private Law" 2002 JR 195.

CHAPTER 3

ATTACHMENT EVENTS

A.	INTRODUCTION	45
B.	THE ATTACHMENT EVENTS	46
(1)	History	46
(2)	Current Law	47
(3)	Attachment Events and the Purpose of the Floating Charge.....	51
(4)	Publicity	53
C.	ATTACHMENT: EVENT AND PROCESS?	57
(1)	Acquirenda.....	57
(2)	Double Attachment.....	70

A. INTRODUCTION

The timing of attachment is significant. It is only from this moment that particular property is directly affected by the floating charge. The attached property might be different if the charge attaches on one particular date rather than sometime later. Between those two dates, the chargeholder could alienate or acquire property. In general, attachment is the point at which property must belong to the chargor to become attached. There is, though, uncertainty as to whether attachment also extends to property obtained after attachment initially takes place and whether multiple attachments of one charge are possible. These issues will be considered below.

First, however, it is necessary to outline the events that cause a floating charge to attach. Considering these events, and the development of the law in this area, helps us to comprehend the function and purpose of the charge, as well as the chronological disparity between the charge's attachment and accompanying publicity to third parties.

B. THE ATTACHMENT EVENTS

(1) History

Originally, it was only possible for the Scots law floating charge to attach upon liquidation of the chargor. The LRCS believed that introducing receivership would necessitate codifying English law on the matter, and would thus be too complicated.¹¹⁷ However, the SLC, when examining the issue a decade later, considered codification to be unnecessary and recommended receivership. It did so on the ground that a receiver might, in some instances, “revive the fortunes of a company and prevent unnecessary liquidation” and because the rights of a chargeholder were “weakened by his inability to take possession of and realise the security without liquidation”.¹¹⁸ Furthermore, the arrival of receivership would further align the laws of England and Scotland in this area; an apparently desired goal.¹¹⁹ Receivership was consequently introduced by the 1972 Act and the appointment of a receiver became an attachment event.¹²⁰

This change involved a significant empowering of chargeholders as the ability to appoint a receiver gave them greater control over when their floating charges would attach.¹²¹ Exercising this power also displaces the existing management and transfers their control of the company’s property to the receiver, a party of the chargeholder’s choosing. (A receiver acts as an “agent” of the company; however, he does so to realise assets to pay the chargeholder.)¹²² A further development, the general prohibition on administrative receivership introduced by the 2002 Act, has significantly curtailed the controlling power of the chargeholder.¹²³ This change represented a growing emphasis on survival of the company as a going concern and a belief that this could be better facilitated by a party running the

¹¹⁷ *Eighth Report*, paras 39f.

¹¹⁸ SLC, *1961 Act Report*, para 37. *Cork Report*, para 495, was also praiseworthy about the role of receivers in rescuing companies and being able to dispose of the business as a going concern. See also A Key and P Walton, *Insolvency Law: Corporate and Personal*, 3rd edn (2012), 88.

¹¹⁹ SLC, *1961 Act Report*, para 38.

¹²⁰ Ss 13(7) and 14(7).

¹²¹ Gretton (2003) (n 8) at 325, refers to the harm caused by the introduction of receivership and the fact that the receiver controls the debtor and acts for that party. He also refers to significant practical difficulties where the receiver is only appointed over some of the debtor’s property.

¹²² See 139ff.

¹²³ 1986 Act, s 72A, as inserted by 2002 Act, s 250(1).

business in the interests of all creditors, not just the chargeholder (as a receiver does).¹²⁴ Consequently, a chargeholder's general recourse is now to appoint an administrator, which does not automatically cause a floating charge to attach.¹²⁵ Despite the fact that administrators act in the interests of all creditors, there are often close links between them and charge-holding financial institutions.¹²⁶

(2) Current Law

Under the current law, a floating charge attaches upon: (i) the company going into liquidation,¹²⁷ (ii) the appointment of a receiver by the chargeholder¹²⁸ or by the court,¹²⁹ upon the chargeholder's application; (iii) a court consenting to a distribution by an administrator to a party other than a secured creditor, preferential creditor or towards the prescribed part;¹³⁰ and (iv) the delivery of a notice by an administrator to the registrar of companies specifying that, in the administrator's view, the company has insufficient property to enable a distribution to unsecured creditors (other than by virtue of the prescribed part).¹³¹

A receiver can still be appointed in certain circumstances. It can be done where the floating charge does not attach to the "whole or substantially the whole" of the company's property, in which case the receiver will not be an administrative receiver.¹³² There are also a number of specific exceptions to the prohibition on the appointment of an administrative receiver.¹³³

¹²⁴ For the purpose(s) of administration, see 1986 Act, Sch B1, para 3. For a critical perspective on administrative receivership, see Mokal, *Corporate Insolvency*, 208ff.

¹²⁵ See further below. Following proposals in the *Cork Report*, administration was first introduced into Scots law by the Insolvency Act 1985, ss 27 to 44, and consolidated in the 1986 Act, ss 8 to 27, but few used the regime before the 2002 Act reforms (which included the ability to appoint an administrator out of court for the first time). For details regarding the history of administration, see St Clair and Drummond Young, *Corporate Insolvency*, paras 5-01ff.

¹²⁶ See eg St Clair and Drummond Young, *Corporate Insolvency*, paras 5-05 and 5-80.

¹²⁷ 1985 Act, s 463(1). A company goes into liquidation "if it passes a resolution for voluntary winding up or an order for its winding up is made by the court at a time when it has not already gone into liquidation by passing such a resolution": 1986 Act, s 247(2).

¹²⁸ 1986 Act, s 53(7).

¹²⁹ *Ibid*, s 54(6).

¹³⁰ *Ibid*, Sch B1, para 115(1A)-(1B) in combination with Sch B1, para 65(3)(b). This attachment event was added by the 2015 Act, s 130(2).

¹³¹ 1986 Act, Sch B1, para 115(2) and (3). This attachment event was added by the 2002 Act, Sch 16.

¹³² See the combination of 1986 Act, ss 51, 72A(3), 251 and Sch B1, para 14. For discussion of the implications of restricting charged property before attachment, see St Clair and Drummond Young, *Corporate Insolvency*, para 6-03.

¹³³ 1986 Act, ss 72Bff.

And floating charges created before 15 September 2003 still give their holders the power to appoint an administrative receiver over the charged property, or to apply to the court for this.¹³⁴ The ability of such chargeholders to block the appointment of an administrator¹³⁵ led to some acquiring a charge for this very purpose: a so-called “lightweight floating charge”.¹³⁶ These chargeholders also, however, have the power to appoint an administrator instead, which might be preferable to receivership in certain instances.¹³⁷ As time passes, it may reasonably be expected that the volume of receiverships in Scotland will continue to decline. Yet, although there is a general downward trend, receiverships are still taking place each year.¹³⁸

Despite administration largely replacing receivership it is notable that the appointment of an administrator does not cause a floating charge to attach.¹³⁹ Instead, when we consider the administration attachment events above, what underlies attachment in administration is either: (a) that a court has consented to a lower-ranking party receiving a distribution; or (b) that there are insufficient assets to pay parties ranking below the chargeholder. The charge therefore attaches to protect the ranking preference of the chargeholder in a distribution context and to enable a distribution to be made to the chargeholder.¹⁴⁰ As Cabrelli has pointed out, there is a strong argument that floating charges ought to attach upon an administrator’s appointment, as

¹³⁴ 1986 Act, s 72A(4) and Insolvency Act 1986, Section 72A (Appointed Date) Order 2003/2095, Art 2.

¹³⁵ An administrator cannot be appointed where there is an administrative receiver, unless the person appointing the receiver consents (or in certain other cases relating to challengeable transactions) – 1986 Act, Sch B1, paras 17(b) and 39(1).

¹³⁶ See St Clair and Drummond Young, *Corporate Insolvency*, para 5-28; and Cabrelli (n 8) at 414. However, the existence of a *non*-administrative receiver does not seem to stop the appointment of an administrator – 1986 Act, Sch B1, paras 17(b) and 39(1); and para 41(1) provides that an administrative receiver shall vacate office when an administration order takes effect, while 41(2) states that a receiver of part of the company’s property shall vacate office only “if the administrator requires him to”.

¹³⁷ Although an administrator’s appointment does not cause a charge to attach and he acts in the interests of all creditors, there are certain circumstances in which it is advantageous for a chargeholder to appoint an administrator. Notably, administration is expressly included by Regulation (EU) 2015/848 on insolvency proceedings (Recast Insolvency Regulation), while receivership is not (see Annex A).

¹³⁸ The most recent statistics available from the Accountant in Bankruptcy are for 2015-16, when there were 4 receiverships. In 2014-15 there were 6, in 2013-14 there were 10, and in 2012-13 there were 31. By contrast, 122 receiverships were recorded in 2002-3. See

<https://www.aib.gov.uk/about/statistics-data/aib-corporate-insolvency-statistics-2000-present>.

¹³⁹ This means that in administration the charge is unattached. By statutory provision, it no longer covers property disposed of by the administrator, but does encompass property acquired by the company in place of that property disposed of: 1986 Act, Sch B1, para 70.

¹⁴⁰ See eg Sch B1, paras 115 and 116. And see eg the *Explanatory Notes* to the 2015 Act, paras 747ff. In terms of paras 115(1) and 116(e) it seems that only attached charges allow for distribution.

was thought to be the case in England.¹⁴¹ However, there is now growing support for the view that, unless a provision in the charge agreement provides otherwise, the appointment of an administrator does not cause a charge to crystallise in English law.¹⁴² It may, nevertheless, be queried why the appointment of an administrator does not cause a floating charge to attach in Scots law. This outcome would be consistent with the position for attachment upon liquidation and receivership and would align the real effect of a floating charge with the commencement of a process that is being used for the charge's enforcement. If attachment did take place upon administration, policy considerations regarding the use of administration as a recovery process for companies would probably need to be taken into account when formulating the law. This issue could be (partially) addressed by providing that a charge that had attached upon administration would "re-float" when the chargor exited that process. Under the current law the need for such a rule is obviated and an administrator also has the convenience of being able to dispose of charged property as if it were not subject to the charge,¹⁴³ but this power could be preserved even if administration caused immediate attachment of a floating charge.¹⁴⁴

Cabrelli also considers whether non-attachment upon administration in Scots law can be circumvented by an "automatic attachment" clause. He rightly doubts that a Scottish court would accept the automatic attachment of a floating charge based upon agreement by the chargor and chargee.¹⁴⁵ Floating charges are a statutory creation in Scots law and all of the

¹⁴¹ Cabrelli (n 72). The law has not been changed to accommodate this suggestion.

¹⁴² See eg Goode, *Legal Problems*, para 4-45. (The previous edition, L Gullifer (ed), *Goode on Legal Problems of Credit and Security*, 4th edn (2008), paras 4-37 and 4-42, suggested that appointment of the administrator by the debenture holder did crystallise the charge.) The apparent justification of the position outlined in the current edition, is that the administrator acts in the interests of a wide range of parties (with corresponding duties), not just the chargeholder, and can dispose of charged assets without the court's leave. Thus, the chargeholder arguably does not exercise control through the appointment of an administrator alone (see the categories of crystallisation specified in n 149 below). See also Goode, *Principles of Corporate Insolvency*, para 11-30; Goode, *Commercial Law*, para 25.17. Cf G Lightman and GS Moss, *The Law of Administrators and Receivers of Companies*, 5th edn (2011), para 3-062.

¹⁴³ 1986 Act, Sch B1, para 70. By contrast, if an administrator wishes to dispose of property that is subject to a fixed security as if it were not subject to that security, a court order is required: 1986 Act, Sch B1, para 71.

¹⁴⁴ Indeed, the 1986 Act, Sch B1, para 70, is not expressly limited to unattached floating charges and therefore presumably also applies to attached charges, despite the fact that a floating charge attaches as if it were a fixed security. See also 1986 Act, s 251, which provides that a floating charge "means a charge which, as created, was a floating charge and includes a floating charge within section 462 of the Companies Act".

¹⁴⁵ Cabrelli (n 72) at 130f. He cites the obiter views of Lord Penrose in *Norfolk House Plc (In Receivership) v Repsol Petroleum Ltd* 1992 SLT 235. Cabrelli's position is also supported by the *Explanatory Notes* to the 2015 Act, paras 748f. Cf DA Brand et al, *Professor McDonald's Conveyancing Manual*, 7th edn (2004), para 34.7.

attachment points are also statutorily defined.¹⁴⁶ No express power is given by statute to parties to agree a separate attachment event, either through notice by the chargeholder or automatically upon an event occurring. Furthermore, the rejection of floating charges at common law and the absence of publicity, in spite of the purported creation of a real interest upon attachment, negates the possibility of there being a non-statutory power that enables a charge to attach. A functionally similar alternative is possible where receivership is available; the parties can agree precisely when receivership may take place. Yet this will still involve a delay (albeit a potentially very short one) between the event allowing for receivership and attachment, as the chargeholder must still take the active step of appointing the receiver.¹⁴⁷

The Scottish position on automatic attachment can be contrasted with England where authorities provide that contractually-agreed automatic crystallisation is effective, as is crystallisation where notice is given by the chargeholder in accordance with the charge agreement.¹⁴⁸ In general terms, the attachment events in Scots law are far narrower and more limited than in England, where they are numerous and varied.¹⁴⁹ This is due to the statutory constrictions of attachment in Scotland, in comparison to the contractual and equitable origins and development of the English floating charge. Scots law also places a higher value on publicity to third parties than English law and it is therefore understandable that contractually agreed crystallisation is permissible in English law but not in Scots law. To allow such crystallisation in Scotland would exacerbate some of the issues involving the floating charge's relationship with property law and would mean that a charge could have priority over competing rights due to a "private" attachment event that involves even less publicity than the existing attachment events (see further below). In addition, it would increase uncertainty as to whether a floating charge had already attached at any given point and could therefore impact upon the willingness of third parties to transact with the chargor.

¹⁴⁶ See eg Bennett, "Companies", para 166; Paisley, *Land Law*, para 11-27.

¹⁴⁷ See 1986 Act, s 52.

¹⁴⁸ See *Re Brightlife Ltd* [1987] Ch 200. SD Girvin et al, *Charlesworth's Company Law*, 18th edn (2010), para 25-015; Goode, *Legal Problems*, paras 4-53ff. But see paras 4-57ff, for some drawbacks relating to automatic crystallisation clauses.

¹⁴⁹ See eg Goode, *Legal Problems*, paras 4-31ff. There, crystallising events are placed into three categories (excluding agricultural charges): (1) events denoting cessation of trading as a going concern; (2) intervention by debenture holder to take control of assets; and (3) other acts or events specified in the debenture as causing crystallisation.

(3) Attachment Events and the Purpose of the Floating Charge

The traditional explanation of the floating charge's principal purpose is that it is a device used to give security, over a range of property, by way of ranking priority. This view has been challenged, in relation to English law, by the likes of Mokal, who describes the floating charge as a "residual management displacement device" (for the replacement of failed or failing management), which works optimally only as part of a "package of security interests" over all, or the majority of, the chargor's property.¹⁵⁰ He therefore emphasises a control-based explanation of the charge rather than a traditional priority-based one.¹⁵¹ In other words, parties seek to obtain a floating charge primarily because of the control it offers them over the chargor's business, rather than to give a security preference over property. This is partly because of the low-ranking priority of the English floating charge and the consequent limitations on how much chargeholders tend to recover, as displayed by certain empirical evidence.¹⁵² As Mokal notes, the value of the charge has also diminished due to changes arising from the 2002 Act, including the general replacement of receivership with administration.¹⁵³ But to what extent is Mokal's analysis applicable to the floating charge in the Scottish context?

The use and function of the Scots law floating charge have, to some extent, developed in accordance with the changing means of attachment and enforcement. Originally, the limitation of attachment to liquidation meant that the primary value of the charge was as security over a range of property in the chargor's insolvency (in combination with allowing the chargor freedom to trade up to this point). The introduction of receivership made the floating charge more of a dual-purpose device, based upon control as well as its priority effect. The chargeholder could thereafter appoint a receiver (or apply to the court for such appointment) as the controller of charged property and the receiver would act in the interests of the chargeholder and seek to make distributions to it. The appointment can occur at a time of the

¹⁵⁰ Mokal, *Corporate Insolvency*, 194.

¹⁵¹ Ibid, 195ff. In doing so he refers to J Armour and S Frisby, "Rethinking Receivership" (2001) 21 OJLS 73 at 90 (who note that it is "conceptually possible" to imagine a system in which a floating charge confers only "control rights" and no priority benefits); and J Franks and O Sussman, "The Cycle of Corporate Distress, Rescue and Dissolution" (IFA Working Paper 306, 2000), 6.

¹⁵² See Mokal, *Corporate Insolvency*, 191f and the sources cited there. Cf K Akintola, "What is Left of the Floating Charge? An Empirical Outlook" (2015) 7 JIBFL 404, who uses more recent empirical data on administrations to challenge the notion that insolvency law has limited the charge to being a "control/management-displacement device".

¹⁵³ Mokal, *Corporate Insolvency*, 219ff.

chargeholder's choosing, so long as agreed or statutory conditions have been fulfilled. Even with the general abolition of administrative receivership, appointing a receiver remains an attractive proposition for the control it confers and, therefore, a limited-assets floating charge is sometimes sought by a lender.

The largescale replacement of receivership with administration has, however, diminished the traditional security function of the charge. Anderson and Biemans suggest that a floating charge is now largely used in Scotland (and England) as a “residual security document”, the “primary utility” of which is to provide the chargeholder with a power to appoint an administrator.¹⁵⁴ Certainly, the function of the floating charge in Scotland has shifted, in relative terms, away from a security function towards control (even though administration gives a chargeholder less absolute control than receivership). This is largely because, unlike with receivership, attachment and corresponding priority effects and distribution requirements are not connected directly to the onset of administration. But the floating charge's security function still retains significance, particularly compared to England. In English law, a wider range of alternative security rights is available and in Scots law there are inconvenient formalities for creating other security rights. One can therefore speculate that floating charges in Scotland are still often obtained to confer a ranking priority. The ranking preference of a Scottish floating charge with negative pledge against later fixed securities, in contrast to the more nuanced ranking relationships in England,¹⁵⁵ also supports this conclusion. Unfortunately, there is an absence of collated data regarding recovery percentages by chargeholders under Scots law, relative to other security holders, preferential creditors and unsecured creditors. This means it is difficult to use empirical evidence to bolster a particular explanation of the Scottish floating charge, including in comparison to the English version.¹⁵⁶

¹⁵⁴ RG Anderson and J Biemans “Reform of Assignment in Security: Lessons from the Netherlands” (2012) 16 EdinLR 25 at 32.

¹⁵⁵ The ranking position of floating charges in English law has, however, been somewhat improved (since 6 April 2013), as the existence of a negative pledge now requires to be disclosed to the registrar in a statement of particulars, and the information appears on the charges register (2006 Act, s 859D). Persons who consult that register are likely to be considered to have notice of the negative pledge, and this can have ranking consequences: see Goode, *Commercial Law*, para 24.47ff. It is also interesting to ponder the impact of this bolstering of the floating charge's ranking priority with respect to Mokal's thesis (see above).

¹⁵⁶ Mokal, *Corporate Insolvency*, 191f, used data of recoveries by secured creditors, preferential creditors and unsecured creditors to ascertain how much a chargeholder recovered under the pre-2002 Act law. The equivalent data for Scotland in R3, *9th Survey of Business Recovery in the UK* (2001), 27, is “marginally too small to be statistically sound but still provides indicators and trend analysis.” The statistics are, however, consistent with the view that floating charges have more of a priority purpose in Scots law than in English law. Unfortunately, post-2002 Act figures are unavailable. More

What is certain is that the move towards administration has also diminished the chargeholder's control over the precise timing of the charge's attachment.

Finally, in Scotland (as in England) creditors often obtain fixed securities over various items of property, especially immovable property, in addition to the floating charge. This gives creditors more control and protection over specific items: the debtor will be subject to various restrictions regarding the use of the property; the property cannot be sold unencumbered without the creditor's permission; and fixed securities rank ahead of preferential creditors and are not postponed to a prescribed part. Having a floating charge as well as fixed security is of value as the charge allows a creditor to obtain an interest in a wider range of property than fixed security (in practical terms). The charge's enforcement mechanisms offer a further advantage, especially in comparison to the relatively cumbersome enforcement procedures for a standard security.¹⁵⁷

(4) Publicity

The timing of attachment can cause practical difficulties because, just as there is an absence of publicity accompanying the creation of the floating charge, there is often a lack of publicity upon attachment.¹⁵⁸ Given that attachment has real effect, and thus impacts upon the rights of third parties, some form of registration (or equivalent) should always be a precondition for attachment. This would adhere with the Scots law publicity principle, whereby some form of public act is necessary to establish a real right. Such an act would provide a means of notice for third parties who might wish to transact with the chargor but who would be adversely affected by an attached charge. In general terms, greater certainty would be provided to all

up-to-date information for the UK as a whole (received 3 November 2015), acquired via a Freedom of Information request to the Insolvency Service, shows that in a sample of 165 administrations from 2012-13, secured creditors (excluding floating charge holders) received 50% of their debt; preferential creditors 26%; floating charge holders 13%; and unsecured creditors 0.3%. In a number of these cases the chargeholder also held another security right (or rights) and the recovery percentages correspond to how much was recovered due to the floating charge and the other security right(s) respectively.

¹⁵⁷ It would even be possible for the same creditor to take a limited assets floating charge over certain heritable property along with a higher-ranking standard security. This would seem to allow for enforcement through the appointment of a receiver but with the secured creditor receiving proceeds in priority to, *inter alia*, preferential creditors and the prescribed part, due to the secured creditor holding the prior-ranking standard security.

¹⁵⁸ See eg SLC, *Sharp Report*, paras 5.1ff, for criticism.

interested parties, and the costs of discovering the true status of the charge would be minimised.

Presently, when a chargeholder appoints a receiver the charge attaches immediately; however, there is a period of seven days within which a copy of the instrument of appointment, and a notice, must be delivered to the Accountant in Bankruptcy and registrar of companies, for registration purposes.¹⁵⁹ There is thus a chronological disparity between attachment and registration. And even the failure to register in the time period will only lead to a fine¹⁶⁰ rather than invalidating or delaying the attachment in any way. There are equivalent registration and penalty provisions which apply after the appointment of a receiver by the court.¹⁶¹ When the SLC recommended the introduction of receivership, they had proposed that a receiver would only be appointed, and therefore a floating charge would only attach, when the registrar of companies issued a certificate of appointment of the receiver.¹⁶² However, a less publicity-conscience model, in line with English law, was chosen.¹⁶³

Where a company goes into liquidation upon the making of a court winding-up order, a copy of that order is to be sent “forthwith” to the registrar of companies¹⁶⁴ and Accountant in Bankruptcy.¹⁶⁵ (This is in addition to the earlier publicity requirements relating to the petition for winding up.)¹⁶⁶ But, again, there might be a delay between the attachment of a charge and the registration of the attachment event, albeit that the court proceedings would provide some form of notice to existing interested parties. And if the winding up is voluntary, the company has to give notice in the *Edinburgh Gazette* within 14 days after the passing of the resolution,

¹⁵⁹ 1986 Act, s 53(1); Scotland Act 1998, Sch 8, para 23. And see *Greene and Fletcher: Receivership*, paras 10.01ff; and McKenzie Skene, “Corporate Insolvency”, para 155.

¹⁶⁰ 1986 Act, s 53(2).

¹⁶¹ *Ibid*, s 54(3); Scotland Act 1998, Sch 8, para 23. And see McKenzie Skene, “Corporate Insolvency”, para 156.

¹⁶² SLC, *1961 Act Report*, para 51.

¹⁶³ See also the comments by E Marshall on the 1972 Act, ss 13 and 14, in *Current Law Statutes Annotated 1972* (1972). For registration of the appointment of a receiver under English law now, see 2006 Act, s 859K.

¹⁶⁴ 1986 Act, s 130(1). When the floating charge was introduced, in 1961, the relevant time periods were different; however, the LRCS (*Eighth Report*, para 52) did not identify the problem raised by the time delay between attachment and the attachment event’s publication through registration.

¹⁶⁵ Scotland Act 1998, Sch 8, para 23.

¹⁶⁶ See McKenzie Skene, “Corporate Insolvency”, para 243, for details.

otherwise the company and its officers are subject to a fine.¹⁶⁷ Likewise, these parties are subject to a fine if there is a failure to file a copy of the resolution with the registrar of companies and the Accountant in Bankruptcy within 15 days of the passing of the resolution.¹⁶⁸

Attachment in administration, in the form of event (iv) above, more closely complies with the publicity principle; a notice filed by the administrator with the registrar of companies causes attachment.¹⁶⁹ However, the other situation in which a charge attaches in administration, where the court gives permission for a distribution to certain creditors, involves no meaningful publicity to third parties.¹⁷⁰

As well as there often being no reasonable means by which a third party can tell immediately that a floating charge has attached, the differing forms and timing of registration (or equivalent acts) following attachment are unnecessarily non-uniform and disjointed. Making registration in the charges register a compulsory constitutive act for attachment of a floating charge, irrespective of the enforcement method, would resolve these issues. The SLC recommended the introduction of a “no attachment without registration” principle across all types of enforcement mechanism.¹⁷¹ However, the continued non-operation of Part 2 of the 2007 Act has precluded this reform, given that the SLC’s recommendation depended upon the new regime of registration in the Register of Floating Charges.

Certain floating charge provisions in the 2007 Act would bring the charge further into conformity with the publicity principle in another respect: creation of a charge would only occur upon the registration of a document granting the charge (in the proposed Register of

¹⁶⁷ 1986 Act, s 85(1) and (2). But it is another matter whether offences under the legislation are actually prosecuted. And see 1986 Act, s 109; and Scotland Act 1998, Sch 8, para 23, for the notice requirements once a liquidator is appointed.

¹⁶⁸ 1986 Act, s 84(3) applying 2006 Act, ss 29, 30; Scotland Act 1998, Sch 8, para 23.

¹⁶⁹ 1986 Act, Sch B1, para 115(2) and (3). Also note the publicity requirements for administration itself – 1986 Act, Sch B1, paras 18(1) and 46; and see the earlier notice requirements detailed in McKenzie Skene, “Corporate Insolvency”, paras 63ff.

¹⁷⁰ 1986 Act, Sch B1, para 115(1A) and (1B).

¹⁷¹ SLC, *Sharp Report*, paras 5.2ff. And see the clauses in the proposed Attachment of Floating Charges etc (Scotland) Bill appended to the Report, at Appendix A.

Floating Charges).¹⁷² Under the current law, registration is not a precondition for either creation or attachment. There is, consequently, the possibility of “invisibility” periods; where third parties cannot tell from the register whether a floating charge has been created or attached.¹⁷³ Absurdly, a charge could even be created *and* attach before *any* registration takes place.¹⁷⁴

The problems created by the absence of publicity accompanying attachment mean that practical workarounds have to be resorted to. Most obviously, a third party acquiring property from a chargor will often seek a certificate (or letter) of non-crystallisation from the chargeholder. In this certificate the chargeholder will commonly state that the charge has not attached and that it will not be made to attach for a specified period of time.¹⁷⁵ The precise legal effect of such certificates is not certain and a chargeholder could be unwilling to provide what has been requested or they could simply fail to respond or the transaction might not be completed when the specified time period expires. It is unfortunate that the law requires third parties to resort to this relatively unsatisfactory solution. A regime whereby a floating charge could only be created and attach upon registration would not only better integrate the floating charge into Scots property law, it would also provide more certainty. If a third party could rely on public registration to discover the status of a charge, it would minimise the costs of trying to discover whether the charge had attached and would reduce the need to seek (related) information from the chargeholder.

¹⁷² S 38(3). (But there would be certain special exceptions – see s 38(3A)-(3B)). A 21-day advance notice period would also be possible (s 39).

¹⁷³ Although the issue is not free from difficulty, within the registration period after creation (see 2006 Act, s 859A and chapter 1) it seems that a not-yet registered security is valid against all parties, but is rendered invalid against various parties if there is a failure to register within the time limit.

¹⁷⁴ This unlikely event would arise if there was attachment prior to the expiry of the registration period after creation. (Registration within that period would still, however, probably be necessary.) The registration of the attachment event could also, apparently, occur before the registration of the charge’s creation.

¹⁷⁵ See e.g. Gretton and Reid, *Conveyancing* (n 526), para 28-09. As Gretton and Reid note, it is also often advisable for the certificate to contain the chargeholder’s express consent to the sale.

C. ATTACHMENT: EVENT AND PROCESS?

A floating charge attaches to property held by the chargor at the point of attachment.¹⁷⁶ Property which was earlier disposed of is not attached. But what is the status of property acquired after attachment? Is attachment a single event which only strikes property held when the charge first attaches, or is it also an ongoing process affecting certain newly obtained property the instant that property belongs to the chargor? This necessitates consideration of whether “acquirenda” are attached. Although relatively rare now, the following section focuses on receivership, as it featured in the leading case on the issue (and in subsequent commentary), and is more likely to involve post-attachment acquirenda than liquidation or administration. This is due to the combination of the receiver’s role in managing the company’s business (which is greater than a liquidator’s) and the fact that a floating charge will have already attached (unlike in an administration).

Acquirenda issues revolve around examining the consequences of one attachment event; however, what must also be considered is whether it is possible for a charge to attach on more than one occasion. And can a charge “re-float” and attach at a future point? The answers to these questions allow us to determine if attachment is a singular irreversible change in the charge’s nature or whether the charge retains a residual floating effect and/or its attachment transformation can be reversed. These matters will therefore be explored later in this section.

(1) Acquirenda

According to *Ross v Taylor*,¹⁷⁷ the answer to whether acquirenda are attached depends upon if the attachment event is liquidation or receivership.¹⁷⁸ In *Ross*, a company had entered

¹⁷⁶ As DP Sellar, “Future Assets and Double Attachments” (1985) 30 JLSS 242 at 243, notes, this includes not only vested rights, but even *spes*. Sellar explains this on the basis that the charge has effect as an assignation in security and such property can be assigned in security, but notes that, due to the requirement of intimation, only “contemplated” contingent rights will be attached. Alternatively, one could simply say that everything deemed “property” in Scots law may be attached by the charge (see chapter 4).

¹⁷⁷ 1985 SC 156.

¹⁷⁸ Per LP Emslie at 161f. For discussion, see: St Clair and Drummond Young, *Corporate Insolvency*, paras 6-08f; *Greene and Fletcher: Receivership*, para 2.37ff: and see McKenzie Skene, “Corporate Insolvency”, para 164.

receivership and subsequently liquidation. The (then-applicable) receivership provisions provided that the floating charge attached “to the property then subject to the charge”,¹⁷⁹ and this was interpreted as tying the attachment of newly acquired property to the continuing effectiveness of the instrument of charge. Since the instrument subsisted until some point after the commencement of the chargor’s liquidation, and it expressly covered all of the chargor’s property, the charge was held to attach to property acquired by the chargor after the receiver’s appointment. This was contrasted with the position for liquidation, the provisions for which stated that the floating charge attached “to the property then comprised in the company’s property and undertaking”.¹⁸⁰ That wording was believed to limit attachment to property held at the moment liquidation commenced.

The court’s emphasis on the content of the charge instrument overstates what can be agreed by the parties regarding the charge’s coverage; in Scots law its extent is statutorily limited. This contrasts with the more contractually and equitably-driven English position,¹⁸¹ where it has been held that a debenture that created a charge extended to choses in action obtained by a receiver after crystallisation.¹⁸² (However, it is possible to read the case as involving the shifting of the crystallised charge from goods sold to post-crystallisation choses in action arising from such sale, which might be consistent with the Scots law position outlined below). The words “property *then* subject to the charge”¹⁸³ in the Scottish receivership provisions (present and past),¹⁸⁴ in combination with the fact that the provisions apply at the moment when the receiver is appointed and the charge attaches, raise doubt as to whether *acquirenda*

¹⁷⁹ 1972 Act, s 13(7).

¹⁸⁰ *Ibid*, s 1(2).

¹⁸¹ Which makes the English floating charge more flexible and less narrow than the Scottish version. Goode, *Legal Problems*, para 4-66, notes: “The [English] floating charge owes nothing to statute; it is the pure creation of equity judges of the nineteenth century”. There are other examples of the difference, such as in relation to “partial crystallisation”, which is possible in England (but only if such a power is conferred by debenture) (see eg Goode, *Legal Problems*, paras 4-49 and 4-61), but not in Scotland, as attachment, by virtue of the legislation, is automatically to all property covered by the charge at the given time (see eg St Clair and Drummond Young, *Corporate Insolvency*, para 6-08, for receivership) and there is no scope for contrary contractual agreement.

¹⁸² See the majority decision in *NW Robbie & Co Ltd v Witney Warehouse Co Ltd* [1963] 1 WLR 1324. See also Goode, *Legal Problems*, para 4-32. In *Ross* the court suggested *NW Robbie* and *Re Yagerphone Ltd* [1935] Ch 392 were limited to their facts and the content of the respective debentures. However, a debenture-focused approach (combined with statutory interpretation), nevertheless, seems to have been influential in *Ross*.

¹⁸³ Emphasis added.

¹⁸⁴ 1972 Act, s 13(7) and 14(7); 1986 Act, ss 53(7) and 54(6).

were truly intended to be covered.¹⁸⁵ But it is notable that the word “then” is missing from the administration attachment provisions, which suggests that the reasoning in *Ross* applies more forcefully in that context.¹⁸⁶ Yet, even the relevant wording for administration can still be read as referring to property charged at the moment of attachment.

The differing wording in the receivership and liquidation contexts is still applicable in the current legislation. It has been contended that there is no legal significance in this divergence and McKenzie Skene also notes that it is not obvious whether the result in *Ross*, regarding acquirenda, would apply to the current receivership provisions.¹⁸⁷ However, despite recognising the changes in legislative wording over time, St Clair and Drummond Young suggest it is “clear”, following *Ross*, that future assets of a company are attached in receivership.¹⁸⁸ Bennett argues in favour of uniformity across liquidation and receivership for acquirenda, stating that a chargeholder should not be prejudiced because of attachment in liquidation rather than receivership.¹⁸⁹ Sellar similarly queries why receivership, introduced as an additional floating charge enforcement mechanism, should extend the chargeholder’s security.¹⁹⁰ The argument in favour of uniformity of attachment ought to also apply to administration.

Bennett is sceptical too regarding the correctness of floating charges attaching to anything beyond the rights held at the point of attachment.¹⁹¹ It is certainly difficult to see why a chargeholder should receive a bonus of additional property in comparison to other creditors of the company.¹⁹² The chargeholder has control over when it wants to appoint a receiver or

¹⁸⁵ This argument was made (unsuccessfully) by counsel for the liquidator in *Ross* (at 161). See also *Palmer’s Company Insolvency*, para 207.

¹⁸⁶ 1986 Act, Sch B1, para 115(1B) and (3).

¹⁸⁷ McKenzie Skene, *Insolvency*, 169. And at 154, n 43, the author agrees with the apparent doubt expressed by St Clair and Drummond Young, *The Law of Corporate Insolvency in Scotland*, 2nd edn (1992), 139 (now 4th edn (2011), para 6-08), that the difference between the receivership and liquidation wording regarding attachment has “legal import”.

¹⁸⁸ St Clair and Drummond Young, *Corporate Insolvency*, para 6-09.

¹⁸⁹ *Palmer’s Company Insolvency*, para 207.

¹⁹⁰ Sellar (n 176) at 243.

¹⁹¹ *Palmer’s Company Insolvency*, para 207. See also G Morse (ed), *Palmer’s Company Law*, 25th edn (Looseleaf), para 13.209.2.

¹⁹² However, preferential creditors will, of course, rank ahead of the chargeholder and so will usually not lose out.

administrator and its general position of strength should not be further fortified by enabling it to have a priority interest in acquirenda.

(a) Realisation

Yet the legitimacy of the argument that the chargeholder should not have a claim to acquirenda, as it would benefit unfairly, depends upon what we mean by “acquirenda”. Clearly, if attached property is sold, the chargeholder has a right to the proceeds.¹⁹³ This “realisation” is necessary to satisfy the debt due to a chargeholder. Indeed, it is only by virtue of a liquidator, receiver or administrator having the power and duty to realise attached property, and distribute, that a chargeholder can receive payment for sums due.

(b) Conversion

Beyond simple realisation of attached assets, much property received after attachment will, in some way, be connected to attached property. One type of situation generating such post-attachment property is “conversion”;¹⁹⁴ where attached property is exchanged for another item of property (other than monetary proceeds). Let us take an example. A Ltd grants a floating charge, over all of its property and undertaking, to B Bank. A Ltd agrees a contract for C Ltd to supply expensive machinery. Under the terms of the agreement, A Ltd is to make payment on a certain future date, and will receive ownership of the machinery upon such payment. However, before that date, B Bank appoints a receiver, R, to A Ltd. R considers that the contract is a bargain and therefore makes payment and A Ltd acquires ownership. The money used for payment had been attached by the floating charge. Where there is direct exchange of property, as in this case, there is a strong argument in favour of the charge attaching to the received property. The charge affects proceeds of attached property sold, and it ought to also affect other property acquired in return for charged property. It would, of course, be unjustifiably prejudicial to the chargeholder if property acquired in exchange for attached property was not itself attached. Indeed, the fact that the receiver is only appointed in relation to attached property, and therefore can only deal with these items, suggests that any property

¹⁹³ Indeed, 1986 Act, s 60(1), premises distribution to the chargeholder on the basis of moneys obtained by a receiver. See also *ibid*, Sch B1, paras 115-116, for administration.

¹⁹⁴ As this involves replacement of one piece of property with another, it fits into the wider concept of real subrogation.

obtained in the course of a receiver's work with charged property ought to be covered by the charge.¹⁹⁵ And, in statutory terms, newly-obtained property, whether acquired through conversion or otherwise, may be considered property within the company's "undertaking", and this is attached by the charge.¹⁹⁶

There may be cases where there is an imbalance between the value of the item received and the property used for payment. For instance, let us adjust the example above so that the contractual payment was by instalments, and R is appointed before the final instalment is due. The attached money R uses for the final instalment, which transfers ownership, is of far lower value than the property received. Before payment the chargeholder only had an attached interest in the money, now it may have such an interest in a much more valuable item. This may be perceived as an unfair windfall. However, earlier payments were used to contribute to the overall price of the machinery and these moneys might otherwise have been in the estate and remained attachable by the charge. Therefore, the chargeholder seems entitled to the benefit.

In *Ross*, the court's fall-back position¹⁹⁷ was that the goods in question were re-acquired by the chargor, through the receiver, on credit terms and the effect regarding attachment was the same as if immediate payment had been made.¹⁹⁸ The liquidator had accepted that the charge would attach to goods obtained by the company through "purchase or conversion", carried out by the receiver, where already attached property was used as payment for the "new" goods. But what is the connection where new property is acquired by the receiver in return for incurring a monetary obligation (through the receipt of credit or other borrowing)? The obligation can be secured on attached property, in which case there is an obvious relationship between existing attached property (its value diminished through encumbrance) and newly-acquired property. This supports the attachment of "new" property.¹⁹⁹ However, even where

¹⁹⁵ *Palmer's Company Insolvency*, para 208, suggests that because *Ross* involved a receiver using his powers to continue the company's business, and he was acting in the normal course of business, it was unnecessary to consider whether the charge attached the acquired stock.

¹⁹⁶ *Greene and Fletcher: Receivership*, para 2.37, note the argument that the undertaking "includes the right to acquired property". See 92ff for more details regarding the meaning of undertaking.

¹⁹⁷ If they were wrong about all "acquirenda" being available to the receiver.

¹⁹⁸ At 162.

¹⁹⁹ The creditor might be able to use the receivership creditor provisions mentioned below to rank ahead of the chargeholder. *Greene and Fletcher: Receivership*, para 3.08, note that a receiver granting

existing property is not used to secure the obligation, attachment to the new property can be warranted. As Sellar notes, a receiver who is personally liable under a contract is entitled to be indemnified from the property he was appointed over,²⁰⁰ and this, in a sense, means that the value of existing attached property available to satisfy a chargeholder is reduced and that lost value is replaced by the new property obtained through borrowing.²⁰¹ The 1986 Act, s 60 also makes distribution of proceeds to the chargeholder subject to, *inter alia*, “creditors in respect of all liabilities, charges and expenses incurred by or on behalf of the receiver”,²⁰² and, next, the receiver’s “liabilities, expenses, remuneration, and any indemnity to which he is entitled out of the property...”.²⁰³ The fact that a chargeholder will potentially suffer due to the debts incurred by a receiver justifies attachment of the charge to property acquired in return for the creation of those debts.

(c) Extinction

Another type of post-attachment property is that which causes the “extinction” of attached property. This is similar to conversion, insofar as “new” property is being received in place of existing attached property. But with conversion one party transfers property to another and receives property from that second party in exchange; there is mutual transfer, from A Ltd to C Ltd and from C Ltd to A Ltd. With extinction, however, there is only transfer from C Ltd to A Ltd, but this extinguishes A Ltd’s personal right to the property. For instance, A Ltd has a contractual right to receive ownership of goods from C Ltd. However, before C Ltd transfers ownership to A Ltd, B Bank appoints a receiver, R, to A Ltd. As the contractual right is attached by the charge, and is extinguished upon C Ltd transferring ownership of the goods after attachment, the charge should be deemed to attach to the goods from when they enter the patrimony of A Ltd. They have indirectly replaced the property that was already attached. Again, penalising the chargeholder would seem inappropriate here.

security is unusual, except where there is a hive down and the receiver is procuring the creation of a charge by a subsidiary.

²⁰⁰ See now 1986 Act, s 57(3).

²⁰¹ Sellar (n 176) at 243. An alternative to the receiver being personally liable would be if the company had agreed to be liable in relation to any contracts entered into by the receiver.

²⁰² s 60(1)(c).

²⁰³ s 60(1)(d).

It might be thought that property which returns to the company, or an equivalent payment made to the company, following a successful challenge of a gratuitous alienation, would be covered by the attached charge because the property replaces extinguished property (a right to challenge). However, claim rights for the reduction (or equivalent) of a gratuitous alienation, unfair preference or other challengeable transaction, are not the chargor's property.²⁰⁴ Rather, these are statutory rights of the liquidator or administrator or of any creditor of the chargor, and are therefore not attachable.²⁰⁵ And equivalent rights at common law are rights held by creditors.²⁰⁶ Since s 176ZB(2) of the 1986 Act was introduced (by the 2015 Act, s 119), there is also legislative authority that the proceeds of statutory claims by an administrator or liquidator (including for unfair preferences and gratuitous alienations) "are not part of a company's net property", which is the property secured by a floating charge. As specified in the Explanatory Notes to s 119, this was merely a codification of (English) case law. For example, in *Re Yagerphone*²⁰⁷ money recovered by joint liquidators from a creditor, who had received it on the basis of an alleged fraudulent preference, was not attached by a floating charge, as the money was not the company's property or a contingent interest of the company when the charge crystallised. Instead, the right to recover was deemed to have been conferred for the benefit of the general body of creditors.²⁰⁸

Prior to the recent legislative change, St Clair and Drummond Young asserted that the reasoning in *Re Yagerphone* was challengeable in Scots law.²⁰⁹ Their view was that the rights relating to gratuitous alienations and fraudulent preferences were assets of the company and, by implication, attachable by a floating charge. They considered the relevant statutory actions were merely "machineries" to vindicate the company's rights and that reduction of voidable transactions is not completely without retrospective effect.²¹⁰ The foregoing perspective has

²⁰⁴ The English position regarding challengeable transactions and the remedies available is somewhat different – see Goode, *Principles of Corporate Insolvency*, para 13-142.

²⁰⁵ On this point, similar considerations apply in English law, see Goode, *Principles of Corporate Insolvency*, para 13-142. As noted at this paragraph, there are important implications in relation to issues such as set-off.

²⁰⁶ See St Clair and Drummond Young, *Corporate Insolvency*, paras 10-02ff and the authorities cited there. More broadly, see WW McBryde, *Bankruptcy*, 2nd edn (1995), ch 12.

²⁰⁷ N 182.

²⁰⁸ See also *Re Oasis Merchandising Ltd* [1998] Ch 170.

²⁰⁹ Para 6-14. This is also argued in DP Sellar, "Floating Charges and Fraudulent Preferences" 1983 SLT (News) 253.

²¹⁰ Para 6-14. See also Sellar (n 209) who refers to retroactive consequences of reduction and suggests that effect should be given to the rights of parties at the date of preference, thus allowing the property to be attached by the charge. And see SLC, *Consultative Memorandum No 72: Floating Charges and Receivers* (1986), paras 2.26ff.

been overtaken by the new legislative provisions; however, it could still represent the position for *creditors'* statutory and common law rights of challenge. But the likelihood is that it does not. It seems artificial to state that rights that are stipulated to be those of a creditor are actually the company's. And the fact that liquidation (for statutory challenges) or insolvency (for challenges at common law)²¹¹ is necessary to trigger the creditors' rights suggests there is also collectivity amongst creditors as to property obtained through the exercise of those rights. This is supported by the fact that an individual creditor does not directly receive the benefit of a successful challenge but, rather, property is returned or payment made to the debtor, which is in a state of liquidation and/or insolvency. In situations like these, the default position is equal treatment to all creditors and this is also indicated here by the claims potentially being available to any creditor, as well as a liquidator or administrator. Indeed, St Clair and Drummond Young acknowledge that the rights were intended to benefit the creditors collectively,²¹² which appears at odds with the view that they can be attached by the charge of one creditor.

Interestingly, *Ross* featured a situation relating to rights of challenge: the receiver had convinced a creditor of the company to return goods, allegedly on the basis that the creditor's acquisition of them would have been challengeable as a fraudulent preference in liquidation. Ultimately there was no agreement or decision on whether there had been a fraudulent preference.²¹³ But the circumstances represent a plausible scenario in which a creditor, under threat of its transaction being challenged, retransfers property (or makes equivalent payment) to the company after attachment of a charge. If the right of challenge is not attachable by the charge then such property should not be either, unless there is some other direct relationship with property that is attached.²¹⁴ Therefore, without such relationship, a receiver should not have power or control of property recovered in this way and proceeds from the property cannot be distributed by the receiver to the chargeholder or others. (It is a separate question whether a third party can validly acquire from the receiver; a person dealing with the receiver in good

²¹¹ McBryde, *Bankruptcy* (n 206), paras 12.32f, suggests that one of the requirements for a successful challenge at common law is that at the time of the transaction the debtor must have been absolutely insolvent or about to become so. Of course, insolvency by itself does not cause attachment of a charge. So it would technically be possible for a creditor to successfully challenge a transaction and for property to be received by the company, only for a floating charge granted by that company to subsequently attach.

²¹² St Clair and Drummond Young, *Corporate Insolvency*, para 6-14.

²¹³ See 159f per LP Emslie.

²¹⁴ Such as if payment is made for returned property using eg attached property, see discussion above.

faith and for value does not need to enquire whether the receiver is acting within his powers (1986 Act, s 55(4)).²¹⁵

The position for challengeable transactions may differ from the position for other voidable transactions for which the company itself has the right to reduce a transfer. In these cases, a floating charge can attach the right to reduce and ought to also attach the returning property, if the reduction takes place. The position for voidable transactions, including challengeable transactions, also differs from where a “transferee” believes it has acquired property from the chargor but the transfer is void. In this case, the property has remained in the chargor’s patrimony (assuming it has title) and is therefore liable to attachment in the normal way.²¹⁶

(d) Property from Services Rendered

A further possibility regarding post-attachment property is “property from services rendered”. A Ltd may have a valuable contract with C Ltd which requires A Ltd to carry out some additional work for payment. R, upon appointment to A Ltd by B Bank, may decide to carry out such work to receive the money. If these services are rendered, will B Bank’s floating charge attach to the money received? There seems to be a more fragile argument for attachment here. There is less proximity between attached property and the property received. Nevertheless, A Ltd’s conditional contractual rights against C Ltd are attached by the charge, and property enters the patrimony of A Ltd in return for the work. The work done will purify certain conditions of the contractual rights and then particular contractual rights will be extinguished once payment is made. Therefore, there is again some form of exchange of the attached property for newly received property, which may justify attachment. This can be contrasted with a situation in which new contracts are entered into by a receiver (or equivalent), which would create new property rights perhaps unconnected to existing attached property. The contention that a charge attaches to such new property is correspondingly weaker. It is paradoxical if a receiver, who only has powers in relation to attached party, has control over new property which is not attached. In reality, the “new” property will be

²¹⁵ There are related provisions for administration (1986 Act, Sch B1, para 59(3)). And see also, for liquidation, 1986 Act, s 185(1)(b) applying 2016 Act, s 109(10).

²¹⁶ This is in line with the English position. See Goode, *Principles of Corporate Insolvency*, para 13-141.

dependent upon, for example, payment being made using attached moneys, or through services requiring the use of attached goods or machinery. And even if this is not so, liabilities and indemnities involving a receiver are given a ranking relationship against attached property, as already noted. It is therefore difficult for there to be many instances in which acquirenda in this category will not be attached upon their acquisition.

(e) Gifts

There are other transactions which result in acquirenda. In the unlikely event that property was gifted to the company following attachment,²¹⁷ it seems hard to justify such property being attached. Bennett rightly attacks the argument of the court in *Ross* because it appears to imply that gifted property would be attached.²¹⁸ Sellar also criticises this possibility.²¹⁹ A post-attachment gift should only be attached if it is received in fulfilment of a binding promise pre-dating attachment, which is itself attached. In other cases, there is no connection between property already attached and the newly-gifted property and the latter should therefore benefit the company or its creditors as a whole.

(f) Original Acquisition

Another acquirenda possibility arises where property is obtained through original acquisition. For this, it is probably most simple and appropriate to fit attached property into the relevant rules of original acquisition of ownership. As an example, a new item of property could be created, on behalf of a company after attachment, through specification from two items of property using a manufacturing process. The default ownership position would be that the manufacturer would own the property if the thing could not be returned to its original materials, while if it could be so returned, then the owner(s) of the constituent property items would remain owner(s).²²⁰ In the latter case, the chargor would therefore continue to be owner of any constituent items it owned before specification and this property would be attached. More problematic is where the owner of the new thing is the manufacturer. Again though,

²¹⁷ This could be an *ex gratia* payment, ie where there was only a moral rather than a legal obligation to pay.

²¹⁸ *Palmer's Company Insolvency*, para 207.

²¹⁹ Sellar (n 176) at 243.

²²⁰ See Reid, *Property*, paras 559ff.

using the pre-attachment ownership position provides an answer. If the property was owned by the chargor before specification and the chargor is the manufacturer, the new property ought to also be attached. By contrast, if the property had belonged to the chargor and another party was the manufacturer, and became owner, then the charge would not extend to that property. This would be true for rights in security generally but is even more applicable to the floating charge because of its patrimonial limitations.²²¹ The charge would, however, attach to any claim of the chargor for compensation from the manufacturer.²²²

If, in the example above, accession rather than specification took place, then the rules on ownership of acceded property should apply. The owner of the principal becomes the owner of the accessory as well.²²³ Consequently, if the principal belonged to the chargor and was attached property, the accessory could subsequently also be attached. But if neither item or only the accessory was attached, then the charge would not attach to the property after accession. (However, there could be attachment to a compensation claim, if the chargor owned the accessory and another owned the principal and had brought about accession without the chargor's permission.)²²⁴ These scenarios represent either a potential windfall or loss for the chargeholder. However, any alternative suffers from significant complications. For example, if a charge attached an item that then acceded to a principal and thereafter attached a corresponding proportion of the principal, this would require calculations based on the respective values of the principal and accessory, and might raise questions as to ranking priority against parties with security over the (principal) property.

(g) Administration and Liquidation

While a receiver has the power to carry on the company's business, to the extent covered by the charge,²²⁵ a liquidator can only continue business so far as necessary for the company's "beneficial winding up".²²⁶ Thus, he will not ordinarily have the ability to exchange attached property for other items, or to carry out services for payment, except to the extent that these are undertaken for the company's winding up. A liquidator would though be entitled to

²²¹ See chapter 6.

²²² See Reid, *Property*, paras 561f for the claim position.

²²³ Ibid, paras 570 and 574.

²²⁴ Ibid, para 577.

²²⁵ 1986 Act, ss 55 and Sch 2, para 14.

²²⁶ Ibid, ss 165 and 167, Sch 4, para 5.

perform a contract if it was profitable, as this would benefit the winding up and the company's creditors. A company can also generally receive property, even though it is in liquidation, including in situations where property is transferred to it to fulfil a personal obligation to transfer. And a liquidator is empowered to do certain things which can lead to the acquisition of new property, such as raising money on the security of the company's property.²²⁷ In English law, there is an apparent difference between assets received by the company after the beginning of winding up which are not the result of the liquidator's activities and those which the liquidator acquires through contractual performance or due to proceedings for fraudulent or wrongful trading and similar actions.²²⁸ The former can be caught by an "after-acquired property clause" in a charge, while the latter are statutorily recovered assets which the liquidator holds for the general body of creditors.²²⁹ As regards the former, the suggested Scots law position outlined above appears narrower than English law, as the contractual emphasis of English law seems not to require a connection between attached property and newly-obtained property. With reference to the latter, it could be that Scots law accords with English law regarding property obtained through contractual performance of the liquidator. The charge may have attached to contractual rights but if these are conditional upon performance by the liquidator, a party acting on behalf of all creditors, then it seems logical that all creditors ought to benefit from any property acquired as a result of this. The position is, of course, different where *attached* property is transferred by the liquidator in return for other property.

An administrator will, of course, be expected to carry on the company's business and can dispose of charged property and acquire new property.²³⁰ The floating charge will no longer cover property disposed of by the administrator but will secure the "acquired property"²³¹ that replaces it.²³² However, the vast majority of relevant transactions will take place without the charge having attached. Therefore, although it is possible for all of the above types of property acquisition to occur after attachment within administration, the usual position is that the

²²⁷ Ibid, ss 165 and 167, Sch 4, para 10. And see St Clair and Drummond Young, *Corporate Insolvency*, para 4-52.

²²⁸ Goode, *Principles of Corporate Insolvency*, paras 6-01 and 6-06. And see also paras 13-140ff.

²²⁹ Ibid.

²³⁰ 1986 Act, Sch B1, para 70.

²³¹ This is defined as "property of the company which directly or indirectly represents the property disposed of": *ibid*, para 70(3).

²³² *Ibid*, para 70(2). This provision seems unnecessary for unattached charges as this is already how the floating charge operates. Even without such provision, the administrator, as representative of the company, would be able to transfer charged property unencumbered and acquired property would be charged in its place.

property obtained will not be *acquirenda* in the post-attachment sense. Where property is acquired in administration after attachment, the same logic regarding liquidation above will apply. This includes the fact that an administrator acts on behalf of all creditors and, therefore, if his performance is necessary to acquire property, and this leads to the purification of attached contractual rights, then there is a powerful case for the charge not attaching to the new property. But, again, the position will be otherwise if the administrator's actions involve transferring attached property in return for "new" property.

(h) Transferred Property

An important point, although one which is rarely commented upon, is that even though a floating charge attaches to property as if it were a fixed security, it does not continue to affect that property if the property is transferred to another party by the receiver, administrator or liquidator. A transferee, in such a situation, is deemed to acquire the property free of the floating charge.²³³ Despite there being no specific authority on the point, this general view is supported by the fact that a chargeholder depends on a liquidator, receiver or administrator for enforcement. As will be discussed in chapter 6, the rights of these parties are apparently limited to the property of the chargor. This suggests that, at least in practical terms, a floating charge cannot be enforced against a third party that has validly obtained attached property. Consequently, the floating charge seems to provide a right to be satisfied from attached property in the chargor's patrimony, rather than from the property regardless of who owns it.

Assuming that a floating charge does not affect property transferred by a liquidator or equivalent, it should conversely attach to any property obtained in exchange for the "old" property, from the moment the "new" property enters into the chargor's patrimony. The importance of property being within the chargor's patrimony, for the charge to affect it, suggests that attachment to new property will not apply retroactively to the date when the old property was attached. This would mean that attachment to the new property is subject to any existing security rights or other real rights, even if created by the previous owner between the date of the charge's attachment and the property being transferred to the chargor. As noted

²³³ But see *Halliday's Conveyancing*, vol 1, para 2-128, where it is suggested that a liquidator should gain the chargeholder's consent when selling attached property.

elsewhere,²³⁴ the ranking rules seem to limit the charge's ranking to the property in the chargor's patrimony at attachment and affect only securities granted by the chargor. It is, of course, possible to have statutory exceptions to this, such as where an administrator disposes of charged property (before attachment) and acquires new property in exchange.²³⁵ Yet it can be argued that even in those circumstances a chargor with a negative pledge would only have priority against chargor-granted securities (fixed and floating).

(2) Double Attachment

(a) Separate Attachment Events

It is also suggested in *Ross* (obiter) that there can be double attachment of a floating charge: in receivership and again in liquidation. The court considered that the imperative "shall", used in the liquidation provision to describe the charge's attachment upon winding up,²³⁶ meant attachment occurred irrespective of whether the charge had earlier attached upon the appointment of a receiver.²³⁷ As well as that literal statutory interpretation point, they believed that the policy of the Act gave the chargeholder the opportunity to protect its interests using receivership, rather than having to wind up the company. If attachment in receivership meant the charge would not attach (again) in the liquidation, the court believed the chargeholder might be discouraged from appointing a receiver and would instead push the company into liquidation. This is perhaps unlikely given the priority a receiver has over a liquidator and because receivership offers a chargeholder far more control than a liquidator.

Commentators have criticised the notion of double attachment on both formalist and consequentialist grounds. Bennett, for example, suggests that attachment cannot be repeated as the 1985 Act, s 463(3), provides that nothing in s 463 derogates from the provisions of ss 53(7) and 54(6).²³⁸ Sellar makes a similar argument (regarding the antecedent legislative provisions), suggesting that attachment upon liquidation is subject to attachment upon

²³⁴ 41ff.

²³⁵ As it is stated that the chargeholder "shall have the same priority in respect of acquired property as he had in respect of the property disposed of": 1986 Act, Sch B1, para 70(2).

²³⁶ Under the then-applicable 1972 Act, s 1(2).

²³⁷ Per LP Emslie at 162f.

²³⁸ *Palmer's Company Insolvency*, para 207. And see *Palmer's Company Law* (n 191), paras 13.235ff.

receivership.²³⁹ It is notable, however, that, even if this is the case, s 463(3) does not refer to attachment in administration. Therefore, the provision would not stop a charge attaching in administration and then again, subsequently, in liquidation.²⁴⁰ St Clair and Drummond Young have suggested that changes in the applicable legislative provisions for attachment (upon different events) mean that “it is not possible to say whether in future a court would stick to the concept of ‘double attachment’”.²⁴¹ Indeed, one potentially significant change (from the 1972 Act) is that “shall” was not included in the (currently applicable) 1985 Act provisions for attachment in liquidation.²⁴² Meanwhile, Sellar has noted the potential, unintended, second ranking of preferential creditors upon a second attachment.²⁴³ This criticism could also be applicable in an administration and liquidation double attachment context.

In addition to these points, it is difficult to see, conceptually, how a floating charge can attach if it has already done so. Upon attachment the nature of the charge transforms and it attaches to property as if it were a fixed security. It is not possible in Scots law for a floating charge to be both floating and fixed at the same time.²⁴⁴ Attachment has either occurred for all charged property or it has not; it is an absolute event for property covered by the charge. Sellar similarly contends that double attachment is at odds with the nature of the floating charge and the “fundamental change” that occurs upon attachment.²⁴⁵ It could be argued that a second attachment event causes the charge to attach only to property obtained between the attachment events which is not already attached through conversion, or otherwise. A major objection to this is that it requires the floating charge to residually float (in addition to its attachment to property), when the clear statutory effect upon any attachment event is for it to attach to all of the property charged.

²³⁹ Sellar (n 176) at 244.

²⁴⁰ Even if such double attachment is unlikely given that attachment in administration will only occur in limited circumstances.

²⁴¹ St Clair and Drummond Young, *Corporate Insolvency*, para 6-09.

²⁴² 1985 Act, s 463(1)-(2).

²⁴³ Sellar (n 176) at 244. For the current relevant legislative provisions, see 1986 Act, ss 59 and 175.

²⁴⁴ See Bennett, “Companies”, para 166, who also notes that it is not possible for a Scots law security to shift between being floating and fixed.

²⁴⁵ Sellar (n 176) at 244. Sellar prefers what he refers to as the “previously unchallenged” pre-Ross view that only one attachment is possible.

(b) “Re-floating” and Attachment

What is possible, at least in certain limited circumstances, is that the floating charge can “re-float”. Consequently, the re-attachment of a floating charge can occur. The 1986 Act, s 62(6), provides that if a new receiver is not appointed within one month after the previous one is removed, or otherwise stops acting as receiver, then the charge will cease to attach and will again subsist as a floating charge.²⁴⁶ This is, however, an exception. In the absence of express statutory authority allowing for re-floating, it is presumed that a charge which attaches and is then enforced does not re-float (allowing for further attachment) once the enforcement process is complete. A chargeholder does not have the general ability to decide to attach and unattach a floating charge at its leisure, as this would be problematic for other creditors and for the running of the chargor’s business. Although a chargeholder would have some limited power to do this through removing a receiver, it must follow the statutory process for doing so, and the receiver has entitlement to payment using attached property.²⁴⁷

The chargeholder has less power over liquidation and administration. However, there is scope to argue that a charge can re-float after attachment in a liquidation.²⁴⁸ This will not be the case if the liquidation is successfully concluded. But once a liquidation is underway, it can be stopped. The court may, at any time after a winding up order, sist proceedings completely or for a limited period.²⁴⁹ In such an instance, the chargeholder would lose the mechanism by which its attached charge was to be enforced. As such, does the charge re-float? There is no easy answer to this. In practical terms, continued attachment here might make little difference, as the charge cannot be enforced outside one of the recognised enforcement mechanisms. However, it will give a ranking priority if and when the charge is enforced.²⁵⁰ In any event, if the liquidation is stopped, it may be because the company is able to pay its debts and can

²⁴⁶ And see *Greene and Fletcher: Receivership*, paras 11.12, who suggest that if a charge is not satisfied and the chargeholder later becomes aware of further assets, then it may reappoint a receiver and cause the charge to attach.

²⁴⁷ 1986 Act, s 62(4).

²⁴⁸ The position for administration is more straightforward as attachment will only occur when distributions are taking place.

²⁴⁹ 1986 Act, ss 112(1) and 147(1). See St Clair and Drummond Young, *Corporate Insolvency*, para 4-114, who note that a sist will not normally be granted without “firm and acceptable proposals for satisfying all creditors” and “consent from, or arrangements binding, the liquidator and all members”. And see *McGruther v James Scott Ltd* 2004 SC 514 for a Scottish case in which the sisting of proceedings was granted.

²⁵⁰ Until that happens, there is a danger that attached property could be transferred but property received in return would surely be caught in its place.

therefore satisfy the debt due to the chargeholder, in which case the issue of re-floating will probably not arise.

It is generally accepted that de-crystallisation (re-floatation) is possible in English law.²⁵¹ This is explainable by virtue of the contractual elements of the English floating charge. The parties can, for example, incorporate a clause in the charge agreement allowing the charge to de-crystallise upon notice or the happening of an event.²⁵² The effect of de-crystallisation is more uncertain; is a new charge created and therefore requires registration (which impacts upon ranking priority dates) or is the charge the same as the crystallised one?²⁵³ In Scots law, in the limited circumstances in which re-floating and re-attachment is possible, it seems that the charge should be considered the same one, as there is nothing in the legislative provisions to suggest otherwise. And a new charge can only be created through compliance with the statutory creation requirements.

If, however, a charge re-floats and then re-attaches, the second attachment should be the relevant point for ranking and other purposes (subject to the instances when the charge ranks from its creation). Attachment and the relevant enforcement mechanism should be viewed as a package, with the receiver or equivalent using the attachment date as a relevant point for its dealings relating to the charge. If the charge returns to a floating state and ranks from the date of an earlier attachment, it may be misleading to other parties dealing with the chargor and could also have a chilling effect on transactions between such parties and the chargor.

²⁵¹ See eg Goode, *Legal Problems*, paras 4-57 and 4-62ff.

²⁵² Ibid, para 4-62.

²⁵³ Ibid, para 4-63. Different theories regarding the nature of the charge seem to lead to different outcomes here.

CHAPTER 4

THE PROPERTY ATTACHED

A.	LIMITS	75
B.	“PROPERTY AND UNDERTAKING”: PAST AND PRESENT	78
(1)	Legislative Usage in Scots Law	78
(2)	Why Was “Property and Undertaking” Used in the 1961 Act?	81
(3)	The History of “Property and Undertaking”	83
C.	THE MEANING OF “PROPERTY... COMPRISED IN [THE COMPANY’S] PROPERTY AND UNDERTAKING”	91
(1)	Two Uses of “Property”	91
(2)	“Property and Undertaking”	92

A. LIMITS

There are two elements which determine the property attached by a floating charge in Scots law. Firstly, there is a legislative limit. The floating charge legislation identifies the full range of property over which a floating charge can be granted and subsequently attach. Attachment is chargor-relational and time-dependent; its application is reliant upon the chargor having a particular relationship to property at a certain point in time (ie when attachment occurs). Secondly, in each particular case, the grantor must determine which property, within the set limit, it wishes to create the charge over and thus make potentially attachable. The 1985 Act, s 462(1), gives the power to an incorporated company to create a floating charge “over all or any part of the property (including uncalled capital) which may from time to time be comprised in its property and undertaking.” A floating charge can therefore be created over any item(s) of property in a company’s property and undertaking, with the maximum legislative limit being all such property at a given time. The liquidation attachment provision ties attachment directly to property “comprised in the company’s property and undertaking or, as the case may be, in part of that property and undertaking...” at the commencement of liquidation.²⁵⁴ The provisions for attachment in receivership and administration limit

²⁵⁴ 1985 Act, s 463(1).

attachment to property in the company's property and undertaking indirectly by referring to "property... subject to the charge".²⁵⁵

One additional point is that, under the current regime, the "validity" of a company's acts "shall not be called into question on the ground of lack of capacity by reason of anything in the company's constitution".²⁵⁶ It was previously possible for the grant of a floating charge to be outside a company's objects and therefore void.²⁵⁷ The removal of ultra vires constraints does not, however, impact upon the inability of a Scottish company to grant a floating charge (over property in Scotland) at common law, as determined in *Ballachulish*²⁵⁸ and *Carse*.²⁵⁹ That is because the underlying law of security rights, applicable to Scottish-registered companies, proscribes the creation of floating charges, irrespective of the content of a company's constitution.

The creation and attachment of a floating charge correspond to what is allowable by statute. Only property which falls within both the legislative limit and the terms of the charge instrument will be attachable by a floating charge. Any property that is attached must therefore be located in the inner area in *Figure 1*.²⁶⁰ Attempts to charge property not contained in the property and undertaking of the company will be invalid and, likewise, property in the property and undertaking but not charged in the instrument will not be covered. As well as property presently owned by the chargor, the charge instrument will typically seek to charge future property, either expressly or impliedly. The company's property and undertaking extends to such property but, of course, the property only becomes charged once the chargor acquires it. At that point, it will automatically fall under the charge's ambit. Understandably, floating charges are most commonly granted in line with the legislative maximum limit – over the whole (or all of) the property in the chargor's property and undertaking²⁶¹ – and therefore,

²⁵⁵ For receivership, "the property then subject to the charge" (1986 Act, s 53(7) and 54(6)); and see s 51(1). And for administration, "the property which is subject to the charge" (1986 Act, Sch B1, para 115(1B) and (3)).

²⁵⁶ 2006 Act, s 39(1). This is so even if the company's objects are expressly limited. See also s 31(1).

²⁵⁷ See Bennett, "Companies", para 48, for details regarding objects under the previous law, and what was done to circumvent the restrictions.

²⁵⁸ N 1.

²⁵⁹ N 1. For criticism of the decision in *Carse*, see Lord Rodger (n 8) at 423.

²⁶⁰ The diagram could be applicable where, for example, a company charges all of its stock-in-trade or debts due from customers.

²⁶¹ See eg DJ Cusine (ed), *Green's Practice Styles* (Looseleaf) (1995-), B01-02; E03-22; *Greene and Fletcher: Receivership*, 239.

in most cases, there will be complete overlap between the two limits, unlike in *Figure 1*. However, limited assets floating charges do exist.²⁶²

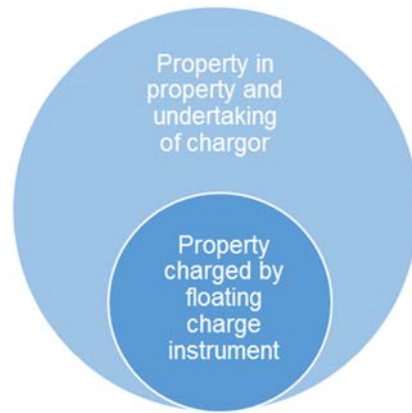

Figure 1

For voluntary real security rights there is a legal limit which determines the property over which the security may be granted. This usually means that a party can only grant a particular form of security corresponding to specific property which that party owns. By contrast, the floating charge can be granted over all property, or over a collection of property encompassing different types. For rights in security more widely, the specificity principle usually requires that the secured property must be identified. The necessary steps for this, and the varying ways in which the publicity principle is met for different securities, mean it is generally not possible for the same security to be granted over multiple pieces of property. With the floating charge there is a weak form of specificity. Individual items of property do not need to be identified: categorisation of property (as part of all of the property of the chargor, or as eg intellectual property or book debts) is sufficient. This also facilitates the granting of the security over future property.

The floating charge is also less compliant with the publicity principle than other security rights. As already noted, creation of a charge was formerly upon execution of the floating

²⁶² It may be that more floating charges than before the 2002 Act are being granted over limited assets of a chargor, to allow for the appointment of a receiver despite the wider circumscription of administrative receivership, but there is scant information to verify this.

charge instrument but now seems to be upon the instrument's delivery.²⁶³ This represents a positive advance but it is still essentially a private act.²⁶⁴ The floating charge must thereafter be registered in the charges register within a specified time period to be fully effective.²⁶⁵ This involves registration against a juristic person, with specification as to property covered, rather than publicity by immediate reference to specific property affected. The stage at which the floating charge becomes a security with real effect is attachment, which depends upon an event affecting the person of the debtor, through the appointment of a receiver, commencement of liquidation, or in certain circumstances during administration. As noted in chapter 3, there are publicity problems with respect to property attached by the charge.

B. "PROPERTY AND UNDERTAKING": PAST AND PRESENT

The term "property and undertaking" of the company has proved to be particularly controversial in Scots law. The interpretation of this wording was the central focus in *Sharp*, which is discussed in chapter 7. Due to the term's significance in determining property attached by the floating charge, its usage and background will be examined here.

(1) Legislative Usage in Scots Law

The term was included within the legislation introducing the floating charge into Scots law. The 1961 Act, s 1(1), provided that it was competent for an incorporated company to create a floating charge "over all or any of the property, heritable and moveable, which may from time to time be comprised in its property and undertaking". The next sub-section (s 1(2)) specified that a floating charge would not affect property:

²⁶³ At least for registration purposes: see n 14; and H Patrick, "Charges Changing" (2013) 58(2) JLSS 20.

²⁶⁴ It differs from eg the requirement of delivery of corporeal moveables to create a pledge. Delivery to, and possession by, the pledgee of the *property* pledged, gives publicity to those who may wish to obtain an interest in the *property*. By contrast, with the floating charge, it is the instrument that is delivered, not the property secured.

²⁶⁵ See text accompanying n 13.

which ceases prior to the commencement of the winding up of the company to be comprised in, and remains outwith, the company's property and undertaking, but shall on the commencement of the winding up of the company... attach to the property then comprised in the company's property and undertaking not being excepted property...²⁶⁶

Consequently, from the outset, both the creation of the floating charge, and its attachment, have been connected to property in the chargor's "property and undertaking". If property was outside the company's property and undertaking then it was automatically excluded, but could also be non-attachable if it was "excepted property", ie particular property consensually excluded from the created charge's ambit.²⁶⁷

The 1961 Act apparently caused practical difficulties as regards the charging of specific property.²⁶⁸ And the SLC noted that s 2²⁶⁹ had been criticised by some as making it "possible to create a floating charge over only the whole of the undertaking of the company, or over the undertaking other than specified excepted assets."²⁷⁰ This implies a belief that the undertaking incorporated all of the company's assets. The SLC contrasted the position with English law, in which a floating charge could "be created over any part of the assets of a company". The "more flexible" English approach was considered preferable and therefore recommended,²⁷¹ and was subsequently introduced in the 1972 Act.

The 1972 Act allowed (at s 1(1)) for the creation of a floating charge "over all or any part of the property (including uncalled capital) which may from time to time be comprised in its property and undertaking." A few differences with the 1961 Act are notable: the insertion of a reference to "part" of the property, to address the issue noted above; and the removal of "heritable and moveable", and its replacement with the express inclusion of uncalled capital.

²⁶⁶ But this attachment was subject to the rights of various specified parties. See also chapter 2 for discussion of this provision.

²⁶⁷ See 1961 Act, s 1(3).

²⁶⁸ SLC, *1961 Act Report*, para 13. And there were doubts as to the chargeability of uncalled capital.

²⁶⁹ Which referred to the creation of a floating charge with reference to an instrument of charge as nearly as practicable to the form of the Act's First Schedule.

²⁷⁰ SLC, *1961 Act Report*, para 13.

²⁷¹ *Ibid.*

The reference to “property and undertaking” in the 1972 Act attachment provision was also slightly altered. The mention of when a floating charge would *not* affect property was removed, as was the reference to “excepted property”. Instead, it was stated that on attachment a floating charge attached “to the property then comprised in the company’s property and undertaking or, as the case may be, in part of that property and undertaking”, but again subject to the rights of certain parties.²⁷² The reference to “part of that property and undertaking” here suggests that “property and undertaking” ought to be considered as one contiguous concept rather than as separate terms.

The 1985 Act, s 462(1), repeats the wording of the 1972 Act regarding “property and undertaking” in the creation context. And s 463(1) does likewise for property and undertaking for attachment. So, although there have been some changes in the relevant legislative provisions since the floating charge was introduced, these are apparently immaterial regarding the meaning of “property and undertaking”.²⁷³

“Property” is a defined term in the 1986 Act but not in the 1985 Act. In the former, property “includes money, goods, things in action, land and every description of property wherever situated and also obligations and every description of interest, whether present or future or vested or contingent, arising out of, or incidental to, property”.²⁷⁴ This is an English law-focused definition but it is non-exclusive and gives a meaning of property based upon a wide variety of things. It also seems to extend to the notion of property as both a “thing” and as “belonging” to a party (see further below). Despite the absence of a definition in the 1985 Act, there should be a presumption of uniformity between the two pieces of legislation, given the intertwining nature of various legislative provisions and because the terminology of “property and undertaking” in the 1986 Act was a reflection of the 1985 Act.²⁷⁵

²⁷² 1972 Act, s 1(2).

²⁷³ The terms “property and undertaking” (s 859D(2)(b)) and “property or undertaking” (ss 859C-859D, 859H-859L, 859O-859P) are also used in the context of the current registration of charges regime in the 2006 Act.

²⁷⁴ 1986 Act, s 436.

²⁷⁵ And all of the provisions for floating charges were previously together in the 1972 Act. The term “property and undertaking” is used at various points within the 1986 Act: ss 51(1), 122(2), 221(7).

Before examining why the terminology was originally chosen, it is interesting to note that “undertaking” is now defined in the companies legislation. The 2006 Act, s 1161(1), states that in the Companies Acts “undertaking” means “(a) a body corporate or partnership, or (b) an unincorporated association carrying on a trade or business, with or without a view to profit”. The “Companies Acts” includes the provisions of the 1985 Act still in force.²⁷⁶ The effect of the definition for current purposes is not obvious and it may be that the 1985 Act provisions were simply overlooked when the new definition was decided upon. There are, of course, other contexts within which “undertaking” is used in a different way, even in the 2006 Act – most notably as a type of promise or agreement.²⁷⁷ The new definition does not expressly apply to the 1986 Act.

(2) Why Was “Property and Undertaking” Used in the 1961 Act?

The *Eighth Report* used the term “undertaking and assets” rather than “property and undertaking”.²⁷⁸ It is clear from LRCS archive correspondence that there was uncertainty about the meaning of the terms. When JH Gibson, the LRCS’s Secretary, was writing to WA Cook, an LRCS member, he queried whether it was necessary to refer to “undertaking” as well as “assets”, as he doubted that the former included anything that was not already covered by the latter.²⁷⁹ He acknowledged, however, that a draftsman might eventually need to decide whether to conform to the terminology of the 1948 Act, s 95(2)(f), which provided the registration requirements for English-registered companies of a floating charge on the “undertaking or property of the company”.²⁸⁰ On the basis of this statutory provision, Gibson also enquired whether there was any real difference between “property” and “assets” and asked if the latter was also to include incorporeal property, such as book debts and goodwill.²⁸¹

²⁷⁶ 2006 Act, s 2(1)(c).

²⁷⁷ See eg ss 583ff. Cf the use of “undertaking” in TFEU Arts 101ff; *Höfner and Elser v Macrotron GmbH* (1991) C-41/90. And see the use of the term in The Transfer of Undertakings (Protection of Employment) Regulations 2006/246.

²⁷⁸ As well as being used in this context, “assets” rather than “property” was used elsewhere within *Eighth Report*, Appendix II. *Bell’s Dictionary*, 72, states that assets “is an English law term (now much used in Scotland)... applied more generally to the estate and effects of every description available for the payment of the debts of a bankrupt or insolvent.”

²⁷⁹ NRS AD61/55 – Note on Draft Appendix II to Report to the Lord Advocate on Remitted Subject No 10, enclosed with copy letter from JH Gibson, Lord Advocate’s Chambers, to WA Cook, Biggart, Lumsden & Co, dated 10 March 1960.

²⁸⁰ *Ibid.*

²⁸¹ *Ibid.* See also chapter 9. And see Scottish Standing Committee, 20 June 1961, cols 45-48, for discussion of goodwill in the context of the Bill that would become the 1961 Act.

In response to Gibson’s letter, Cook specified that “undertaking and assets” was “always used in England” at that time.²⁸² He added that “assets” in isolation, within a sale context, suggested a “break-up” whereas “undertaking and assets” would “clearly cover a sale of the undertaking as a going concern”.²⁸³ The suggestion by Cook appears to be that “assets” alone would be limited to property on an individualised basis, whereas “undertaking” in combination with “assets” would include the business as a whole, and also incorporate individual items. Although Cook expressed a preference for retaining the term “undertaking and assets”, he stated that he “did not feel strongly on this point”, and suggested that if it was Gibson’s preference to delete “undertaking” he should do so.²⁸⁴ However, it was not removed from the *Eighth Report*.

In attempting to imitate English law and practice there appears to have been inadequate consideration of the potential meaning, or lack of meaning, of the terminology in Scots law. This was not addressed during the Bill’s progress through Parliament. When introducing the floating charges Bill in December 1960, Forbes Hendry MP, proposed that “Scottish companies should be enabled to give floating charges over their undertakings and assets in exactly the same way as English companies.”²⁸⁵

Ultimately, the 1961 Act adopted the term “property and undertaking” in the attachment provisions rather than “undertaking and assets” or “property *or* undertaking”.²⁸⁶ The precise difference between “property and undertaking” and “property *or* undertaking” is not clear. But, of course, the former proposes a conjunctive meaning whereas the latter provides for “property” and “undertaking” as alternatives. Whether or not “property” and “undertaking” have aligned meanings will be discussed below.

²⁸² NRS AD61/55 – letter from WA Cook, Biggart, Lumsden & Co, to JH Gibson, Lord Advocate’s Chambers, dated 14 March 1960.

²⁸³ This would perhaps have had more relevance if enforcement was to be by the chargeholder or through a receiver, rather than through a liquidator.

²⁸⁴ N 282.

²⁸⁵ HC Deb, 20 December 1960, vol 632, cols 1118-1120.

²⁸⁶ This latter term was used in the 1961 Act within the context of registration of charges in the new s 106A(1) of the 1948 Act, which was inserted by the Second Schedule. And it has remained the more commonly used term throughout the various iterations of the registration provisions, up to and including the present provisions.

(3) The History of “Property and Undertaking”

As already noted, English authority is of limited assistance in considering the Scots law floating charge. However, given that the terminology of “property and undertaking” was used in the 1961 Act, to reflect both English practice and existing provision within the 1948 Act, it is appropriate to examine the term’s origin and meaning in English law. This will enable us to better appreciate the intended operation and application of the Scottish legislative provisions. Thereafter, it is helpful to analyse how such terminology was used in Scots law prior to the introduction of the floating charge.

(a) English Law

The practice of charging the “undertaking” of companies created under the Companies Acts seems to have derived from legislation and usage for companies and undertakings created by private Acts.²⁸⁷ The Companies Clauses Consolidation Act 1845, s 2, and Lands Clauses Consolidation Act 1845, s 2, define “undertaking” as the “undertaking or works, of whatever nature, which shall by the special Act be authorized to be executed”.²⁸⁸ In *Gardner v London, Chatham, and Dover Railway Company*,²⁸⁹ it was held that the undertaking of a statutory railway company was the going concern created by the relevant Act, which was not to be broken up by virtue of the use of the undertaking as security. The security was considered to affect the “earnings of the undertaking”, rather than its “ingredients”.²⁹⁰ An undertaking, in the context, is a specific unified business or operation provided for by private Act, but which can be one of a number of undertakings given, by private Acts, to a particular company. The company then usually has the power to “mortgage” the undertaking(s).²⁹¹

²⁸⁷ This is referred to in some of the commentary on the origins of the floating charge, see eg RR Pennington, “The Genesis of the Floating Charge” (1960) 23 MLR 630 at 638ff.

²⁸⁸ Before the recognition of the floating charge in England, it was judicially stated that “undertaking”, in the context of a charge by a registered company, was as defined in the Lands Clauses Consolidation Act – *King v Marshall* (1864) 33 Beav 565. And see also the Railway Clauses Consolidation Act 1845, s 2 – “the undertaking’ shall mean the railway and works, of whatever description, by the special Act authorized to be executed.”

²⁸⁹ (1866-67) LR 2 Ch App 201. This case was distinguished in *Re Panama*, as it related to a railway company and undertakings arising from private Acts.

²⁹⁰ Per Cairns LJ at 217.

²⁹¹ See Companies Clauses Consolidation Act 1845, s 38.

The term “undertaking” has been connected with the English floating charge since the latter was first recognised. *Re Panama* concerned a company, incorporated under the Companies Act 1862, which had issued debentures charging its “undertaking”. Counsel for the appellant sought to separate the meaning of property and undertaking by arguing that the latter constituted “enterprise” and could not be held to include property “unless the context require[d] such a construction”.²⁹² It was submitted that all the company sought to charge was its income. However, Giffard LJ held that “undertaking”, in the context, “had reference to all the property of the company, not only which existed at the date of the debenture, but which might afterwards become the property of the company.” He added that the term “necessarily infers that the company will go on, and that the debenture holder could not interfere until either the interest which was due was unpaid, or until the period had arrived for the payment of his principal, and that principal was unpaid.”²⁹³ And that “under these debentures they have a charge upon all property of the company, past and future, by the term ‘undertaking,’ ...”²⁹⁴

Re Panama proved significant for establishing an expansive meaning of undertaking as all present and future property of the company.²⁹⁵ It became increasingly normal for a Companies Act company to issue a debenture charging all of its present and future property or its undertaking, and this was considered to create a floating security.²⁹⁶ As Palmer noted in 1898, the following, common, debenture clause was treated by the courts as such a security: “The company hereby charges with such payments its undertaking, and all its property, present and future, including its uncalled capital.”²⁹⁷ The combination of property *and* undertaking here is notable. Although “undertaking” was an apparently useful shorthand for the creation of a floating charge, such a charge could be created using other words.²⁹⁸ The view of James LJ, in *Florence Land and Public Works Co*²⁹⁹ supports this point:

²⁹² At 320.

²⁹³ At 322.

²⁹⁴ At 323.

²⁹⁵ FB Palmer, *Company Law* (1898), 212f.

²⁹⁶ See Lord Lindley, *A Treatise on the Law of Companies*, 6th edn by WB Lindley (1902), 315ff.

²⁹⁷ Palmer, *Company Law* (n 295), 196. This is repeated in later editions.

²⁹⁸ *Ibid*, 198. See also *Re Yorkshire Woolcombers Association Ltd* [1903] 2 Ch 284 per Romer LJ at 294f; and later editions of Palmer.

²⁹⁹ (1878) 10 Ch D 530.

the words ‘estate, property, and effects’ were in fact exactly equivalent to the word ‘undertaking,’ which we find in the other cases, that is to say, it was to be, so far as the company could make it, a special charge upon the assets of the company, the assets which would be forthcoming at the time when the charge was to be made available.³⁰⁰

In relation to Companies Act companies, Palmer later stated that it was “of the essence” of a floating charge that it was “dormant” up to the point at which “the undertaking charged ceases to be a going concern, or until the person in whose favour the charge is created intervenes”.³⁰¹ Consequently, by the early twentieth century, a charge over a company’s undertaking was understood to mean a security over all of its circulating property, a floating charge, which only became truly active upon the occurrence of certain events.

Around this time, legislation began to use “undertaking” and “property” together in relation to floating charges. The Companies Act 1900, s 14(1)(d), required “a floating charge on the undertaking or property of the company” to be registered within 21 days after the date of the charge’s creation, so as not to be void against the liquidator and creditors of the company. This was, of course, repeated in subsequent legislation and the term “property or undertaking” also came to be used in other legislative contexts involving the floating charge.³⁰² By the time the floating charge was being introduced into Scots law, the relevant piece of legislation using the terminology in English law was the 1948 Act.

As evidenced by the English law reference works published shortly before the floating charge’s arrival in Scots law, the meaning of “undertaking” had changed little over the previous decades. The 1959 edition of *Palmer’s Company Law* referred to “undertaking” in similar terms to earlier editions³⁰³ and noted that although “convenient... as a typical term, it must not be supposed that the word ‘undertaking’ has any magic in it, or that an effective floating charge on the property, both present and future, of a company, cannot be created by other forms of words.”³⁰⁴ Thus, equivalence was still being drawn between a charge on the undertaking and a floating charge over the company’s present and future property. In *Buckley*

³⁰⁰ Ibid at 546 per James LJ.

³⁰¹ Palmer, *Company Law* (n 295), 214.

³⁰² Eg Companies (Consolidation) Act 1908, s 93(1)(f). A registration provision in essentially the same terms was included in the 1948 Act, s 95(2)(f). See also the use of “property or undertaking” and similar wording in eg 1948 Act, ss 100, 104(1), 192, 208(1), 322.

³⁰³ See CM Schmitthoff and TPE Curry, *Palmer’s Company Law*, 20th edn (1959), 374 and 398ff.

³⁰⁴ Ibid, 400.

on the *Companies Acts* a number of cases were used to highlight the fact that a floating charge was produced by debentures on the “undertaking”, “undertaking and property” and “all the estate property and effects” respectively.³⁰⁵ Gower, who was consulted by the LRCS regarding the English law of floating charges,³⁰⁶ stated, in the most contemporary edition of *Principles of Modern Company Law*, that it was possible for a creditor to “obtain an effective security on ‘all the undertakings and assets of the company both present and future’”.³⁰⁷ This was presumably a common debenture clause used to create floating charges. In addition, he noted that a charge on the “undertaking” of a company was a general equivalent of stating the charge was “by way of floating charge” on the present and future property and pointed out that the chargor’s power to deal with its property could include the sale of the whole undertaking to another company in exchange for securities in that company.³⁰⁸

The English authorities were also referred to in commentary on the term “undertaking” shortly after the floating charge’s introduction in Scots law. Gow cited Palmer and *Re Panama* when stating that “undertaking” in the 1961 Act “means all the property of the company not only existing at the time of the creation of the charge but in the interim coming into existence and being the property of the company at the time when the charge attaches or ‘crystallises’”.³⁰⁹ And according to modern English law texts, such as *Charlesworth’s Company Law*,³¹⁰ “undertaking” continues to correspond to all of the company’s present and future property, as specified in *Re Panama*.

(b) “Undertaking” in Scots Law

Given the common company law elements of England and Scotland, “undertaking” was not an entirely new term when used in the Scottish floating charges legislation. Gloag and Irvine identify the increase of companies created by private Acts in the middle of the nineteenth century and the consequent passing of the Companies Clauses Consolidation (Scotland) Act

³⁰⁵ Lord Wrenbury, *Buckley on the Companies Acts*, 13th edn by JB Lindon (1957), 225f.

³⁰⁶ *Eighth Report*, para 3.

³⁰⁷ LCB Gower, *The Principles of Modern Company Law*, 2nd edn (1957), 75.

³⁰⁸ *Ibid*, 390 n 31. Citing *Re Borax Co* [1901] 1 Ch 326 CA.

³⁰⁹ Gow, *Mercantile Law*, 279, n 76. Schmitthoff and Curry, *Palmer’s Company Law* (n 303), 400.

³¹⁰ Girvin et al, *Charlesworth’s Company Law* (n 148), para 25-015, “Thus a floating charge is an equitable charge on some or all of the present and future property of a company, eg the company’s undertaking, ie all its property, present and future.” *Re Panama* is cited in support.

1845 and the Companies Clauses Act 1863.³¹¹ The 1845 Act, s 2, provides that “‘the undertaking’ shall mean the undertaking or works, of whatever nature, which shall by the special Act be authorized to be executed.”³¹² Companies are given the power to mortgage their undertakings by s 40, with a mortgage deed in the prescribed form having the “full effect of an assignation in security duly completed”.³¹³ The intended meaning here is not clear, but it suggests that the undertaking is incorporeal property that is transferred to the mortgagee for security purposes. Yet it is unlikely that the property encompassed by the undertaking is limited to incorporeal property.³¹⁴ The 1845 Act contains a form of mortgage in Schedule C, which caters for the mortgaging of the “undertaking” along with *inter alia* the “estate, right, title, and interest of the company” in the tolls and sums of money arising from the private Act creating the undertaking. The “mortgages” require to be included in a register kept by the company.³¹⁵

Gloag and Irvine also contemplate the effect of a mortgage of a company’s undertaking under the Companies Clauses Acts. In their view, it seems to give the mortgagee a right to “the property comprised in it as it may happen to exist at the time being”.³¹⁶ Despite its designated status as an assignation in security, Gloag and Irvine do not consider the mortgage to “prevent the company from dealing with, or even disposing of, that property in the ordinary course of their business.”³¹⁷ If this is the case, it seems that the effect of the mortgage as a deemed assignation in security is not divestive regarding the mortgagor’s property (incorporeal or not), as otherwise the mortgagor would not be able to transfer the property as it would belong to the mortgagee.³¹⁸ The ability of a company to transfer mortgaged property is further emphasised by Gloag and Irvine when they note that if the business of the company requires the sale of “some portion of the property contained in the wide phrase ‘undertaking,’ the sale

³¹¹ Gloag and Irvine, *Security*, 629. The former’s provisions apply to any company incorporated by Act of Parliament, except in so far as varied by provisions of the private Act; the latter statute only applies where it is expressly incorporated by the private Act.

³¹² This reflects the Acts noted above (see text corresponding to n 288). An equivalent definition is also found in the Lands Clauses Consolidation (Scotland) Act 1845, s 2.

³¹³ 1845 Act, s 43.

³¹⁴ Gloag and Irvine, *Security*, 632ff, are not entirely clear on this issue.

³¹⁵ 1845 Act, s 48. There is no stated penalty for non-compliance.

³¹⁶ Gloag and Irvine, *Security*, 632.

³¹⁷ *Ibid.*

³¹⁸ For some consideration of the extent and effect of the security here, see *Cotton v Beattie* (1889) 17 R 262. This is cited by GW Wilton, *Company Law and Practice in Scotland* (1912), 640f, who suggests the security is real security. However, a judicial factor is required to enforce the “mortgage” (this also undermines the view that the mortgage is actually an assignation in security of the property).

could probably be made without obtaining the consent of the mortgagees... and the property so sold would pass to the purchaser free from any charge on the part of the mortgagee.”³¹⁹ The influence of English law here is palpable, from the terminology, to the characteristics of the “mortgage” of an “undertaking” in accordance with the floating charge of English law.

Gloag and Irvine add that a mortgage in statutory form, though it “assigns” the undertaking, does not necessarily “assign” all the property of the company.³²⁰ They cite the decision in *Gardner*³²¹ that a mortgage of an undertaking does not convey any right to “surplus lands” belonging to the company or sums received from the sale of these lands. But reference is also made to cases which provide that possession of tolls by mortgagees, through a receiver, is sufficient to give a preference over an “ordinary judgment-creditor”.³²² According to Gloag and Irvine, the rights of a mortgagee which are probably “of most practical importance” are the rights to rank as a preferred creditor over the company’s property if it is insolvent, and the right to make the security effective immediately by petitioning for a judicial factor.³²³ Related to this, the 1863 Act, s 31, provides that debenture stock shall be considered to entitle its holder to the rights and powers of a mortgagee of the undertaking other than the right to require repayment of the principal sum paid up in respect of the stock. This is considered by Gloag and Irvine to confer the right to rank as “preferred creditors” on the company’s “general assets”, and the right of the mortgagee “to make their general security specific” by applying for a judicial factor.³²⁴ And they suggest that debentures issued in Scotland under the Companies Clauses Acts are comparable to English floating charges (granted by registered *or* private Act companies).³²⁵ There are also unmistakable analogies here with the later Scots law floating charge: the floating charge’s ranking preference in liquidation and the ability to seek liquidation or the appointment of a receiver and thus cause the floating charge to attach.

The *Eighth Report* also drew comparisons between receivers appointed by chargeholders and the use of judicial factors for enforcement purposes under the Companies Clauses Acts³²⁶ and

³¹⁹ Gloag and Irvine, *Security*, 632f.

³²⁰ *Ibid*, 633.

³²¹ N 289.

³²² *Ibid*; *Potts v Warwick and Birmingham Canal Navigation Co* (1853) Kay 142; *Ames v Trs of Birkenhead Docks* (1855) 20 Beav 332.

³²³ Gloag and Irvine, *Security*, 633.

³²⁴ *Ibid*, 636.

³²⁵ *Ibid*, 634ff.

³²⁶ 1845 Act, s 56f and 1863 Act, ss 25f.

the Railway Companies (Scotland) Act 1867, s 4.³²⁷ It was acknowledged that the duties of a judicial factor appointed under the first-mentioned Acts are limited to receiving tolls and other sums due and paying the mortgagee (or debenture holder); however, the 1867 Act was noted to give a judicial factor power to manage the undertaking of the company and its whole works and property and to enter into negotiations for the sale of the undertaking.³²⁸ Consequently, when the floating charge was introduced, there was a recognised close connection between the term “undertaking” and the company’s property. Yet there was certainly no notion that the term itself introduced English conceptions of property or equity in place of property in Scots law.

In any case, the aforementioned material shows that when the floating charge arrived in Scots law, specific types of legal person (those created by private Acts) could already grant a floating charge-esque security device.³²⁹ The same can be said about agricultural charges, which could (and can) be granted under the 1929 Act, ss 5ff, by agricultural societies registered in Scotland under the Industrial and Provident Societies Acts 1893 to 1928. Thus, although the floating charge was novel and has had a much greater impact than these other securities, it also constitutes just one example of particular legal entities being allowed to grant floating charge-type securities, based on an English model, but adapted in order to better conform to the existing laws of Scotland.³³⁰

³²⁷ See paras 36ff. Of course, despite making this comparison, the LRCS rejected the introduction of both. (Appointing a judicial factor is available under s 4, as a substitute for diligence, to a party that has obtained decree.)

³²⁸ Para 37; *Haldane v Girvan and Portpatrick Junction Railway Co* (1881) 8 R 1003; but not apparently to sell the undertaking without the court’s authority: see *Haldane v Rushton* (1881) 9 R 253.

³²⁹ This was not considered in either *Ballachulish* (n 1) or *Carse* (n 1), which dealt with Companies Acts-registered companies. AJM Steven, “One Hundred Years of Gloag and Irvine” 1997 JR 314 at 326 contends that the possibility of a company granting a floating charge under the 1863 Act, s 31, as suggested by Gloag, is mistaken, on the basis of *Carse*. However, a distinction must be drawn between companies and undertakings established by private Acts of Parliament and those registered under the general Companies Acts.

³³⁰ For example, agricultural charges followed on from the charges available under the English legislation of the previous year, the Agricultural Credits Act 1928, but are “enforced by sequestration and sale... in like manner in all respects as in the case of the hypothec of a landlord” – 1929 Act, s 6(1). Agricultural charges are also unusual in that they can only be granted to a certain type of entity: a “bank”, as defined in s 9(2). Meanwhile, the general restrictive law regarding security rights remains in place.

(c) “Property” in Scots Law

Of course, in comparison to undertaking, the term “property” has a deep and rich provenance in Scots law. However, although the assertion that “property” does not have a technical meaning is somewhat absurd,³³¹ the term can be used in different ways. Stair describes “property” as the “main real right”.³³² While *Bell’s Dictionary*, citing institutional authorities, states that property “is the exclusive right of using and disposing of a subject as one’s own.”³³³ In this context, “property” is used to describe a particular right in a thing or object. But, in other contexts, “property” refers to objects or things themselves. This is acknowledged by Reid, who also suggests that the term “law of things” is more strictly accurate than property law.³³⁴ He notes that “property law is the law of things, and of rights in things (real rights).”³³⁵

Given that the floating charge legislation was inserted into Scots property law, and the term “property” was not given a special definition, it should be presumed that “property” in this context corresponds to one or more of the established meanings in Scots law.³³⁶ However, as shall be seen, there is divergence between the modern understanding of property in Scots law and its meaning in the floating charges legislation.

³³¹ See chapter 7 for discussion of this in the context of *Sharp*.

³³² Stair, II, 1, 28.

³³³ *Bell’s Dictionary*, 864f. It is added that “the proprietor of a subject, whether heritable or moveable, may give it away or sell, or burden, or pledge it, or create a servitude over it.” And see Stair, II, 1, 28; Erskine, *Institute*, II, 1, 1; Bell, *Principles*, ss 938ff, 1283f; Bankton, I, 10, 84, 504, 529 and III, 51.

³³⁴ Reid, *Property*, para 3, n 1. As Reid also notes, German law and South African law are examples of systems where “thing law” (*Sachenrecht* and *Sakereg* (in Afrikaans) respectively) is used for the equivalent of our property law. See also Paisley, *Land Law*, para 1.8.

³³⁵ Reid, *Property*, para 11.

³³⁶ Comparison can be drawn with the 1979 Act, ss 2, 16ff (and formerly the 1893 Act, ss 1, 16ff) where “property” is used rather than ownership. The influence of English law and terminology is notable in both pieces of legislation.

C. THE MEANING OF “PROPERTY... COMPRISED IN [THE COMPANY’S] PROPERTY AND UNDERTAKING”

(1) Two Uses of “Property”

The term “property... comprised in [the company’s] property and undertaking” is used in the provisions for the floating charge’s creation and its attachment in liquidation. And it also applies to the receivership and administration attachment provisions, due to their necessary connection to the property affected by a charge after its creation. The term is therefore fundamentally important for the charge’s operation and must be unpicked. The first use of “property” in the phrase means “things”. Anything deemed to be property in Scots law would therefore fall within the term’s meaning.³³⁷ In Scots law, incorporeal property is almost always included within the meaning of property.³³⁸ Consequently, the most likely explanation for the content of the first “property” reference is that it is all things traditionally recognised as property in Scots law: corporeals and incorporeals, heritables and moveables. An alternative view is to regard things here as rights, real or personal, dependent upon the object in question.³³⁹ This latter position is attractive given the preferable interpretation of the second usage of property noted below.

The second use of property in the phrase above is even tougher to untangle. The words “comprised in [the company’s] property and undertaking” appear to require that the property identified in the first sense above belongs to the company in some way. The use of “property” in this second part of the phrase is either, once more, property in the sense of things, or it means in the company’s ownership. If it is the latter, it must mean ownership in a wide sense to include incorporeal property. The first meaning of property extends to such property, thus making all different types of property potential objects of “ownership”. Either way, the connection between property here and the possessive reference to the chargor means that there

³³⁷ In *Independent Pension Trustee Ltd v LAW Construction Co* 1997 SLT 1105 it was held that a floating charge attached not only property in a “narrow sense” but also rights and powers insofar as they have “commercial value or significance”. See also McKenzie Skene, *Insolvency*, 168.

³³⁸ Cf eg German law, where “things” (Sachen), which is often equated to “property”, is limited to corporeal objects: BGB §90 Begriff der Sache – “Sachen im Sinne des Gesetzes sind nur körperliche Gegenstände.”

³³⁹ See GL Gretton, “Ownership and its Objects” (2007) 71 *Rebels Zeitschrift* 802.

is a necessary relationship between the company and the property. In this context the advantage of considering things to mean rights, rather than items of property, is apparent. Scots property law is structured on the basis of rights, personal and real, and here this analysis would provide an obvious answer. If the company held (or “owned”) a particular right, then it would be that party’s “property”. Consequently, when it is said that a floating charge attaches to eg an item of corporeal property, this is shorthand for the charge attaching to the chargor’s right of ownership in the corporeal object. By contrast, if the second use of property translates as the company’s object or thing, this postpones and obfuscates the question of what legal relationship the company needs to have with a particular thing. This approach to “property”, along with the interpretation of the accompanying term “undertaking”, enabled the court in *Sharp* to adopt a meaning divorced from the personal and real rights foundation of Scots property law.³⁴⁰

(2) “Property and Undertaking”

The meaning of “undertaking” in the floating charge legislation is a question of further difficulty. As noted above, it seems to have been intended as a means to secure all present and future property of a company and to allow for the company’s business ultimately to be sold as a going concern to satisfy the debt due to the chargeholder. However, the term, especially when paired with “property”, is open to interpretation.

It is sensible to analyse the possible meanings of “property and undertaking” using ownership in Scots property law. This can be justified on a number of grounds. Ownership is used as a synonym for one of property’s meanings, the highest form of real right, and thus is readily distinguishable from mere personal rights. It is a readily understood and well-defined concept in Scots property law. Ownership is also unititular so it can be easily traced to one particular party and the point of transfer for property (of all types) is clearly identifiable where ownership is the measuring stick.³⁴¹ Despite the decision reached by the House of Lords in *Sharp*, Lord Clyde seems to have accepted the First Division’s interpretation of general heritable property law and the acquisition of ownership (title).³⁴² This perspective was affirmed in *Burnett’s*

³⁴⁰ As beneficial interest does not fit within the personal and real rights model.

³⁴¹ See chapters 7-9 for rules for particular property types.

³⁴² At 80.

*Tr.*³⁴³ And legislation has further clarified the position for heritable property.³⁴⁴ Ownership's role in the context of attachment of a floating charge is also a potential dividing line in the opinions of Lords Jauncey and Clyde in *Sharp*.³⁴⁵

(a) Four Approaches

Where property is in a company's "property and undertaking" this means a floating charge (created by the company) can attach. As such, determining the relationship between ownership and attachment helps us to understand the term's meaning. If we consider whether ownership is a necessary and/or sufficient criterion for the attachment of a floating charge, this gives us four possibilities: (1) ownership is necessary and sufficient (full ownership attachment approach); (2) ownership is necessary but insufficient (limited ownership attachment approach); (3) ownership is unnecessary but sufficient (limited equitable attachment approach); and (4) ownership is neither necessary nor sufficient (full equitable attachment approach). These approaches are more clearly outlined in the following table.

	Ownership sufficient	Ownership not sufficient
Ownership necessary	Full ownership attachment approach (1)	Limited ownership attachment approach (2)
Ownership not necessary	Limited equitable attachment approach (3)	Full equitable attachment approach (4)

The differences between these approaches are best highlighted by an example. A Ltd grants a floating charge to B Bank. And C Ltd grants a floating charge to D Bank. Subsequently, A

³⁴³ See, in particular, Lord Hope at paras 11ff, and Lord Rodger at paras 87ff.

³⁴⁴ 2012 Act, s 50(2), and, formerly, the Abolition of Feudal Tenure etc (Scotland) Act 2000, s 4.

³⁴⁵ See 99ff and 167ff for further details.

Ltd wishes to transfer property to C Ltd. The next table provides details as to whether the floating charges can attach under each approach.

Full ownership attachment approach (1)	Limited ownership attachment approach (2)
<p>If A Ltd still owns the property, B Bank's floating charge can attach to the property.</p> <p>If C Ltd does not yet own the property, D Bank's floating charge cannot attach to the property. (D Bank's floating charge can, however, attach to a personal right to acquire the property).</p>	<p>If A Ltd still owns the property, B Bank's floating charge can attach to the property, but will not do so under certain circumstances.</p> <p>If C Ltd does not yet own the property, D Bank's floating charge cannot attach to the property. (D Bank's floating charge can, however, attach to a personal right to acquire the property).</p>
Limited equitable attachment approach (3)	Full equitable attachment approach (4)
<p>If A Ltd still owns the property, B Bank's floating charge can attach to the property.</p> <p>However, B Bank's floating charge may attach to the property even if A Ltd no longer owns it.</p> <p>If C Ltd does not own the property, D Bank's floating charge may still be able to attach to the property. (D Bank's floating charge can also attach to a personal right to acquire the property).</p>	<p>Whether or not A Ltd still owns the property does not determine if B Bank's floating charge attaches to the property.</p> <p>Whether or not C Ltd owns the property yet also does not determine if D Bank's floating charge can attach. (C Ltd's holding of a personal right to acquire the property may also not determine whether D Bank's floating charge can attach to this).</p>

The only one that is (almost) entirely clear in its scope, and from which the outcome in any given case is readily discernible, is approach (1). This is because it is formalistic and coheres with property law. For the other approaches, the non-ownership elements are ill-defined and problematic due to the necessary interaction between the underlying property law and the floating charge. These approaches utilise a greater degree of functionality, responsiveness and (arguably) “fairness” in particular circumstances, in comparison to approach (1). In other words, there is greater individual equity inherent in them. The principal reason for adopting such an approach would appear to be as a counter-measure to the apparent unfairness of the floating charge, in terms of its potential reach and ability to otherwise capture, for example, both the price paid and the property in a sale transaction.³⁴⁶ Consequently, approach (3) has

³⁴⁶ See *Sharp* and 167ff.

little to recommend it: protection is not given to a party in the process of acquiring property, as B Bank's floating charge can still attach, and it may even allow D Bank's charge to attach as well.

Approach (2) gives protection to those engaging with a party that has granted a floating charge. It also has the advantage of using ownership as an identifiable anchor but there are specific situations, as yet not mapped out, in which this is not enough to stop property drifting out of a floating charge's reach. Uncertainty also abounds with the alternative to ownership in approach (3). Approach (4) offers the least certainty but the most flexibility. For that approach, ownership might be an indicator of what is necessary for the floating charge to attach but the required conditions for attachment are independent of ownership. Although this may seem the most commercially-focused approach, the interests of commerce also depend upon certainty from the law. By contrast, this approach would mean that each case would have to be considered on its merits, at least until the relevant factors determining attachment are identified. The necessity of having to scope out exactly what the other factors are for attachment, and when these arise, is a significant disadvantage for approaches (2) to (4).

(b) The Approaches and Property and Undertaking

In any event, for an approach to be valid, it must correspond to the company's "property and undertaking". This term may constitute one concept comprised of two components. But, assuming the components are not exact equivalents, the meaning of one could be narrower than the other, and be subsumed within it. For example, undertaking might be all of the property owned by the company less certain things (see *Figure 2*), or all of the property owned by the company plus some additional things (see *Figure 3*). (But, if one falls entirely within the other, it can be queried why the legislation does not just refer to the narrower one.) An alternative is that they are two distinct and independent concepts both of which must be met in a given case for a floating charge to attach. Therefore, ownership of property does not mean that the thing is automatically in the undertaking or vice versa. Yet a thing must be able to fall into both in particular circumstances, as otherwise attachment would not be possible (see *Figure 4* and *Figure 5*). It should be noted that if a floating charge attaches to more than a company owns, then there would be problems establishing how the charge could be enforced through a liquidator, administrator or receiver, as the property would be within the patrimony

of another, and therefore only subject to that party's insolvency.³⁴⁷ This is a major problem for approaches (3) and (4). A further issue for these approaches is that if ownership is not a necessary condition for attachment, it must be questioned what the charge actually attaches to.



Figure 2

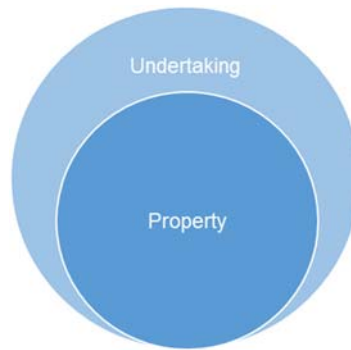

Figure 3



Figure 4

This figure shows that property and undertaking could be two distinct concepts which require to be met.

³⁴⁷ See 134ff for more details.

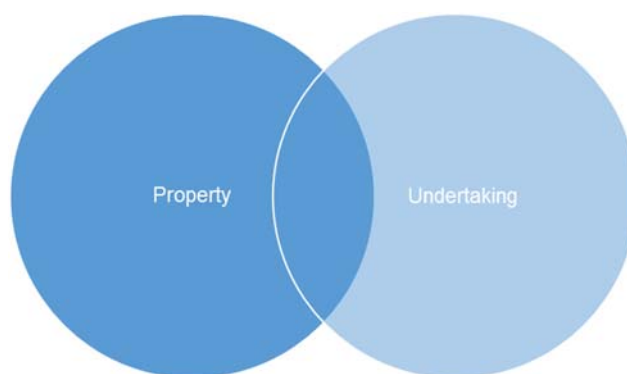

Figure 5

However, there will be particular facts and circumstances which fall within an overlap area allowing for both parts of the test to be met.

For approach (1), “property and undertaking” is a single concept that incorporates all of the property owned by the company. It is also possible that the use of undertaking gives a more expansive meaning to the term, which allows for additional property to be included. As already noted, a core meaning of undertaking is all of the company’s present and future property. This could enable attachment to property that is not the company’s when attachment occurs, but is subsequently acquired.³⁴⁸ Conversely, it could exclude property that is validly transferred after attachment.³⁴⁹ Such an interpretation would also be consistent with undertaking corresponding to an ongoing business with fluctuating property, even if this trading is being continued by a receiver, administrator or a liquidator. Alternatively, undertaking could allow for a charge to attach to certain assets not usually considered (separately) “ownable”, “transferable” or “securable”.³⁵⁰ An additional possibility is that it limits the property to the company’s personal patrimony (therefore excluding any trust property), as arguably only the property in this patrimony is generally part of the business. It may also have been intended to exclude property “obtained” by the chargor through ultra vires acts, although this exclusion would no longer apply.³⁵¹

³⁴⁸ See 57ff.

³⁴⁹ See 134ff.

³⁵⁰ Eg goodwill, or non-transferable or non-securable property, such as certain non-assignable personal rights. For the latter, see 234ff.

³⁵¹ See above.

Furthermore, the use of “undertaking” could have an impact on how enforcement takes place. In Scots law, a secured creditor ordinarily enforces by selling the specific item of property over which the security is granted. If the floating charge were to reflect the position for real security, which is plausible given its attachment as a “fixed security”, this could mean that property items would have to be individually sold to pay the chargeholder.³⁵² This would preclude the possibility of the whole business (or part of it) being realised.³⁵³ Although this would not limit a liquidator’s ability to deal with the estate, as the liquidator’s powers are independent of the floating charge, it might restrict the way a receiver, as a party specifically introduced to enforce a floating charge, could deal with the chargor’s property and business. If applicable, it also means that a receiver can otherwise control and realise the chargor’s estate as a unified whole rather than having to deal with a fragmented collection of property. This meaning of undertaking would not have had an immediate effect when the charge was introduced, as it awaited the introduction of a specific floating charge enforcement mechanism. However, connecting “undertaking” to enforcement through the sale and control of the business as a whole also corresponds to a particular identified meaning of the term when the charge was introduced.³⁵⁴

As regards approach (2), “property and undertaking” has a meaning which is more limited than the ownership of property alone. This is either because undertaking limits the meaning of property when combined with it (so that, for example, a thing must fall within the inner area of *Figure 2* to be attached) or because they are distinct concepts without undertaking being entirely confined within ownership (see *Figures 4* and *5*).

If we consider property and undertaking to be separate and independent (see *Figures 4* and *5*) then only one of these would require to be met according to approach (3), but this disjunctiveness is at odds with the conjunctive “and” in “property and undertaking”. This is less problematic where property and undertaking are one concept (see eg *Figures 2* and *3*) and the term’s meaning is expansive enough to include property that is not owned by the chargor.

³⁵² But it may be possible to sell items collectively if the debtor has agreed to this.

³⁵³ On a related note, the 1986 Act distinguishes between the company’s business and its property, in a similar manner – see eg Sch 2, para 19, which states that a receiver has the “Power to transfer to subsidiaries of the company the business of the company or any part of it and any of the property.”

³⁵⁴ See 81f.

Finally, under approach (4), “property” and “undertaking” separately do not mean ownership, nor is ownership a necessary component of them as a combined term (see *Figures 2, 3, 4 and 5*). The alternative meaning of property in this context is hard to ascertain. However, it could correspond to “beneficial interest”, as identified in *Sharp*.

(c) Current Law

Approach (1) was considered by many to reflect the law of floating charges prior to the House of Lords decision in *Sharp*. Indeed, the Outer House and the Inner House in that case adopted such a position.³⁵⁵ It is the approach which most obviously integrates the floating charge into existing Scots property law. (However, prior to *Burnett’s Tr*, the Scots law position regarding transfer of ownership of heritable property was contentious.)

A careful reading of Lord Clyde’s judgment in *Sharp* suggests that he may favour approach (2). He seems to propose that ownership and “beneficial interest” are required for a floating charge to attach.³⁵⁶ According to approach (2), beneficial interest is not necessarily the only further required element (in addition to ownership).³⁵⁷ But it may represent the present law, on the basis of Lord Clyde’s opinion. Approach (3) has not found obvious favour amongst either academics or judges. Meanwhile, Lord Jauncey in *Sharp* may lean towards approach (4).³⁵⁸ His view appears to be that attachment corresponds to whether the chargor has beneficial interest in the property concerned. Opinions expressed by commentators can also be analysed using the ownership framework. For example, Professor McDonald did not think that, in a *Sharp* scenario, the transferor-granted floating charge ought to attach and suggested that a receiver of the transferee would expect that the property was within the transferee’s

³⁵⁵ And see the commentary on *Sharp* discussed at 172ff. Also note *Hawking v Hafton House Ltd* 1990 SC 198, in which it was held that sums consigned to the clerk of court were no longer part of the company’s “property” and therefore were not subject to a receiver’s powers; and see *Greene and Fletcher: Receivership*, para 2.36. Another case relevant to the meaning of “property” is *Myles J Callaghan Ltd v City of Glasgow District Council* 1987 SC 171, in which it was held that property attached in a receivership is subject to rights such as “set-off” for pre-liquidation debts. The outcome would no doubt have been the same if the charge had, instead, attached upon liquidation.

³⁵⁶ See further 186ff.

³⁵⁷ Other potential elements have not been formally identified. However, see eg the discussion of Wilson’s analysis at 214ff.

³⁵⁸ And despite generally favouring (2), some of Lord Clyde’s dicta is in this direction too.

property and undertaking, prior to title being completed.³⁵⁹ He therefore seems to have favoured approach (4). On the basis of *Sharp*, either approach (2) or approach (4) is the current position in Scots law, at least for the transfer of heritable property and attachment in receivership.³⁶⁰ If the ratio is limited to certain types of property, sale transactions, or receivership, then one of the other approaches represents the applicable law in areas beyond those to which the ratio applies.

Approaches (2) and (4) converged in *Sharp*, but there are alternative circumstances in which they would diverge. For instance, if beneficial interest but not ownership had passed from A Ltd to C Ltd in the example above, D Bank's floating charge could attach under approach (4) but not approach (2). In reality, this might make little difference as D Bank's floating charge would, in all likelihood, attach to a personal right to acquire the property. But this right could be defeated if A Ltd were to become insolvent in the meantime, as other creditors of A Ltd could claim the property too.³⁶¹ And how could the floating charge even be enforced in the insolvency of a party other than the chargor? In addition, the consequences arising from (2) and (4) appear to differ where ownership of property is transferred for the purposes of security. Let us assume beneficial interest is the additional attachment element for (2), and the only element for (4), and that A Ltd transfers property, in security, to C Ltd, yet A Ltd retains beneficial interest. In neither case would D Bank's charge attach; however, B Bank's floating charge would do so under approach (4) but not approach (2). This difference between an "equitable approach", epitomised by (4) (and also provided for by (3)), and an approach for which ownership by the chargor is necessary, can have significant implications for the attachment and ranking of a floating charge.³⁶² Yet approaches (3) and (4) face the sizeable obstacle that floating charges are enforced through mechanisms which are proprietarily limited to the chargor's patrimony. For charges to function upon attachment, where property is not owned by the chargor, may depend upon an interpretation of Scots property and insolvency law that corresponds with beneficial interest rather than ownership. This would provoke much uncertainty and is not justified under the current law.³⁶³

³⁵⁹ AJ McDonald, "*Sharp v Thomson*: Feudal Purism – But is it Justice?" (1995) 40 JLSS 7 at 9.

³⁶⁰ See 176ff. And see 212ff and 238f.

³⁶¹ And their rights would be dependent upon A Ltd's ownership of the property.

³⁶² See, especially, 264f.

³⁶³ See chapters 6-9, passim.

An issue with approach (2) is that, at some point during certain sale transactions, neither B Bank nor D Bank’s floating charges can attach to the property being sold. It seems illogical if, at a currently indeterminate point, floating charges granted by A Ltd and C Ltd, over all of the property in their respective property and undertakings, cannot attach to property being transferred from one to the other.³⁶⁴ For purposes such as insolvency, the property would be part of the transferor’s patrimony, due to that party’s ownership of the thing.³⁶⁵ A particular difficulty is demonstrated by the table below. If there is a gap in coverage (a “no-man’s land”), there are two indistinct borders to identify and overcome. We must determine when the floating charge granted by A Ltd becomes non-attachable and also at what point the floating charge becomes attachable by the charge granted by C Ltd. It is also unclear whether it would be possible to move backwards once a new “zone” is entered, and when this would happen. The position can be contrasted with the simplicity of approach (1), in which there is one clearly-defined boundary, and the property can only fall in one of two sectors. With approach (4) there might only be two sectors but identifying the border point is currently an impossible task.

Sale transaction – property transferring from A Ltd to C Ltd			
Seller (A Ltd)  Buyer (C Ltd)			
Approach (1)	Floating charge granted by A Ltd attachable		Floating charge granted by C Ltd attachable
Approach (2)	Floating charge granted by A Ltd attachable	Neither floating charge attachable	Floating charge granted by C Ltd attachable

It may be contended that the “no-man’s land” is a false lacuna in practice. A contractual right to acquire the property will be held by C Ltd and thus can be attached by D Bank’s floating charge. A Ltd could be compelled to perform and the transferred property would become attachable by D Bank’s charge, once ownership was obtained by C Ltd. But if A Ltd has

³⁶⁴ There can, of course, also be exceptions to universalities, for various reasons; consider eg the diligence of attachment which applies to all corporeal moveables but from which certain articles are exempted – see Debt Arrangement and Attachment (Scotland) Act 2002, s 10f.

³⁶⁵ See chapters 6-9, passim.

entered an insolvency process, there is a problem. A liquidator or equivalent would not have to fulfil an obligation to transfer the property. Does this mean the property would revert back to the “property and undertaking” of A Ltd and become attachable by B Bank’s charge? And, if so, when and how would this occur? There are no satisfactory answers here.

Whichever of (2) or (4) represents the current law, however confined or expansive, they are flawed approaches. As already outlined, (1) is preferable for a number of reasons, not least its coherence with Scots property and insolvency laws and its straightforward operation. In addition, as will be shown in chapters 6 and 7, the justifications for (2) and (4) arising out of the deemed unfairness in the particular circumstances of *Sharp* can be satisfied without damage to the concept of property and its relationship with the floating charge.

(d) The Approaches and the Attachment Mechanism

The different theories regarding the attachment mechanism of the floating charge will be discussed in the next chapter. But how do these theories fit with the various property attachment approaches? When considering property attached and the mechanism of attachment, it is proper to first examine whether property is attached, as only then does the effect of such attachment have meaning.³⁶⁶ However, in more general terms, given that the floating charge attaches “as if” it is a “fixed security”, greater credence ought to be afforded to a property attachment approach which facilitates the attachment mechanism in an understandable manner. It might seem irrational if a floating charge could attach as a fixed security, given that the chargor did not have the power to grant such a security over the property at that time.

The prevailing “statutory hypothesis” analysis clearly aligns with attachment approaches where ownership is necessary. Fixed securities can generally only be granted by the owner of property.³⁶⁷ Therefore, allowing a floating charge to attach to property not owned by the chargor is inconsistent with the attachment mechanism. It might be argued that the statutory hypothesis supports approach (2) more than approach (1), at least for some property. This is

³⁶⁶ On this, see eg the discussion in Rennie (n 21) at 177.

³⁶⁷ There are, however, some statutory exceptions: Conveyancing (Scotland) Act 1924, s 3; 1970 Act, s 12; and see Reid, *Property*, para 644.

because ownership is not the only legal requirement for creating a fixed security over certain property. For example, a pledge requires the delivery of property to the pledgee and for that party to maintain possession. Yet this argument is undermined by the fact that even though the pledgor has insufficient possession to confer a second pledge, and a chargeholder does not possess the property, a charge can attach to property pledged to another. There is, consequently, disparity between the requirements, beyond ownership, for creating particular security rights and the attachment of a charge.

The additional requirement(s) for attachment under approach (2) (ie beyond ownership) also do not always match up with the legal conditions for creating a fixed security. This is the case where beneficial interest is the additional requirement and this passes to the transferee, even though the transferor still has the power to grant a fixed security over the property, as was the case in *Sharp*. It could be argued that being able to grant a fixed security refers to a security that is not voidable. But this might mean very few floating charges would attach, as any fixed security granted at the time when a floating charge attaches upon liquidation, or when the chargor is otherwise insolvent, would likely be voidable as an unfair preference. For simplicity, there is again much to commend approach (1), as these issues are evaded.

The “*sui generis*” mechanism theory also corresponds to attachment approaches requiring ownership. A party cannot (generally) grant a fixed security over property it does not own, which undermines the application of non-ownership approaches. Under the *sui generis* theory, a charge attaches as if it were a generic security over property that is effective in the chargor’s winding up.³⁶⁸ The property within the estate of a chargor in winding up is the property owned by that party. Therefore, the charge may be considered to attach to property that the chargor company owns. Indeed, the fact that the floating charge is enforced through insolvency mechanisms and officeholders suggests that property needs to be within the chargor’s insolvent estate for the charge to affect property.³⁶⁹ As approach (1) only requires ownership by the chargor for a charge to attach, it clearly explains what is attached, and most neatly aligns with insolvency law and the meaning of fixed security in that context. By contrast, the other approaches involve an unwarranted dissonance between: what is necessary for

³⁶⁸ Corresponding to the definition(s) of “fixed security” – see 1985 Act, s 486(1) and 1986 Act, s 70(1).

³⁶⁹ See chapter 6.

attachment, the relevant attachment mechanism (whether it is the prevailing statutory hypothesis or a *sui generis* interpretation) and insolvency law.

CHAPTER 5

THE ATTACHMENT HYPOTHESIS

A.	LEGISLATIVE HISTORY	105
(1)	The 1961 Act.....	106
(2)	Later Legislation	109
B.	STATUTORY HYPOTHESIS.....	110
(1)	Competing Theories of Attachment	110
(2)	The Integrated Approach.....	111
(3)	The <i>Sui Generis</i> Approach.....	112
C.	A SECURITY <i>SUI GENERIS</i> ?.....	113
D.	THE NATURE OF THE ATTACHED CHARGE	117

A. LEGISLATIVE HISTORY

Upon crystallisation in English law, the floating charge becomes a fixed charge over each item of property.³⁷⁰ This was already long-established by the time the floating charge was introduced into Scots law.³⁷¹ By contrast, Scots law did not have a fixed charge or other security right which applied across different property types (except trusts). Instead, it had, and has, specific security rights which correspond to certain types of property. In this sense, the Scottish system of security rights is less unitary and more fragmented than the English law system.³⁷² And as Gretton notes, the flexibility of the English charge concept can be contrasted with the clear defined existing institutions of Scots law.³⁷³

³⁷⁰ See eg *NW Robbie* (n 182); *Buchler v Talbot* [2004] UKHL 9; [2004] 2 AC 298, especially per Lord Hoffmann at para 29; Goode, *Legal Problems*, para 4-32.

³⁷¹ See eg *Evans v Rival Granite Quarries Ltd* [1910] 2 KB 979.

³⁷² English law too has certain security rights corresponding to particular types of property but to a lesser degree than Scots law and has security rights such as mortgages and charges that apply to various property types.

³⁷³ See Gretton (2003) (n 8) at 315. The defined nature of the existing Scots law security rights, as opposed to the unknown charge, was no doubt an attraction for adopting the integrated attachment approach (see further below).

The floating charge in English law fits more readily within the established category of equitable charge, whereas in Scots law there is no such category and no system of equity. The notion of a general category of real rights in security was underdeveloped in Scots law, even in 1961. But the arrival of the floating charge represented a step towards a more unified approach to security rights: as well as being a security available over all types of property, the charge also brought with it the construction of a previously non-existent concept of “fixed security”, which applies across the full range of property law and is used for the floating charge’s attachment effect.

(1) The 1961 Act

When the floating charge was being introduced, it was considered necessary to produce a general attachment effect similar to the English position but within the Scottish context. The 1961 Act, s 1(2), stated that the provisions of the 1948 Act relating to winding up, except s 327(1)(c),³⁷⁴ would have effect “as if the charge were a fixed security over the property to which it has attached...”. The wording of the 1961 Act suggested that the floating charge only attached as if it were a fixed security for the purposes of the winding up provisions in the 1948 Act. This was an apparent departure from the *Eighth Report*, which stated that the floating charge would “crystallize” and “become a fixed security” over assets subject to the charge upon liquidation.³⁷⁵

Correspondence involving Gibson, who assisted with the Bill that became the 1961 Act, sheds light on the intended meaning of the attachment effect provision that was ultimately included. Within the Bill as it then stood, the floating charge was simply to have effect as if it were a fixed security, which, it was supposed, implied that the property subject to the floating charge could be sold by the chargeholder. Yet there were no provisions enabling this, and it was considered too problematic to attempt it, given the potential variety of property involved.³⁷⁶ It was also noted that the holder of a *fixed security* would, upon liquidation, have a right *in rem*

³⁷⁴ This was a provision relating, *inter alia*, to the sale of heritable property by a secured creditor.

³⁷⁵ See paras 42 and 52. References to the English term “crystallization”, incorporated in early versions of the Bill, were removed – see Scottish Standing Committee, 20 June 1961, col 7 (Forbes Hendry).

³⁷⁶ NRS AD63/481/1 – letter from JH Gibson, Lord Advocate’s Department, to F Hendry, House of Commons dated 8 June 1961. It was stated that this was not intended as a suggestion for what was to be said in parliamentary proceedings.

to the property. However, a chargeholder would only have “a sort of postponed preferential claim, to the extent of the value of the property subject to the charge”.³⁷⁷ The postponed element of the claim referred to the priority to be given to preferential creditors in terms of s 319 of the 1948 Act. The analysis of the floating charge as a preferred claim reflected its status as a fixed security right for ranking purposes, but with enforcement limitations. Cook, a member of the LRCS, agreed with Gibson, stating that the right of a chargeholder in terms of the Bill was “in reality a postponed preferential claim over the proceeds of the assets subject to the charge” and that it was therefore “not necessary to provide that the charge crystallizes into a fixed security on liquidation.”³⁷⁸

What was apparently desired was “to arrange that the holder of the charge will get the benefit of the charge through the liquidator”.³⁷⁹ It was suggested that this was “not dissimilar” to saying that the chargeholder would be “like an unsecured creditor but preferred, as against the general unsecured creditors, to the extent of the property charged”. Yet it was acknowledged that this could not be stated directly as it would be anomalous compared to other parts of the Bill, in which the floating charge had some of the characteristics of a security, such as for ranking. The replacement provision contained within the 1961 Act therefore provided that the floating charge attached as if it were a fixed security for specifically limited purposes.

During the Bill’s progress through Parliament, some further explanation of the attachment mechanism was provided. Immediately prior to moving the Bill for second reading in the House of Lords, Viscount Colville of Culross mentioned that the provision regarding the effect of the floating charge’s attachment seemed, at first glance, a “most obscure phrase”.³⁸⁰ He stated that it had been included to attract s 61 of the Bankruptcy (Scotland) Act 1913, as applied by s 318 of the 1948 Act, so that upon liquidation the floating charge would be considered a security under the legislation (for the valuation and ranking of the charge on the estate). This would give the chargeholder the means to acquire, from the liquidator, sums due to it, as if it were a fixed security holder. Importantly, he stated that the phrase “does not mean

³⁷⁷ NRS AD63/481/1 – copy letter from JH Gibson, Lord Advocate’s Chambers, to WA Cook, Biggart, Lumsden & Co, dated 18 May 1961.

³⁷⁸ NRS AD63/481/1 – letter from WA Cook, Biggart, Lumsden & Co, to JH Gibson, Lord Advocate’s Chambers, dated 31 May 1961.

³⁷⁹ Letter from Gibson to Hendry (n 376). And see copy letter from Gibson to Cook (n 377).

³⁸⁰ HL Deb, 5 July 1961, vol 232, col 1437.

that the floating charge can be considered to be a fixed security for any other purpose”.³⁸¹ His Lordship also noted that an ordinary fixed security can be “dealt with in the market, it can be sold and it can be subject to various other transactions. Not so the floating charge, which is only a fixed security for this one purpose of liquidation; it cannot be realised in any other way than on liquidation.”³⁸² The reference to the selling of the security superficially appears to involve assigning the security right itself. However, the passage is more intelligible, especially given the final reference to realisation of a charge in liquidation, if we consider Viscount Colville to have actually meant that a fixed security holder could sell the property secured, or otherwise deal with it, in a way that a chargeholder could not.³⁸³ In any event, a clear contrast is drawn between the limited fixed security effect of the floating charge and fixed securities proper.

It is noteworthy that parties involved with the 1961 Act considered a “fixed security” would give its holder a right in particular property enabling them to sell it. The Royal Faculty of Procurators in Glasgow, who responded to the Bill, were of a similar view, noting that the floating charge even after attachment, did not operate as a security, especially a fixed security, as the characteristic of a security was that it could be operated by its holder independent of the liquidator.³⁸⁴

The intended mechanism for the floating charge’s attachment under the 1961 Act was therefore that the charge was deemed a fixed security only for the purpose of giving effect and priority to a charge within the chargor’s liquidation.³⁸⁵ There was no suggestion that the charge, upon attachment, would take on the characteristics of particular rights in security over relevant types of property, as was first suggested in *Forth & Clyde* when the court was interpreting provisions in the 1972 Act.³⁸⁶

³⁸¹ Ibid.

³⁸² Ibid.

³⁸³ This seems to be supported by NRS AD63/481/2 – Revised Note (HL) on Companies (Floating Charges) (Scotland) Bill, Notes on Clauses, Clause 1(2).

³⁸⁴ NRS AD63/481/1 – Memorandum on Companies (Floating Charges) (Scotland) Bill by the Royal Faculty of Procurators in Glasgow, para 3, enclosed with Letter from Royal Faculty of Procurators in Glasgow, to the Secretary, Lord Advocate’s Department, dated 28 April 1961.

³⁸⁵ See also NRS HH41/1434 – letter from JH Gibson, Lord Advocate’s Chambers, to G Black, Registers of Scotland, dated 13 January 1961 – in which Gibson noted that it was “only in the distribution of a company’s assets by a liquidator that a floating charge has effective operation”.

³⁸⁶ See further below.

(2) Later Legislation

The phraseology used for the receivership attachment provisions, within the 1972 Act,³⁸⁷ and now the 1986 Act,³⁸⁸ was, and is, in slightly different terms to the equivalent provisions for attachment upon liquidation in the 1961 Act, the 1972 Act³⁸⁹ and now the 1985 Act. The current wording of the 1985 Act, s 463(2), is:

The provisions of Part IV of the Insolvency Act (except section 185) have effect in relation to a floating charge, subject to subsection (1), as if the charge were a fixed security over the property to which it has attached in respect of the principal of the debt or obligation to which it relates and any interest due or to become due thereon.

By contrast, the effect of attachment in receivership or administration is not expressly restricted to Part IV of the 1986 Act or any equivalent set of statutory provisions. The present receivership provisions merely state that “attachment has effect as if the charge was a fixed security over the property to which it has attached”, without reference to the statutory hypothesis applying within a particular limited context. Almost identical wording is used for the attachment effect in administration.³⁹⁰ As a result, it is arguable that attachment upon liquidation has a different effect than attachment upon receivership or in an administration. But it can also be contended that attachment and its consequences in receivership and administration are inherently limited by the fact that the charge is only enforceable in these particular contexts (and in liquidation). In other words, the floating charge is only a fixed security for the statutory regimes of administration and receivership and for the law interacting with those regimes.

³⁸⁷ Ss 13(7) and 14(7).

³⁸⁸ S 53(7). S 54(6) is in the same terms except “were” is used in place of “was”.

³⁸⁹ S 1(2).

³⁹⁰ 1986 Act, Sch B1, para 115(4): “as if the charge is a fixed security over the property”.

B. A STATUTORY HYPOTHESIS

Wilson describes the floating charge attachment mechanism as a “statutory hypothesis”.³⁹¹ What this means is that the legislation causes the floating charge to act and be treated like a fixed security. But what is a fixed security here and to what extent does the floating charge take on characteristics of such a security?

(1) Competing Theories of Attachment

It is suggested by Wilson that the alternative theories of attachment correspond to two philosophies of receivership.³⁹² The first philosophy restricts the effect of receivership to the relationship between the chargeholder and the company. It considers there to be little difference between the company and the receiver, and is supported by the receiver’s agent status and the absence of vesting of property in the receiver. This aligns with viewing the deemed fixed security, when the floating charge attaches, as a general *sui generis* security “which merely gives a preference in the winding-up of the company”.³⁹³ As noted above, there is an especially strong case for such an analysis in relation to attachment in a company’s liquidation.

The second philosophy views attachment in a similar way to sequestration, and there is thus a clear division between the company and the receiver, and Wilson claims this is statutorily supported by the floating charge’s priority over some diligence.³⁹⁴ The basis for this assertion regarding diligence is unclear but is presumably rooted in the highly criticised interpretation of “effectually executed diligence” in *Lord Advocate v RBS*.³⁹⁵ Given that this authority was recently overturned in *MacMillan*, and bare diligence³⁹⁶ now constitutes “effectually executed diligence” (if not rendered ineffective by its proximity to liquidation), and thus ranks ahead of

³⁹¹ He seems to first use this description in WAW, “The Receiver and Book Debts” 1982 SLT (News) 129 at 129 and WA Wilson, *The Law of Scotland Relating to Debt* (1982), 142.

³⁹² WA Wilson, “The Nature of Receivership” 1984 SLT (News) 105 at 105.

³⁹³ Ibid.

³⁹⁴ Ibid.

³⁹⁵ See Wortley, “Squaring the Circle”.

³⁹⁶ Ie where diligence has been executed but the process has not been completed, such as where there is arrestment without furthcoming or where property has been attached (in the diligence sense) but not yet sold.

the charge, the legal basis for the second philosophy is undermined. In any event, this philosophy apparently causes the attaching charge to take on the characteristics of the existing form of voluntary security for the property in question. Although Wilson’s discussion is limited to the law of receivers, the attachment mechanism applies in liquidation and administration too and therefore it must also be considered within these contexts.

(2) The Integrated Approach

In Wilson’s view, the “more natural approach” (at least in receivership) is for the floating charge to attach like the appropriate fixed security for each type of property.³⁹⁷ This can be described as the “integrated approach”, as it embeds the floating charge’s operation within existing Scots law. The approach means it attaches to heritable property as if it is a standard security; to corporeal moveables as if it is a pledge; and to incorporeal property as if it is an assignation in security. These security rights have different natures. The consensus position is that assignation in security involves the transfer of a right, while a pledge is a subordinate real right founded upon possession and the standard security is a non-possessory subordinate real right established by registration.

In *Telford*, a case decided before the introduction of receivership, the First Division considered that a floating charge was a real right in security upon attachment.³⁹⁸ They did not, however, ascribe a particular security right to the attachment of the floating charge. It was only after the arrival of receivership that the integrated approach was judicially adopted by the First Division in *Forth & Clyde*. A book debt had been arrested following the appointment of a receiver. The court held that upon attachment the book debt was deemed assigned to the chargeholder with intimation to the debtor. This was because assignation in security with intimation was the only “effective security” for such property. Consequently, the arrestment by the *chargor’s* creditor was invalid. (If the property was not considered to be assigned to the chargeholder, in the competition with the arrester, the charge should simply have ranked ahead). According to Lord President Emslie, the chargeholder was intended to have “the advantages” which the holder of the relevant “effective security” would have under the law.³⁹⁹ The court in *Forth & Clyde*

³⁹⁷ WAW (n 391) at 129.

³⁹⁸ Especially per LP Clyde at 193ff.

³⁹⁹ *Forth & Clyde* at 11.

recognised there was actually no transfer, but the extent of the fiction is not obvious. On the basis of the Lord President's suggestion that, despite the deemed assignation in security and intimation, the company "retains the title to demand payment of the debt but no longer for its own behoof", it is apparent that the integrated approach does not (in the court's view) circumvent the fact that the receiver is only agent for the company, as regards its property.⁴⁰⁰ By not applying all of the characteristics of the relevant security, the approach taken by the court is a restricted integrated approach.

(3) The *Sui Generis* Approach

An alternative interpretation of the statutory hypothesis is that, upon attachment, the floating charge is a *sui generis* security. This is an argument outlined by Reed⁴⁰¹ and also discussed by Wilson (see above). Although Reed suggests that the approach adopted in *Forth & Clyde* represents a *sui generis* position regarding attachment in receivership,⁴⁰² the *sui generis* approach is more helpfully categorised as an approach which does not tie the operation of the floating charge to specific characteristics of particular existing security rights in Scots law (unlike in *Forth & Clyde*). Instead, attachment under this interpretation causes the floating charge to operate like a "fixed security" in a generalised sense. The term "fixed security" means "... any security... which on the winding up of the company in Scotland would be treated as an effective security over that property..."⁴⁰³ Thus, upon attachment, the floating charge functions like a generic security that is effective over property in a winding up, supplemented by the specific rules relating to floating charges.

An argument along the above-noted lines was put forward by the respondents (reclaimers) in *Forth & Clyde*. It was argued that "the effect of the floating charge is to create a new species

⁴⁰⁰ Ibid. GL Gretton, "The Floating Charge in Scotland" 1984 JBL 344 at 344f queries the meaning of the Lord President's statement and its compatibility with the law of incorporeal moveable property. And see also *McPhail v Lothian Regional Council* 1981 SC 119 and *Taylor Petr* 1981 SC 408 which consider the related issue of whether a receiver can recover book debts by raising an action using his own name. They reach different conclusions on the point. And see also *Myles J Callaghan* (n 355).

⁴⁰¹ See RJ Reed, "Aspects of the Law of Receivers in Scotland: II The Effect of Receivership" 1983 SLT (News) 237; RJ Reed, "Aspects of the Law of Receivers in Scotland: III The Receiver's Duty of Care" 1983 SLT (News) 261.

⁴⁰² At 265f. This is true insofar as the deemed assignation in security does not involve all of the effects of that form of security.

⁴⁰³ See 1985 Act, s 486(1), and 1986 Act, s 70(1).

of security in a general form, the effect of which is not determined by the kind of security appropriate to each type of property under the general law".⁴⁰⁴ This approach did not find favour with the court. As well as *Forth & Clyde*, the Inner House in *Sharp* specified that upon attachment a floating charge operates like a recorded standard security as regards heritable property,⁴⁰⁵ and despite the overall decision in the House of Lords, they did not depart from the Inner House on this point.⁴⁰⁶

C. A SECURITY *SUI GENERIS*?

Despite the significant support for some form of the integrated approach, there are powerful, even compelling, arguments against it and in favour of the *sui generis* position. Firstly, as noted above, the intention of those involved with the 1961 Act was for the floating charge to be a statutory insolvency preference and for it to only operate as a fixed security for statutorily limited purposes.

Secondly, the current legislative provisions for attachment upon liquidation clearly limit the attachment effect to purposes outlined by statute. The 1985 Act, s 463(2), provides that the floating charge attaches as if it were a fixed security for the purposes of Part IV of the 1986 Act, except s 185.⁴⁰⁷ This latter section applies certain sequestration provisions in the 2016 Act to liquidation.⁴⁰⁸ These modified provisions outline the effect of diligence in liquidation and provide rules regarding the management and realisation of property in that process, including restrictions upon a liquidator's ability to sell heritable property where he is subject to higher-ranking secured creditors.⁴⁰⁹ The non-application of the latter to an attaching charge further reinforces the view that a chargeholder cannot itself enforce, and does not have the power to stop a liquidator from realising charged heritable property. There is noticeable consistency too between the attachment effect in liquidation and the fact that the express meaning of fixed security is a security over property effective in such a process. However, the

⁴⁰⁴ *Forth & Clyde* at 6.

⁴⁰⁵ 1995 SC 455 especially per Lord Coulsfield at 488.

⁴⁰⁶ *Sharp* per Lord Jauncey at 70 and Lord Clyde at 79.

⁴⁰⁷ 2007 Act, s 45, adopts the same approach as the current provisions for the effect of attachment in liquidation. However, it is unlikely that s 45 will ever now be introduced.

⁴⁰⁸ 1986 Act, s 185(1), applying 2016 Act, ss 23A(3)-(10), 24, and 109(6)-(7), (10)-(11).

⁴⁰⁹ 2016 Act, s 109(7).

explicit limitation of the statutory hypothesis in liquidation contrasts with the provisions for receivership and administration. But if there is to be a single attachment mechanism for floating charges, then it is much easier to read in limitations to the receivership and administration provisions than to ignore the express restrictions for liquidation. Within the 1986 Act, the references to the floating charge operating as if it is a fixed security actually appear to have little meaning because, throughout the Act, there is a continuing distinction between fixed and floating charges, even after floating charges attach.⁴¹⁰ Yet the provisions serve to emphasise the floating charge's status as an effective security over property in liquidation, as well as in receivership and administration,⁴¹¹ and this status can be used to answer any unforeseen points, where distinguishing the floating charge from the claims of unsecured creditors may be important.⁴¹²

Thirdly, the *sui generis* approach is consistent with the floating charge's nature. With reference to the creation of the charge and its attachment, the legislation does not make distinctions based upon the types of property affected. It would therefore be appropriate for the floating charge to attach to property in a uniform and non-fragmentary way, albeit that the charge must interact with specific regimes for particular types of property. This would mean the charge should be considered a generic fixed security for each item of property attached, the consequences of which are provided by the floating charge legislation and other legislation relevant to the charge's enforcement.

Fourthly, the considerable uncertainties about the content and extent of the integrated approach raise doubts about its credibility. In *Forth & Clyde* the court decided that a deemed assignation in security to the chargeholder rendered a post-attachment diligence by the chargor's creditor invalid. However, the effect is not a full (fictional) divestment of the chargor, as the chargeholder does not obtain title to sue and is limited by the enforcement mechanism of the charge.⁴¹³ The receiver, acting as a representative of the chargor, can deal with the property, raise actions and receive proceeds, while the purported "assignee" cannot

⁴¹⁰ For example, in relation to distribution in receivership (s 60) and administration (Sch B1, para 116).

⁴¹¹ For ranking purposes and otherwise.

⁴¹² As was the case in *Telford*, which dealt with a chargeholder's entitlement to interest on the principal debt between the date of liquidation and the repayment of the principal.

⁴¹³ And see GL Gretton, "Receivers and Arresters" 1984 SLT (News) 177 at 178f.

do any of these things.⁴¹⁴ There are also unclear implications for issues like (so-called) “set-off”.⁴¹⁵ A further point of uncertainty is whether a post-attachment arrestment is only ineffective against a chargeholder and a receiver, or whether it would also be ineffective more widely, such as in liquidation.⁴¹⁶ In addition, as Reed queries, does the assignment in security effect mean that once the debt to the chargeholder is satisfied there is a deemed intimated retrocession to the chargor?⁴¹⁷ And if a claim is non-assignable, does the attachment mechanism fail and the property becomes unsecured?⁴¹⁸ A further difficulty arises where there are multiple charges. Incorporeal property is unititular, so it cannot be assigned to more than one party, which may mean that only one charge can attach the property. This is especially problematic if a lower-ranking charge attaches before a higher-ranking one. By contrast, a *sui generis* approach would more clearly enable multiple charges to rank over the same property.

Moving now to other property types, the pledge of a corporeal moveable requires possession, which cannot be split between different parties. So, if the chargeholder is a deemed pledgee, does this mean it is considered to have possession, and, if so, how does this impact upon a pledgee (or other party) who actually does have possession? As Gretton notes, there is a certain absurdity in providing that the charge operates like particular deemed fixed securities on attachment.⁴¹⁹ For example, heritable securities, unlike floating charges, are registered in the Land Register, and various consequences flow from this, and floating charges do not confer the enforcement rights available to standard security holders. Also, how does one explain the disparity between the ranking rules for floating charges and those for the fixed securities that a charge is deemed to become? These issues (and others) are largely avoided by using the *sui generis* approach, which more readily confines and clarifies the attachment mechanism through the ambit of statutory provisions.

Fifthly, the integrated approach appears dependent upon there only being one fixed security for each type of property but this is not the case for all forms of property. For instance, when

⁴¹⁴ See the argument along these lines by the respondents (reclaimers) in *Forth & Clyde* at 6f.

⁴¹⁵ See eg St Clair and Drummond Young, *Corporate Insolvency*, paras 17-10ff; Wilson, *Debt*, para 9.19.

⁴¹⁶ Also uncertain is if it would become effective if the company exited receivership, or if a new diligence would instead need to be executed.

⁴¹⁷ Reed, “Receivers II” (n 401) at 239.

⁴¹⁸ See also *ibid.* And see 234ff below.

⁴¹⁹ Gretton (2003) (n 8) at 321f.

the floating charge was introduced into Scots law, there was more than one type of heritable security available. And the principal forms of heritable security, the bond and disposition in security and the *ex facie* absolute disposition in security qualified by back letter, had different natures. Yet both of these were fixed securities under the 1961 Act.⁴²⁰ Consequently, what form would the charge's attachment to heritable property have taken? And, as Reed asks, did the charge's nature for heritable property change upon the introduction of the standard security?⁴²¹ It is notable that the integrated approach was first proposed and judicially adopted a number of years after the standard security became the only security grantable over heritable property; at which point, some of the difficulties of this approach were obscured. However, for certain property there continue to be multiple voluntary security rights available. For instance, ships and aircraft can be pledged or "mortgaged", and a ship can also, in theory, be the subject of a bond of bottomry.⁴²² Which form(s) would an attaching charge take, and why? And if a new form of security over moveable property is introduced (as proposed by the SLC) will that affect the deemed effect of the charge's attachment over corporeal moveables and particular incorporeal moveables more widely? Even under the current law for security over incorporeal property, there are certain distinctions between assignation expressly in security and assignation *ex facie* absolute.⁴²³ Yet, despite counsel for the respondents (reclaimers) in *Forth & Clyde* raising this, the court ignored the point.⁴²⁴

All of the above suggests that the *sui generis* approach is the preferable one. It may seem contradictory to propose that the property attachable by the floating charge ought to be determined by the underlying Scots law while also arguing that the attachment mechanism should not conform directly to that law. But the different analyses are justified. The starting point of the former necessarily involves examining property law and legal relationships external to the floating charge, and the approach taken is more amenable, in doctrinal terms, than adopting English equitable concepts. Meanwhile, an approach to the attachment mechanism that does not involve the charge transforming into particular existing security rights reflects the charge's singular nature and still fits it suitably into the wider law. These

⁴²⁰ See 195ff.

⁴²¹ Reed, "Receivers II" (n 401) at 239.

⁴²² See eg Sim, "Rights in Security", paras 26ff.

⁴²³ See 240ff.

⁴²⁴ *Forth & Clyde* at 7. Counsel also argued that an intimated assignation is not a security over property but a transfer of a claim against a debtor. And see n 1028 below.

analyses are consistent in perceiving the floating charge as a *sui generis* creation operating within the environment of Scots property law.

D. THE NATURE OF THE ATTACHED CHARGE

The particular effect of the attachment mechanism is also closely related to questions about the floating charge's nature. Obviously, the closer the attached charge is to particular types of real rights in security in Scots law, the more appropriate it is to describe it as a real right. Indeed, based upon the prevailing deemed effect of the charge, commentators state that it becomes a real right upon attachment.⁴²⁵ But it has also been pointed out that there are fundamental differences between the post-attachment charge and the particular security rights it is considered to mirror, such as the absence of the remedies available to the fixed security creditor.⁴²⁶ If, instead, the effect of attaching as a fixed security is limited to certain purposes, such as ranking in liquidation, receivership and administration, then the notion of the floating charge as a real right is more precarious. This is particularly true when we consider the limitations on a charge's enforcement, as will be outlined in the next chapter. If the charge is a *sui generis* security upon attachment, it is easier to accept that the floating charge is, or was intended to be, a preference right, with some real effects, or a preference/real right hybrid,⁴²⁷ or a preferred personal right,⁴²⁸ rather than a real right in the traditional sense.⁴²⁹

When attachment takes place, there is necessarily some fragmentation of the floating charge, as it applies to individual items of property affected by different regimes. Nevertheless, the

⁴²⁵ See eg Reid, *Property*, para 5 and n 5; Styles, "Two Types of Floating Charge" at 240. And see eg *Telford*. However, the discussion in that case revolves around the status of the floating charge within liquidation, where it is to have the effect of a fixed security. Indeed, at certain points it is acknowledged that a charge only attaches "as if" it is a fixed security, ie it is an equivalent to this rather than actually becoming a fixed security – see eg per Lord Guthrie at 197f and per Lord Cameron at 205f.

⁴²⁶ Paisley, *Land Law*, paras 2.6 and 11.27, cites the attached charge as an addition to the *numerus clausus* of real rights but points to the limited fixed security effect of the charge (eg regarding ranking) and the absence of enforcement remedies that a fixed security creditor has.

⁴²⁷ Gretton, "Concept of Security" at 146, suggests that floating charges "lie half-way between traditional security rights and rights of preference".

⁴²⁸ See Scottish Law Commission, *Report on Diligence on the Dependence and Admiralty Arrestments* (No 164) (1998), paras 9.7ff. The Report states that "protected personal rights" entitle a personal creditor to exclude property from the debtor's sequestration while "preferred personal rights" do not exclude affected property from such a process but do give a preference.

⁴²⁹ This is discussed further at 156ff.

charge itself seems to remain a unit which can only be transferred as a whole. For example, it probably would not be possible to transfer the attached charge over heritable property separately from the remainder of the charge. The attachment and enforcement provisions are apparently constructed on the basis of the charge remaining a unified whole, and there might be significant complications if there were multiple chargeholders stemming from one original charge.⁴³⁰ This is consistent with viewing the floating charge's relationship with property as unitary, and seems to add further credence to the view that the attachment mechanism is *sui generis*.⁴³¹

One issue that emerges from the charge's unified status is whether it should be characterised as moveable or heritable property.⁴³² There would be considerable complications if its nature corresponded proportionally to the types of property charged. The property would continue to change and fluctuate making calculations for the relevant apportionments fiendishly difficult. It would be simpler, but arbitrary, to just regard the charge as moveable, and for the proceeds received from a liquidator or equivalent to be treated as such.⁴³³

In any event, the particular property attached does impact upon whether the charge is viewed as a real right, if certain analyses of real rights and property are adopted. Some would contend that it is not possible for there to be a real right where the (immediate or ultimate) object is not corporeal property. And if "real right" is inappropriate in this context, then the charge might have a divided nature upon attachment dependent upon the property attached; part(s) real right, part(s) limited personal right.⁴³⁴

⁴³⁰ Eg the receivership distribution provisions (1986 Act, s 60) refer to payment of proceeds to the chargeholder by virtue of which the receiver was appointed, suggesting a singular floating charge and one receiver (or joint receivers) deriving therefrom. There would also be disjunctiveness with the fact that one charge was created, and the charges register would only show a single charge.

⁴³¹ If instead it attached like specific forms of security, the charge would be more piecemeal and there would be a greater likelihood of it being considered severable.

⁴³² Given that chargeholders are almost invariably non-natural persons, the distinction is of limited practical importance.

⁴³³ The SLC, *Consultative Memorandum No 72: Floating Charges and Receivers* (1986), noted that it was unclear whether the debt secured by a floating charge was heritable or moveable (para 2.91), and also mentioned the uncertainty regarding which diligence ought to be used (para 2.92). They recommended legislative provision to classify the rights under a debt secured by a floating charge as moveable property (para 2.92). Cf Titles to Land Consolidation (Scotland) Act 1868, s 117.

⁴³⁴ This would be consistent with the arguments made in *Gretton* (n 339).

CHAPTER 6

ENFORCEMENT OF THE FLOATING CHARGE

A.	INTRODUCTION	119
B.	SELF-ENFORCEMENT?	120
C.	ENFORCEMENT IN COMPETITION WITH A FIXED SECURITY HOLDER	123
	(1) Higher-Ranking Fixed Security Holder	123
	(2) Lower-Ranking Fixed Security Holder	131
D.	LIQUIDATION	134
	(1) Property Limitations	135
	(2) Removal of Property from Patrimony	137
E.	RECEIVERSHIP	139
	(1) The Receiver and Property	139
	(2) Uniformity with Liquidation?	144
	(3) Receivership and the Enforcement of Diligence	149
F.	ADMINISTRATION	154
G.	A REAL RIGHT?	156
	(1) Real Right Indicators and Patrimonial Limitations	156
	(2) Real Right or Preference Right?	159

A. INTRODUCTION

This thesis seeks to place the floating charge in the wider context of Scots property law. However, understanding the nature and operation of the charge also necessitates an analysis of the charge, and its relationship with attached property, within the law of insolvency. The present chapter will do this by specifically focusing on the charge's enforcement. Here, enforcement means a process by which the charged property is used to satisfy the debt due to the chargeholder.⁴³⁵ Although attachment is a necessary condition for enforcement of a

⁴³⁵ It is recognised that this does not necessarily apply to administrations, but enforcement here includes administrations in which the floating charge attaches and the administrator is making distributions.

floating charge, as it gives the chargeholder the right to receive proceeds for satisfaction, liquidation, receivership and administration are the means of enforcement.⁴³⁶ Nevertheless, attachment and enforcement are intertwined and there is more immediacy between the real effect of the charge, upon attachment, and its enforcement, than there is for (other) real security rights.

Consideration of the floating charge in Scots law often involves discussion of aspects of the enforcement regimes, especially receivership.⁴³⁷ However, minimal attention has been paid to the patrimonial, limiting effect of the processes on property potentially subject to the charge. It is often assumed that, whenever property is attached by a floating charge, the charge can be successfully enforced against such property.⁴³⁸ Instead, there is the possibility that the enforcement methods render a floating charge ineffective even for attached property. This ineffectiveness is more extreme than the charge attaching but being subject to higher-ranking competing interests, which may or may not exhaust the property charged. It means that the floating charge cannot be exercised over the property, irrespective of ranking position. The fact that there are different regimes to enforce a floating charge, with their own features, also raises the question as to whether there is one law of floating charges, with certain deviations only regarding enforcement, or whether the distinct regimes mean there are actually multiple laws of floating charges, corresponding to the various enforcement methods.

B. SELF-ENFORCEMENT?

Here, “self-enforcement” consists of enforcement by the chargeholder without the necessity of intervention by a third party. From a practical perspective, it is more sensible for the law to require a non-creditor third party, such as a liquidator, receiver or administrator, to identify, control and realise the (potentially) wide range of property that is subject to a floating charge

⁴³⁶ Cf SC Styles, “Rights in Security” in ADM Forte (ed), *Scots Commercial Law* (1997), 196, who describes attachment as the process of enforcing the floating charge.

⁴³⁷ As the only floating charge-specific, and formerly the most common, enforcement regime. Indeed, the only book specifically on floating charges in Scots law focuses on receivership – *Greene and Fletcher: Receivership*.

⁴³⁸ Eg in *Sharp* the argumentation revolved around attachment and it was assumed that the receiver would automatically prevail if the property was attached. In the commentary on *Sharp* there is also an absence of consideration of enforcement as a separate issue. A connected view of attachment and enforcement is also highlighted (and partially negated) by the 2012 Act, s 93, which provides that a good faith acquirer is not affected by a floating charge granted by the disponent’s predecessor in title.

(and other securities). It is unlike the usual secured creditor scenario in which a particular item is specifically identified as secured, through, for example, registration or delivery, which facilitates enforcement by one creditor. Nevertheless, English law allows for a range of enforcement methods following crystallisation of a floating charge, including self-enforcement.⁴³⁹ The English floating charge seems able to offer a closer enforcement relationship between the chargeholder and the property charged than the Scottish version.⁴⁴⁰ But are there any circumstances in which self-enforcement by a chargeholder would be permitted in Scots law?

In *Libertas-Kommerz* the issue of self-enforcement was raised. Counsel for the liquidator argued that, because a floating charge becomes a fixed security over property upon liquidation, the property would not vest in the liquidator and the chargeholder would have to realise the property.⁴⁴¹ This seems to ignore the fact that even non-encumbered property does not vest in the liquidator and that the liquidator himself can, subject to qualifications, deal with property subject to a security.⁴⁴² Nevertheless, in support of the argument, reference was made to *Telford*, in which the Inner House had emphasised that the floating charge becomes a real right upon attachment (in liquidation). Lord Kincaid, in *Libertas-Kommerz*, rejected the submission and stated that *Telford* did not mean the chargeholder would have to realise the security itself.⁴⁴³ He also suggested that there would have been difficulties doing this before receivership was introduced,⁴⁴⁴ presumably due to the absence of an enforcement mechanism except for realisation and distribution by the liquidator. Certainly, the framing and intention of the 1961 Act was for the charge to be given effect through a liquidator and it is hard to read *Telford*, and the limited real right effect of a charge outlined in that case, as changing anything in this regard. In fact, it was suggested in the case that enforcement at that time would, in practice, need to be carried out by the liquidator giving effect to the charge.⁴⁴⁵ In no Scots law case has it been held that a chargeholder can self-enforce and this is in line with the original intended operation of the charge, as outlined in the previous chapter. The issue of self-

⁴³⁹ See eg Goode, *Legal Problems*, para 4-65.

⁴⁴⁰ For the English position, see eg Goode, *Legal Problems*, paras 4-42ff.

⁴⁴¹ At 204.

⁴⁴² See 134ff below.

⁴⁴³ At 204.

⁴⁴⁴ This implies that he viewed enforcement by the chargeholder in a wide sense to include receivership.

⁴⁴⁵ See eg per Lord Guthrie at 198 and per Lord Cameron at 210.

enforcement has not been discussed in detail by commentators, which can be read as an endorsement of the view that self-enforcement is not possible.⁴⁴⁶

It could be argued that an integrated approach to the statutory hypothesis facilitates self-enforcement. If the charge attaches as if it is a fixed security, could this extend to the enforcement methods available to the holders of corresponding fixed securities? This view is, however, undermined by the absence of specific statutory provisions for self-enforcement. The recognised enforcement methods are expressly constructed in the legislation, and the floating charge is, of course, a statutory device. In liquidation, the charge attaches as if it were a fixed security expressly for the purposes of that process, and the attachment effect in receivership and administration occurs within those enforcement contexts, which provide for distribution to the chargeholder and others, suggesting that the chargeholder cannot proceed separately.⁴⁴⁷

It would be problematic if the statutory hypothesis allowed for enforcement as if the charge were a particular fixed security. For example, the provisions of the 1970 Act are clearly not designed for a floating charge to take on characteristics of the standard security, regarding enforcement or otherwise. And there are no direct translation provisions which fit the charge into the contents of the 1970 Act.⁴⁴⁸ The various forms for notices of enforcement even refer to a standard security which has been registered or recorded in the Land Register or Register of Sasines;⁴⁴⁹ and floating charges are not so registered or recorded. There would also be problems for enforcement as regards other types of property if the charge attached like the corresponding fixed securities.⁴⁵⁰ Professor Paisley rightly notes that the statutory hypothesis “cannot be taken too far”: as although the chargeholder has certain ranking rights like a fixed

⁴⁴⁶ However, it is, for example, stated in *Palmer's Company Insolvency*, para 481, that a chargeholder may rank as a secured creditor in liquidation “instead of pursuing his rights under the charge”. Yet the alternative enforcement suggested is almost certainly the appointment of a receiver rather than actual self-enforcement.

⁴⁴⁷ This is also a logical consequence of the fact that attachment only takes place in these processes.

⁴⁴⁸ Cf Abolition of Feudal Tenure etc (Scotland) Act 2000, s 69, involving pre-1970 forms of heritable security, which by virtue of their content and registration against particular property in the Register of Sasines, more closely correspond to standard securities than the floating charge does.

⁴⁴⁹ See the notices in Sch 6. And see ss 19ff.

⁴⁵⁰ Eg for corporeal moveable property and pledge, the absence of possession by the chargeholder presents difficulties for realising the property, and for incorporeal moveable property, the non-existence of an assignation to the chargeholder and related intimation undermines enforcement against a claim debtor.

security from attachment, the attachment effect does not extend to enforcement mechanisms.⁴⁵¹

C. ENFORCEMENT IN COMPETITION WITH A FIXED SECURITY HOLDER

(1) Higher-Ranking Fixed Security Holder

A more difficult question is whether, and how, an attached floating charge can be enforced where a fixed security holder sells property for realisation purposes.⁴⁵² For example, A Ltd grants a standard security to B Bank, which is registered in the Land Register, and then later grants a floating charge to C Bank. B Bank's standard security ranks ahead of C Bank's floating charge.⁴⁵³ A Ltd defaults on its repayments to B Bank and C Bank. B Bank seeks to enforce using the standard security.

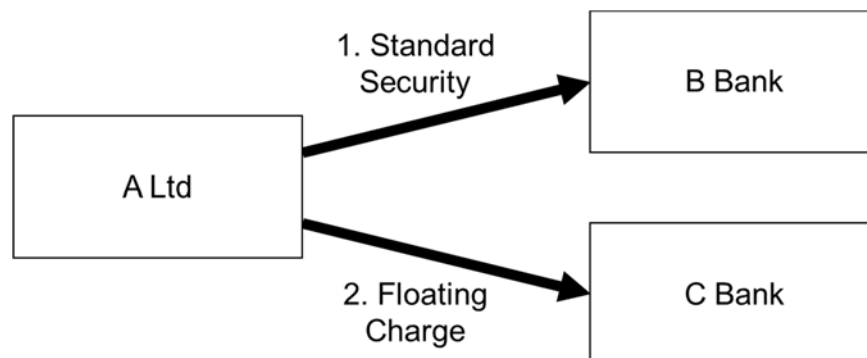

As mentioned in a previous chapter, C Bank will have no ranking entitlement unless attachment takes place. B Bank would simply distribute to any other secured creditors

⁴⁵¹ Paisley, *Land Law*, para 11.27. Paisley states, however, that the only means of enforcement is receivership. He may here be referring to receivership as the only floating charge-specific enforcement mechanism.

⁴⁵² The focus of this section is *sale* by a fixed security holder. Where other remedies are used, see eg 1970 Act, Sch 3, para 10(3)-(7), there are additional ranking and enforcement problems.

⁴⁵³ Due to 1985 Act, s 464(4)(a). This would also be the case, irrespective of creation dates, if a real ranking agreement provided that C Bank's charge was to rank behind B Bank's standard security (1985 Act, s 464(1)(b)). The following discussion could, therefore, also be relevant in that context. However, an agreement may provide precisely how realisation and distribution is to take place.

according to their priorities, with any residue to be paid to A Ltd.⁴⁵⁴ C Bank might benefit by a subsequent attachment to such residuary proceeds held by A Ltd, or to A Ltd's right to receive them.⁴⁵⁵

Yet, to protect its interest, C Bank may take enforcement steps that can lead to its charge attaching. If C Bank's charge does attach, how can it receive a ranking entitlement if B Bank enforces? As C Bank's floating charge can attach within: (i) administration; (ii) receivership; and (iii) liquidation, the potential for enforcement by B Bank during these processes will be examined in turn. This will be followed by consideration of whether C Bank has a ranking priority in the property and how this can be claimed, in spite of enforcement by B Bank.

Administration causes a moratorium on steps to "enforce security over the company's property", except with the consent of the administrator or the court's permission.⁴⁵⁶ Therefore, B Bank could not usually proceed with enforcement of the standard security, and if C Bank's charge attaches, the administrator will distribute in line with the ranking priorities.⁴⁵⁷ Were a fixed security holder to apply for permission to enforce, either before or after the attachment of the charge, case-law-generated guidelines assist with determining whether the administrator or court ought to grant or refuse.⁴⁵⁸ It is suggested that if the circumstances may justify granting permission, conditions should be imposed requiring the fixed security holder to transfer all surplus proceeds to the administrator, rather than directly to any other secured creditors (of any type), so as not to prejudice the chargeholder or other parties such as preferential creditors.⁴⁵⁹ There is significant doubt in this context regarding the competency of a court departing from the statutory distribution regime in s 27(1) of the 1970 Act when laying down conditions for enforcement. However, if a court is allowed to order a secured creditor to transfer all surplus proceeds to a liquidator (see below), despite the wording of s 27(1), then the provisions may be flexible enough to enable an administrator to impose equivalent conditions when permitting a secured creditor to enforce. If the fixed security

⁴⁵⁴ See the order of priority of distribution in 1970 Act, s 27(1).

⁴⁵⁵ If C Bank's charge attached later it would not affect the transferred heritable property. It would also give no right to the proceeds unless A Ltd had such right in or to the proceeds.

⁴⁵⁶ 1986 Act, Sch B1, para 43(2).

⁴⁵⁷ Ibid, paras 115 and 116.

⁴⁵⁸ See *Re Atlantic Computer Systems Plc* [1992] Ch 505 per Nicholls LJ at 541ff; *Scottish Exhibition Centre Ltd v Mirestop Ltd* 1993 SLT 1034; and see the discussion at St Clair and Drummond Young, *Corporate Insolvency*, paras 5-66f.

⁴⁵⁹ 1986 Act, Sch B1, para 43(7), allows a court to "impose a condition on or a requirement in connection with the transaction". The statutory provisions for administration could justify overriding the distribution order requirements of the 1970 Act, s 27(1).

holder has already received proceeds of sale by the time the administrator is appointed, then it seems that permission would not be required. The moratorium will not affect the distribution of proceeds, as this is a post-enforcement step and the property does not belong to the company in administration.

Next, we must consider the position where the appointment of a receiver has caused C Bank's charge to attach. If so, the receiver will often realise and distribute to creditors in the statutory order of priority; B Bank will therefore receive payment before C Bank.⁴⁶⁰ The receiver can seek the court's permission to sell property if a prior-ranking secured creditor, like B Bank, does not consent.⁴⁶¹ But this application will only be granted if the court "is satisfied that the sale or disposal would be likely to provide a more advantageous realisation of the company's assets than would otherwise be effected".⁴⁶² A fixed security holder may then decide to defer to enforcement by the receiver and await proceeds. However, the powers of a receiver are subject to the rights of those with prior ranking fixed securities (and floating charges)⁴⁶³ and thus it seems that a higher-ranking fixed security holder can enforce against property despite the existence of a receiver.⁴⁶⁴ The potential implications of this are considered below.

Finally, what is the position for liquidation? Where there is a fixed security over heritable property, which is preferred to the liquidator, like B Bank's standard security, the liquidator can only sell the property if he can obtain a high enough price to discharge the preferred fixed security or if he has the fixed security holder's permission.⁴⁶⁵ A fixed security holder, for any property type, has a number of options when its debtor goes into liquidation: to realise the security separately from the liquidation;⁴⁶⁶ to realise and then claim for any deficit in the

⁴⁶⁰ 1986 Act, s 60(1).

⁴⁶¹ *Ibid*, s 61(1)(a).

⁴⁶² *Ibid*, s 61(3). Perhaps this test would also factor into the court's thinking if an application were made in administration for sale of secured subjects, where there is a moratorium (see above). Given that a standard security holder is under a duty to "take all reasonable steps to ensure that the price at which all or any of the subjects sold is the best that can be reasonably obtained" (1970 Act, s 25), it is unclear how realisation by a receiver could be "more advantageous". The same is true of other secured creditors who are under a general duty to maximise the price for which the property is sold.

⁴⁶³ 1986 Act, s 55(3)(b).

⁴⁶⁴ See eg *Imperial Hotel (Aberdeen) Ltd v Vaux Breweries Ltd* 1978 SC 86, where a chargeholder also had a standard security and enforced using the latter after the appointment of a receiver. See also *Greene and Fletcher: Receivership*, para 2.30.

⁴⁶⁵ 1986 Act, s 185(1)(b), which applies 2016 Act, s 109(7). 1985 Act, s 463(2), provides that a floating charge will not be a fixed security for this purpose.

⁴⁶⁶ The liquidation distribution rules do not affect the right of a secured creditor who ranks ahead of the liquidator: 1986 Rules, r 4.66(6)(a).

liquidation;⁴⁶⁷ to claim in the liquidation after deducting the value of the security;⁴⁶⁸ or to surrender the security and claim for the total debt in the liquidation.⁴⁶⁹ From 12 weeks after the commencement of winding up, the liquidator may require a fixed security holder to discharge the security or convey or assign it to him upon payment of its value, and the fixed security holder can claim for any balance.⁴⁷⁰ In many cases, however, a fixed security holder will decide to enforce outside the formal liquidation process. This is also apparently allowable where there is a floating charge, as the charge's attachment is subject to the rights of those with prior-ranking fixed securities.⁴⁷¹ Thus, B Bank could enforce despite the commencement of liquidation having caused C Bank's charge to attach.

If B Bank were to enforce, during one of the above-noted processes,⁴⁷² would C Bank have an entitlement to the property or its proceeds? And, if so, how? The law is not certain on these matters but there are various possibilities that must be considered. The following diagram assists:

⁴⁶⁷ Ibid, r 4.16G(3).

⁴⁶⁸ Ibid, r 4.16G(1)(a).

⁴⁶⁹ Ibid, r 4.16G(1)(b).

⁴⁷⁰ Ibid, r 4.16G(2). See also St Clair and Drummond Young, *Corporate Insolvency*, paras 19-06 and 19-15.

⁴⁷¹ 1985 Act, s 463(1)(b).

⁴⁷² Including in administration where enforcement permission is obtained but no condition has been imposed requiring all surplus proceeds to be paid to the administrator.

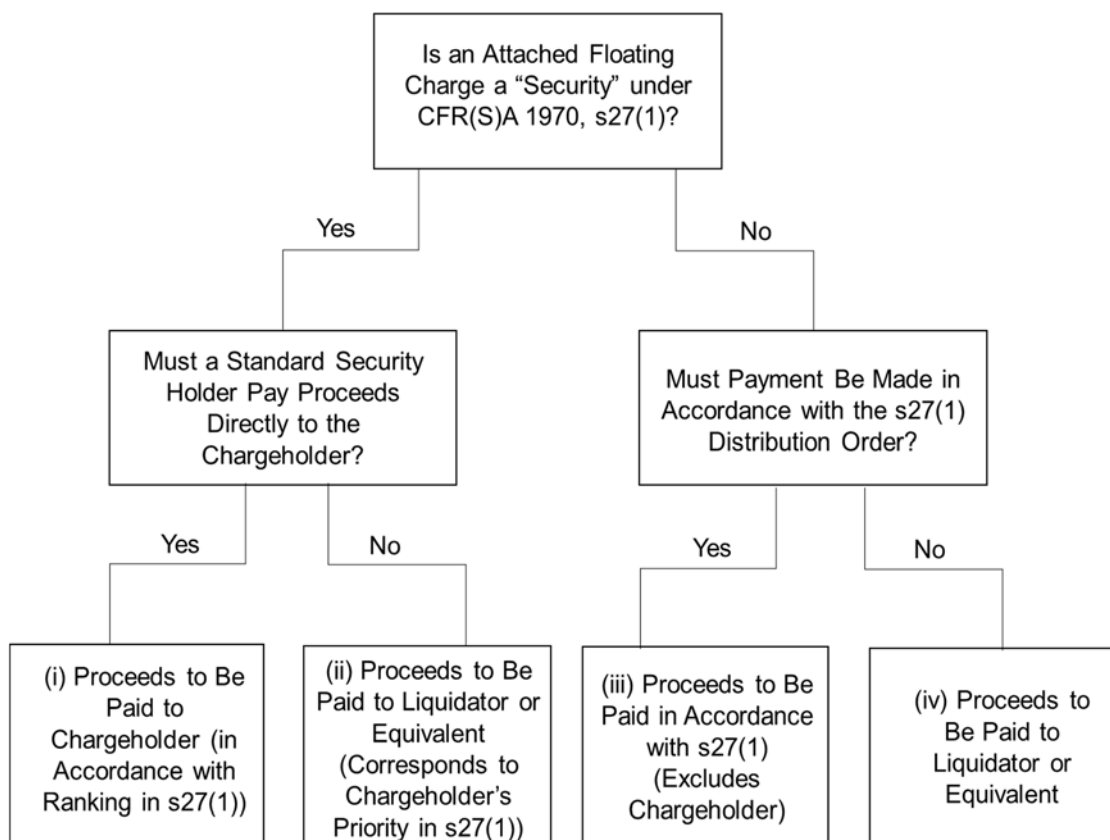

By virtue of the 1970 Act, s 27(1), a standard security creditor holds proceeds of sold property in trust for distribution according to a stated order of priority. The section provides, *inter alia*, that after payment of the whole sum due under the standard security, payment shall be made to those with "securities" postponed in ranking to that standard security, according to their respective rankings. Only after the satisfaction of debts due to those with such "securities" is any residue to be given to the party that was entitled to the property at the time of its sale or to another authorised person. The term "securities" clearly includes lower-ranking standard securities, but it has also been held to extend to inhibitions and would no doubt also apply to adjudications.⁴⁷³ Given that the floating charge attaches to heritable property "as if" it is a fixed security, there is a reasonable case that it is a "security" under s 27. This would ordinarily mean that surplus proceeds must be paid directly to the lower-ranking security holder. Thus, if approach (i) applies, B Bank would use the proceeds of sale to satisfy sums due to it, and then give any surplus proceeds to C Bank. This would circumvent the statutory enforcement

⁴⁷³ For inhibition see eg *Halifax Building Society v Smith* 1985 SLT (Sh Ct) 25; and the discussion at Gretton, *Inhibition*, 142ff. However, the 2007 Act, s 154(1), now provides that inhibitions give no preference in any ranking process. For adjudication and s 27 see Gretton, *Inhibition*, 221.

structures for the floating charge, which necessitate a representative of the company distributing to the chargeholder in an insolvency-type process. Direct payment to C Bank, and rights for C Bank directly against B Bank, could cause problems for preferential creditors and those with entitlement to the prescribed part; it is the liquidator (or receiver or administrator) who is obliged to make sums available to these parties.⁴⁷⁴ There is not an express duty, or specific mechanism, for the chargeholder to do this itself, if it receives payment from a secured creditor. The preferential creditors and prescribed part creditors could be left in the unfortunate position of trying to rely on unjustified enrichment in raising a claim against the chargeholder.⁴⁷⁵ Although this is a live risk with an unclear outcome, in some cases the issues could be avoided by the liquidator (or equivalent) using proceeds from another part of the estate to pay the preferential creditors and prescribed part creditors.

Approach (ii) can be supported by a broad reading of the phrase “in payment of any amounts due under any securities with ranking postponed to his own security”, in s 27(1)(d). Given that enforcement of a floating charge involves payment to its holder via a liquidator, receiver or administrator, B Bank might be correct to send proceeds, to the value of C Bank’s security, to one of these parties in order to pay C Bank. This wide interpretation of the provision does, however, become more strained when we consider that payment for the chargeholder will need to extend to sums due to parties which rank ahead of the floating charge but which are certainly not “securities”. This includes preferential creditor claims and the prescribed part. Even if these parties are included in the payment under s 27(1)(d), C Bank would have considerable practical problems identifying how much of the surplus proceeds ought to be paid over to the liquidator or equivalent. In the present example this would be of little consequence, as the next ranking party after the floating charge would be the company, and therefore, in reality, its insolvency representative. However, it could have implications if D Bank was a further standard security holder, but with a ranking lower than both B Bank and C Bank. This would mean that B Bank would require to make payment to satisfy C Bank (as well as those ranking ahead of C Bank such as preferential creditors), then to D Bank, before any further proceeds would be given to the company.

⁴⁷⁴ 1986 Act, s 176A; and s 175(2)(b); 1985 Act, s 463(3); and 1986 Rules, r 4.66(1)(b). However, a receiver may not distribute the prescribed part without the court’s permission, see 1986 Rules, r 3.8A; and see *Palmer’s Company Law* (n 191), para 13.213.2.

⁴⁷⁵ The potential success of which would be uncertain.

As will be seen from the diagram above, approaches (ii) and (iv) both involve B Bank making payment to the liquidator or equivalent. The difference is that in (ii) payment is made corresponding to the charge's ranking priority in s 27(1), while (iv) consists of payment contrary to the provisions of s 27(1). Under (iv) a floating charge is not a security for the purposes of s 27(1), perhaps because the charge's fixed security effect is limited to its enforcement context of liquidation, receivership or administration. Despite this, (iv) involves payment by B Bank to a liquidator or equivalent, which will facilitate distribution to C Bank. This can be justified by a certain interpretation of the interaction of s 27 and insolvency law. Higgins states that where property is sold by a standard security creditor and an insolvency practitioner has been appointed to the debtor, the first ranking creditor should deduct an amount sufficient to discharge the security and then pay the remaining proceeds to the insolvency practitioner, irrespective of whether there are other creditors.⁴⁷⁶ The judgment in *Alliance & Leicester Building Society v Hecht*⁴⁷⁷ supports this analysis. In that case, property was sold under a standard security and the security holder raised a multipointing regarding the disposal of the free proceeds. The debtor's trustee in sequestration and inhibiting creditors defended the action. It was held that the action was incompetent; the correct procedure was to pay the residue to the trustee, who could better ascertain and determine claims.⁴⁷⁸

Floating charges do not feature in *Hecht* or in Higgins' discussion, but the outlined approach makes considerable sense for their enforcement. A liquidator, receiver or administrator will be well-placed to distribute according to relative priorities. The proceeds which replace the attached heritable property that is sold by the liquidator or equivalent will be attached by the charge in turn. This is more efficient than having a multipointing running parallel to an insolvency process, which will already involve the identification of priorities for competing claims. The approach is desirable in practical and policy terms, but it departs from a formalist reading of s 27(1), and the apparent mandatory nature of the distribution order therein. Perhaps, however, the combination of: (a) s 27(1) necessitating the distribution of proceeds according to respective priorities; and (b) the insolvency process rendering the order of such priorities more uncertain; justifies the standard security holder giving monies to the liquidator or equivalent in order to fulfil his duties as trustee under s 27(1). The exact same outcome

⁴⁷⁶ M Higgins, *The Enforcement of Heritable Securities*, 2nd edn (2016), para 14.19.

⁴⁷⁷ 1991 SCLR 562.

⁴⁷⁸ At 566. In his commentary of the case, at 568, Gretton states that the decision "seems sound". There may also be the possibility of consigning the proceeds in court if the creditor is unable to obtain a discharge (1970 Act, s 27(2)) but it is unclear how this fits with the decision in *Hecht*.

could even apply where the floating charge *is* recognised as a security under s 27(1), if, rather than paying only the amount due to C Bank, all surplus proceeds are paid to the liquidator or equivalent when C Bank is the next ranking creditor. This would mean that the outcomes of approaches (ii) and (iv) converge.

Approach (iii) arises if: (a) surplus proceeds do not require to be paid by an enforcing fixed security holder to the administrator, receiver or liquidator; and (b) the floating charge is not deemed a security for the purposes of s 27(1). If this applies, then the floating charge ranking provisions in s 464 of the 1985 Act would be undermined. For example, a standard security in favour of D Bank, which ranks after B Bank’s standard security and C Bank’s floating charge, would receive proceeds under s 27(1) from B Bank, while C Bank would not.

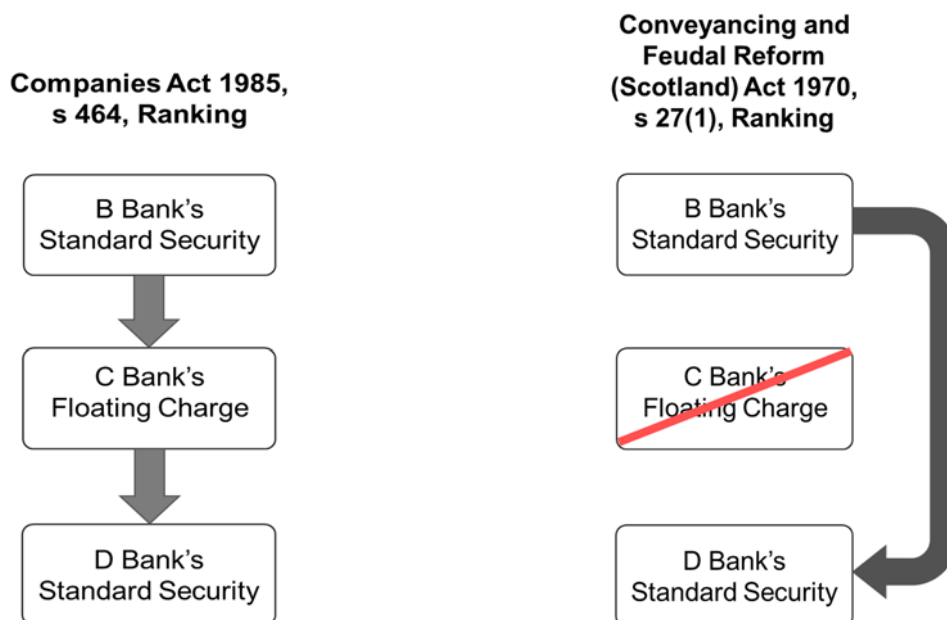

In terms of this approach, C Bank could only receive surplus proceeds once B Bank gives monies to the company, for distribution by the liquidator, administrator or receiver, which it will only do after paying any lower-ranking securities. An apparent conflict between the ranking outcomes of s 464 of the 1985 Act and s 27(1) of the 1970 Act is resolved in favour of s 27(1) for approach (iii). This could be considered a result of an attaching charge’s subjection to the rights of a higher-ranking standard security. But it would be a strained interpretation of the *rights* of that standard security holder. It would also mean that preferential creditors and the prescribed part claimants would lose out (unfairly) to D Bank.

There is, unfortunately, no definitive answer as to the present law on this enforcement issue. However, the preferred option from a policy and practical perspective is for the standard security holder to give surplus proceeds to the receiver, liquidator or administrator to deal with all other priorities and distribute accordingly. Consequently, approach (iv) is recommended, as is approach (ii), but only where it involves the transfer of all surplus proceeds to receiver or equivalent, not just the chargeholder's allocation.

The above material has focused on the standard security, as the conflict between the statutory distribution provisions and how any entitlement of a chargeholder can be given effect to is the context within which the problem is most apparent. An interpretation which does not adhere to a strict, narrow view of s 27 also allows greater scope for consistency with enforcement for other types of property. For instance, a pledgee, as a secured creditor,⁴⁷⁹ can seek to enforce separately from the liquidation or receivership but the common law background dealing with proceeds of sale allows for more flexibility in holding that the surplus proceeds should be directed to the pledgor's receiver, liquidator or administrator.⁴⁸⁰ Nevertheless, the introduction of a new form of security over moveables proposed by the SLC could provide some further statutory complications, dependent upon the provisions of eventual legislation, and may make the problems above more commonplace for moveable property.⁴⁸¹

(2) Lower-Ranking Fixed Security Holder

There are also issues if we amend the example above so that C Bank's floating charge, which attaches to heritable property belonging to A Ltd, actually ranks *ahead of* B Bank's standard security.⁴⁸²

⁴⁷⁹ In 1986 Act, s 248, "secured creditor" is defined widely as "a creditor of the company who holds in respect of his debt a security over property of the company" and "security" means "in relation to Scotland, any security (whether heritable or movable), any floating charge and any right of lien or preference and any right of retention (other than a right of compensation or set-off)".

⁴⁸⁰ Ordinarily, surplus proceeds are paid to the pledgor, see Steven, *Pledge*, para 8-06. And see para 15-08 where it is suggested that a lienholder would pay surplus proceeds to the liquidator (or equivalent) rather than the debtor.

⁴⁸¹ See the proposals in SLC, *Moveable Transactions*. There are currently few circumstances in which moveable property can be encumbered by more than one fixed security.

⁴⁸² Additional difficulties would arise where there are all sums securities and notice is given in terms of 1970 Act, s 13, or 1985 Act, s 464(5). These include the extent to which notice by a chargeholder can affect the priority of a standard security holder and vice versa. See eg *Halliday's Conveyancing*, vol 2, paras 51-19f, 56-26 and 57-31, for general discussion of such notice.

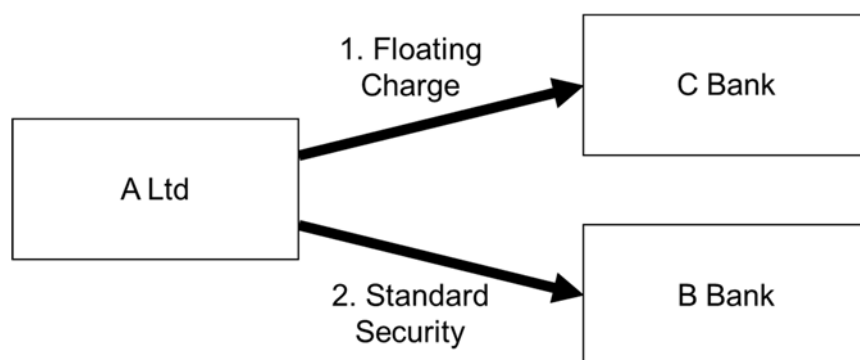

For administration, similar considerations as above will apply. However, if an administrator or court allows a lower-ranking fixed security holder to enforce this could be highly prejudicial to the chargeholder if attachment has not occurred.⁴⁸³ With respect to receivership, the powers of a receiver are not subject to the rights of a lower-ranking fixed security holder.⁴⁸⁴ This may preclude the possibility of enforcement by such a fixed security holder; however, it is more likely that either party can enforce but that the receiver's powers override those of the fixed security holder.⁴⁸⁵ Thus, a fixed security holder's power to sell the property is subject to the receiver's power of sale. In this area then, the receiver's powers have a connection with the ranking position of the chargeholder. Given the relative ranking of enforcement powers, a fixed security holder wishing to enforce should obtain the consent of a receiver. Conversely,

⁴⁸³ The guidelines derived from *Atlantic Computer Systems* (n 458), would suggest that permission ought not to be granted in such a situation. Alternatively, it could be granted subject to appropriate conditions regarding priority payments to the administrator.

⁴⁸⁴ Cf the position for higher-ranking fixed security holders noted above.

⁴⁸⁵ In some cases, it could be advantageous to the chargeholder for the fixed security holder to enforce instead of the receiver seeking to immediately realise: eg where on day 1 a floating charge is created with a negative pledge; on day 2 a fixed security is created; on day 3 another type of subordinate real right is established; and on day 4 the floating charge attaches. There is a priority problem of sorts: the charge ranks ahead of the fixed security, which the other real right seems to be subject to, but the floating charge itself is subject to the other real right. This is a result of there being separate priority rules involving: (i) the charge and fixed security rights; and (ii) the charge and other real rights. While a receiver may be unable to reduce the other real right, it seems that the fixed security holder could do so – see eg *Trade Development Bank v Warriner & Mason (Scotland) Ltd* 1980 SC 74; *Trade Development Bank v David W Haig (Bellshill) Ltd* 1983 SLT 510; and Higgins, *Enforcement of Heritable Securities* (n 476), para 13.9; but cf KGC Reid, “Real Conditions in Standard Securities” 1983 SLT (News) 169 and 189. Similar situations might arise in liquidation or administration but it will be more difficult for the chargeholder to exert control over how enforcement against the property takes place.

a receiver requires the consent of even a lower-ranking secured creditor (or the court) to sell secured property free from the encumbrance.⁴⁸⁶

The attachment of a floating charge in liquidation is not subject to lower-ranking fixed securities (or floating charges).⁴⁸⁷ But the liquidator ranks behind the fixed security holder and, without a very wide reading of the effect of an attaching charge on a liquidator's powers, cannot act on behalf of the chargeholder to stop the creditor from selling.

Usually when enforcing, B Bank would be required to pay proceeds to the holder of "any prior security to which the sale is not made subject" (1970 Act, s 27(1)(b)), before itself taking payment for sums secured by its standard security (s 27(1)(c)). This poses some questions if B Bank is able to enforce, despite its lower ranking relative to C Bank's attached charge: it is again necessary to consider if C Bank's charge is a "security" under s 27(1) and whether payment can be made directly to C Bank, or if it is instead to be given to A Ltd's liquidator or equivalent. It would be inconceivable if both of the following applied: (i) that the charge is not a security; and (ii) that payment to the liquidator or equivalent is not required. And, as before, there are practical and policy arguments against payment to the chargeholder directly.

Where payment is being made in accordance with s 27(1), perhaps B Bank, as the lower-ranking fixed security holder, must pay proceeds to the liquidator, receiver or administrator. These latter parties would be the vehicle for payment of amounts due to C Bank, the higher-ranking security holder, with any remainder to be retained by B Bank itself up to the amount of debt owed to it. This is, however, counter-intuitive as determining such an amount will be extraordinarily challenging for a creditor, especially when preferential creditors, the prescribed part, the chargeholder's claim and expenses of the liquidator or receiver are to be taken into account.⁴⁸⁸ Claims could be made against the fixed security holder by a liquidator, receiver or administrator if an incorrect amount was paid over.

⁴⁸⁶ 1986 Act, s 61(1)(a): as well as the consent of higher-ranking or *pari passu* ranking secured creditors (s 61(1)(a)) and those with effectually executed diligence (s 61(1)(b)).

⁴⁸⁷ By implication from 1985 Act, ss 463(1)-(2) and 464.

⁴⁸⁸ These claims do not require to be paid from proceeds arising from the enforcement of the heritable property but are rather claims against the estate as a whole. However, discovering the extent to which the rest of the estate can bear the claims will prove troublesome.

If B Bank did sell the property, the uncertainty regarding the allocation of the proceeds might justify a multiplepointing. However, the competence of this may be doubted.⁴⁸⁹ Alternatively, B Bank could give all the proceeds to the liquidator or equivalent for distribution, but then what would be the point of a sale of the property by B Bank?⁴⁹⁰ In fact, in many cases B Bank will receive little or nothing after the deduction of prior claims and there will thus be minimal value in enforcing. It will therefore be sensible for the fixed security holder to let the liquidator or equivalent realise the property and distribute according to priorities.

A further possibility, that a sale of the property by B Bank could mean a transferee's title remains subject to C Bank's floating charge, by virtue of s 26(2), must be rejected. Even if a floating charge can be a "security",⁴⁹¹ it would apparently be unenforceable against the transferred property as the enforcement of the charge is limited to the patrimony of the chargor;⁴⁹² there is no enforcement mechanism that allows for enforcement against a valid purchaser.⁴⁹³ The liquidator of the transferor will not be able to proceed against the transferee, and a secured creditor or insolvency administrator of the *transferee* could not be expected to give effect to the charge.

D. LIQUIDATION

When considering the floating charge's nature and operation, it is important to recall that liquidation was the only method of enforcement upon the charge's introduction to Scots law. The charge was therefore constructed in this context, and its effect in liquidation offers a template for the security more widely. However, despite the floating charge being a single concept in Scots law, the consequences of attachment may vary dependent upon whether the charge attaches in a liquidation, receivership or administration.⁴⁹⁴ In the present context, liquidation is the most fertile ground for the view that attachment and enforcement are

⁴⁸⁹ See Higgins, *Enforcement of Heritable Securities* (n 476), para 14.19. Cf *Hecht*, where a multiplepointing was held not to be competent in the circumstances.

⁴⁹⁰ However, see n 485 for when it might be of benefit.

⁴⁹¹ Or "heritable security", see s 26(1) and (2). In the context of land registration, a floating charge is not a "heritable security" – 2012 Act, s 113(1).

⁴⁹² See further below.

⁴⁹³ There is also no registration in the Land Register (or equivalent), as there is for other security rights, only registration against the person of the chargor in the charges register.

⁴⁹⁴ See eg *Commissioners of Customs and Excise v John D Reid Joinery Ltd* 2001 SLT 588.

separable. And the enforcement of a charge attaching in liquidation appears limited to the property which a liquidator, from time to time, has power to realise.

(1) Property Limitations

As regards the property of a company in liquidation, a liquidator principally acts as that company's agent (and administrator).⁴⁹⁵ His role is "to secure that the assets of the company are got in, realised and distributed to the company's creditors...".⁴⁹⁶ To do this, the liquidator is required to "take into his custody or under his control all the property and things in action⁴⁹⁷ to which the company is or appears to be entitled".⁴⁹⁸ It is assumed that entitlement here corresponds to the company's ownership of property (in accordance with Scots property law). The liquidator has a range of powers relating to the company's property, include powers to sell and transfer it and to do all acts and execute deeds on the company's behalf.⁴⁹⁹ The liquidator's reach is, however, limited to the company's private patrimony and the property therein.⁵⁰⁰ And this has implications for a chargeholder seeking enforcement through the liquidator.

A related issue is that, unlike for a trustee in sequestration, property does not automatically vest in a liquidator upon appointment. Instead, an application to the court for the vesting of "property... belonging to the company" would be necessary.⁵⁰¹ To acquire title to heritable

⁴⁹⁵ See 1986 Act, ss 165(2), 167(1), Sch 4; *Joint Liquidators of Scottish Coal Co Ltd v Scottish Environment Protection Agency* [2013] CSIH 108; 2014 SC 372; *Smith v Lord Advocate* 1978 SC 259 per LP Emslie at 273; and see the discussion of the liquidator's status at St Clair and Drummond Young, *Corporate Insolvency*, paras 4-36ff. However, a liquidator, like a receiver or administrator, is not a typical agent. Usually, an agent is appointed by a principal and his agency status is revocable and, even though an agent has authority to act on the principal's behalf, the principal still retains the power to carry out the same acts. This is not true for liquidation, receivership and administration. The wider term "representation" may be more appropriate in these contexts.

⁴⁹⁶ 1986 Act, s 143(1). This is for winding up by the court.

⁴⁹⁷ This term is inappropriate in Scots law and is already included in "property".

⁴⁹⁸ 1986 Act, s 144(1). See also 1986 Rules, r 4.22(1)(a), which provides that the liquidator shall "as soon as may be after his appointment take possession of the whole assets of the company and any property, books, papers or records in the possession or control of the company or to which the company appears to be entitled".

⁴⁹⁹ 1986 Act, Sch 4, paras 6 and 7. And see St Clair and Drummond Young, *Corporate Insolvency*, paras 4-47ff, for further details of the liquidator's powers.

⁵⁰⁰ Property in the company's trust patrimony is seemingly excluded from liquidation (see n 610).

⁵⁰¹ 1986 Act, s 145(1). In *Scottish Coal* (n 495), at para 121, the court noted that s 145 orders are "rare". St Clair and Drummond Young, *Corporate Insolvency*, para 4-05, n 28, state: "The authors know of no case in which these provisions have been used in Scotland". As St Clair and Drummond

property, the liquidator would then need to register in the Land Register. A quicker method would be to record or register a notice of title, which completes title in favour of the liquidator (and without having to apply to the court for vesting under s 145).⁵⁰²

Upon winding up, some previous transactions (unfair preferences, gratuitous alienations and extortionate credit transactions)⁵⁰³ can be challenged by the liquidator or particular creditors and, if successful, can cause property to revert to the insolvent company.⁵⁰⁴ Conversely, where ownership of property remains with the insolvent company, it is possible for other parties to acquire it, but only in certain limited circumstances. In voluntary liquidations, the appointment of a liquidator causes the powers of directors to cease, which serves to stop disposals except by the liquidator.⁵⁰⁵ It seems that a winding up by the court also removes the powers of the directors.⁵⁰⁶ In the latter case, any “disposition” of the company’s property after the commencement of winding up is void unless otherwise ordered by the court.⁵⁰⁷ “Disposition” is used here in a wide sense, and has been interpreted to mean the company “dealing with or settling or transferring its property to another”.⁵⁰⁸ In other words, positive acts (whether voluntary or obligatory)⁵⁰⁹ by the company relating to transfer of property are void, unless ordered by the court or carried out by the liquidator. This places a significant obstacle in the way of a floating charge creditor being defeated by a transfer of attached property which moves the property beyond the ambit of the liquidation.

Young note, there is also the possibility of an application for vesting under s 112(2) for a voluntary winding up.

⁵⁰² Titles to Land Consolidation (Scotland) Act 1868, s 25, as amended, and Conveyancing (Scotland) Act 1924, ss 3 and 4; Reid, *Property*, para 648, n 10. (Reid notes that liquidators “rarely complete title in their own name”.) For discussion, see GL Gretton “The Title of a Liquidator” (1984) 29 JLSS 357; AJ McDonald, “Bankruptcy, Liquidation and Receivership and the Race to the Register” (1985) 30 JLSS 20; GL Gretton and KGC Reid “Insolvency and Title: A Reply” (1985) 30 JLSS 109; SLC, *Sharp Report*, paras 4.1ff.

⁵⁰³ 1986 Act, ss 242-244.

⁵⁰⁴ See 62ff regarding the implications of this for attachment.

⁵⁰⁵ 1986 Act, ss 91(2) and 103.

⁵⁰⁶ There are not equivalent provisions for compulsory liquidations but the directors’ powers must generally cease (even if they formally remain in office and retain certain residuary powers), as the liquidator acquires a wide range of powers and it would be odd and highly impractical if the directors could also exercise them: McKenzie Skene, *Insolvency*, 176; McBryde, *Contract*, para 3-108. And see St Clair and Drummond Young, *Corporate Insolvency*, para 4-06.

⁵⁰⁷ 1986 Act, s 127(1). For a recent Supreme Court case considering s 127, see *Akers v Samba Financial Group* [2017] UKSC 6; [2017] AC 424.

⁵⁰⁸ *Site Preparations Ltd v Buchan Development Co Ltd* 1983 SLT 317 per Lord Ordinary (Ross) at 319. Lord Ross held that such a disposition included the creation of a floating charge after commencement of winding up, due to its immediate attachment to property.

⁵⁰⁹ Inhibition (another person and property-focused security interest), only affects future voluntary acts, and only makes such acts voidable *ad hunc effectum* – see Gretton, *Inhibition*, 97f and 129f.

As McKenzie Skene states, the time at which a disposition is deemed to occur is critical.⁵¹⁰ English law seems to utilise the transfer of beneficial entitlement, upon conclusion of sale contract, as the key stage – after which there is no “disposition”.⁵¹¹ Beneficial entitlement is unlikely to be the equivalent test in Scotland, not least because of the rejection of the beneficial interest doctrine in wider law in *Burnett’s Tr.*⁵¹² Nevertheless, in Scots law, it is almost certain that the s 127 concept of a “disposition” stops applying to acts involved in transfer at a stage prior to the actual transfer of ownership. “Disposition” implies that the insolvent company is taking an active step (whether or not in fulfilment of an existing obligation) to, for example, transfer property (or create a real right in that property).⁵¹³ If the company had carried out all of *its* obligations relating to the transfer before the commencement of the winding up, then steps taken by the *transferee* to complete title would not constitute a disposition. This is supported by the fact that if a disposition of heritable property has been delivered to the transferee,⁵¹⁴ before liquidation of the transferor, the transferee can defeat the liquidator by registering first in the Land Register.⁵¹⁵ If, instead, registration by the transferee (and thus the transfer of ownership) was a “disposition”, then the transfer would be void, the liquidator would succeed and the “race to the register” would not apply. That does not appear to be the current law.⁵¹⁶

(2) Removal of Property from Patrimony

If a buyer is in a position to obtain property and then completes the final step in the transfer, the property is removed from the insolvent company’s patrimony, and thus from the liquidator’s grasp. In this context, the obligations required to have been fulfilled by the transferor by the beginning of liquidation, and the final step necessary by the transferee, differ

⁵¹⁰ McKenzie Skene, *Insolvency*, 175. See also *Palmer’s Company Law* (n 191), para 15.702.

⁵¹¹ *Re French’s Wine Bar Ltd* (1987) 3 BCC 173; Goode, *Principles of Corporate Insolvency*, paras 13-127ff. And see McKenzie Skene, *Insolvency*, 175.

⁵¹² See 171ff.

⁵¹³ This would mean that delivery of a disposition in fulfilment of an existing obligation is also a “disposition”.

⁵¹⁴ Which is ordinarily the last active step by the transferor.

⁵¹⁵ Reid, *Property*, para 648.

⁵¹⁶ On the race to the register, see: *Burnett’s Tr*; Reid, *Property*, para 648; *Greene and Fletcher: Receivership*, 2.04f; cf D McKenzie Skene, “The Shock of the Old: *Burnett’s Tr v Grainger*” 2004 SLT (News) 65 at 70f.

dependent upon the type of property involved. For heritable property, the disposition must have already been delivered and the (purported) transferee requires to register; for corporeal moveable property, parties may agree when ownership is to pass for the sale of goods (under the 1979 Act, s 17) and what steps are required to bring this about;⁵¹⁷ and for incorporeal property, an assignation must have been delivered and the assignee must intimate (or complete an equivalent step).⁵¹⁸ (It would even be possible for a liquidator, administrator or receiver who had been (coincidentally) appointed over the *transferee's* property to complete this step on behalf of the transferee.)⁵¹⁹ At any earlier stage than those previously mentioned for each property type, the liquidator (or equivalent) of the transferor, could simply refuse to act or abandon the relevant contract.⁵²⁰

Of course, floating charges attach upon the commencement of the chargor's liquidation. A floating charge attaches to the property then comprised in the company's property and undertaking. And the enforcement of the floating charge, including realisation of the attached property and distribution, occurs through the medium of the liquidator.⁵²¹ Therefore, what happens if, between attachment and the property vesting in, or being realised by, the liquidator, the property transfers to another party, by virtue of that party carrying out the final necessary step? On the basis of what has been discussed above, the liquidator would be defeated by the transferee and could no longer realise the property to distribute to the chargeholder.⁵²² Consequently, it seems that although the floating charge attaches to the property, it becomes unenforceable in the liquidation. Its enforceability is dependent upon the property remaining in the chargor's patrimony, even after attachment.

⁵¹⁷ See 208ff.

⁵¹⁸ Reid, *Property*, para 659 n 3, tentatively suggests that a liquidator differs from a trustee in sequestration, who prevails against an unintimated but delivered assignation due to sequestration acting like a conveyance of incorporeal property. Reid proposes that in a liquidation the winner between intimation and s 145 vesting is likely to prevail. See also Wilson, *Debt*, para 25.7, who is of the same view regarding the existence of an equivalent to the race to the register for this type of property.

⁵¹⁹ A floating charge granted by the transferee would have attached to the personal rights to obtain the property, which would be subsequently replaced by attachment to the transferred property (see 62ff).

⁵²⁰ For details of adoption and abandonment of contracts, see *Crown Estate Commissioners v Liquidators of Highland Engineering Ltd* 1975 SLT 58; St Clair and Drummond Young, *Corporate Insolvency*, para 4-07; Wilson, *Debt*, para 25.7.

⁵²¹ *Halliday's Conveyancing*, vol 1, para 2-128, recommends that the liquidator should obtain the consent of the chargeholder when selling attached property. This is presumably on the basis that the charge attaches "as if" it is a fixed security for the purposes of liquidation.

⁵²² Or to other parties ranking ahead of, or behind, the chargeholder.

Where property is validly transferred after liquidation, a floating charge could only remain enforceable if its attachment confers a power upon the liquidator to recover the property. There is no obvious basis in the legislation to support this. The fact that a floating charge attaches as if it were a fixed security (under s 463(2)) for the purposes of winding up provisions in the 1986 Act does not assist. The existence of a fixed security does not allow a liquidator to recover property transferred out of the insolvent company's patrimony. If such a transfer occurred, a fixed security could still be independently enforced against the transferee, unlike the floating charge, which requires a representative of the chargor to do so. An attempt by the liquidator to interdict the registration by the transferee would also be ineffective. The purpose of an interdict is to stop a wrong from being committed; registration to obtain a real right in fulfilment of rights under contract cannot be so classified. In fact, if the transferee could not complete title, that would itself ordinarily be a wrong due to breach of warrandice.⁵²³

If the floating charge cannot be enforced despite attachment, this does not mean that the effect of attachment is redundant. In the vast majority of cases attachment will enable enforcement to take place. It is only in exceptional circumstances, where property can still be transferred from the insolvent company to another after the commencement of liquidation, that attachment will not lead directly to (potential) enforcement. Another similar example is where the floating charge attaches but, because it is not registered in the charges register, is void against various parties.⁵²⁴

E. RECEIVERSHIP

(1) The Receiver and Property

Receivership is the enforcement process that is closest to self-enforcement for a chargeholder.⁵²⁵ But it is, nevertheless, the receiver, rather than the chargeholder, who has the

⁵²³ These points regarding interdict would also apply to an interdict attempt by a receiver or an administrator.

⁵²⁴ 2006 Act, s 859H(3).

⁵²⁵ In Scotland, receivership was introduced as a means for enforcing floating charges without requiring liquidation, and cannot be used by other creditors. (However, allowing other creditors to apply to the court for the appointment of a receiver was considered by the SLC – see “Notes on

powers to realise the property subject to the security, and he does this without a real right in the property.⁵²⁶ A receiver, like a liquidator, acts as an agent of the company as regards the company's property; however, unlike a liquidator, a receiver is only an agent with respect to *attached* property.⁵²⁷ A chargeholder can appoint a receiver "of such part of the property of the company as is subject to the charge."⁵²⁸ And, upon appointment, the floating charge attaches to "the property then subject to the charge".⁵²⁹ The 1986 Act, s 55(1), specifies that a receiver "has in relation to such part of the property of the company as is attached by the floating charge... the powers, if any, given to him by the instrument creating that charge." The relevant potential powers that can be given under a charge are thus wide in scope but, logically, can only extend to those that could be held by a chargor. And these powers are limited to property which is: (i) the company's; and (ii) attached by the charge.⁵³⁰ A chargor could not, for example, confer powers upon the receiver for property no longer belonging to the chargor.

The 1986 Act, s 55(2), does, however, give the receiver the additional powers in Schedule 2 of the Act, as regards the property mentioned in s 55(1). Schedule 2, para 1, provides that a receiver has: "Power to take possession of, collect and get in the property from the company or a liquidator thereof or any other person, and for that purpose, to take such proceedings as may seem to him expedient." And the following paragraph (para 2) empowers the receiver "to sell, hire out or otherwise dispose of the property..." It is therefore important to establish the meaning of "the property" in this context. Does it mean any property attached by the floating charge, even if it is no longer the company's property, or is it limited to the company's property at any given time, and thus excludes validly transferred property? Section 55(1) can be read in both ways. It is possible to consider "such part of the property of the company" and "attached by the floating charge" to be one concept connecting attachment to the company's property when attachment occurs and allowing the exercise of powers thereafter irrespective

Amendments to Memorandum No 10" dated 2 May 1969, and letter by JM Halliday to R Brodie dated 5 May 1969, in *Scottish Law Commission Papers: L45/174/1*. Cf English law where receivers can be appointed in a wide variety of cases – see S Frisby and M Davis-White (eds), *Kerr and Hunter on Receivers and Administrators*, 19th edn (2010), chs 1-3.

⁵²⁶ See GL Gretton and KGC Reid, *Conveyancing*, 4th edn (2011), para 29.08; Paisley, *Land Law*, paras 11.27ff. But, as Paisley notes, the chargeholder has the right to require the cooperation of the receiver, including to dismantle the company for the chargeholder's benefit.

⁵²⁷ 1986 Act, s 57(1). St Clair and Drummond Young, *Corporate Insolvency*, para 6-46.

⁵²⁸ 1986 Act, s 51(1). The equivalent for appointment by the court is s 51(2).

⁵²⁹ *Ibid*, s 53(7). The equivalent for appointment by the court is s 54(6).

⁵³⁰ There may be other limitations, such as a receiver not succeeding to powers which the chargor holds as a representative in relation to the property of another.

of the ownership position. Alternatively, these parts of the term are separate, which means that property needs to be the company's *and* be attached by the charge, in order for the receiver to have powers exercisable over such property at a given moment.

The alternative view appears to be supported by the receiver's agency in relation to *the company's* property. It stands to reason that the powers of a receiver over property correspond to the limits of his agency status. If the company's property can be validly transferred to another party, after the appointment of the receiver, then clearly the receiver's status will not enable him to deal with that property. The fact that the company, even if it was not in receivership, would not have any powers over the transferred property, also supports this view.

On what basis then could a receiver exercise powers over property belonging to a party other than the company? A receiver does act in the interests of the appointing chargeholder and a floating charge attaches "as if" it is a fixed security. Furthermore, receivership is "a procedure for the realisation of a security".⁵³¹ If the chargeholder had a fixed security and the receiver was its agent, it could enforce against a third party. A receiver might also have such an ability if, as one commentator has suggested, he is "regarded as if he held a completed security (for behoof of the charge-holder) at the date of crystallisation", despite title remaining with the company.⁵³² However, the statutory provisions do not seem to support these positions. The receiver is not formally the agent or representative of the chargeholder and does not hold any security over the property in question. Given the statutory introduction of receivership into Scots law, one would expect such effects to be outlined in legislation. In addition, an attached charge does not confer the enforcement methods available to fixed security holders; and its operation as a fixed security may even be limited to the context of receivership as a statutory regime, and to areas of law interacting with the receivership. Receivership is a specific vehicle for enforcement of the floating charge but its operation relies on the receiver acting for the company.⁵³³ Therefore, the ability to enforce appears limited to the company's property as it changes during the receivership.

⁵³¹ DA Bennett, "The Receiver in Scotland" in S Frisby and M Davis-White (eds), *Kerr and Hunter on Receivers and Administrators*, 19th edn (2010), para 27.4.

⁵³² *Palmer's Company Law* (n 191), para 14.213.

⁵³³ And see *Myles J Callaghan* (n 355) per Lord Ordinary (Prosser) at 179f and 182, who notes that, for the recovery of a *jus crediti*, it is "for the company to vindicate its rights", even if it is in receivership, and the receiver would therefore be required to raise an action in the name of the company and on its behalf.

Where a company is in receivership, property which is not attached can be freely dealt with by the directors. But there is no “diarchy” with respect to attached property; the receiver supersedes the directors, who generally have no power over this property during the receivership.⁵³⁴ As McKenzie Skene notes, the obvious implication of directors dealing with property without the necessary power is that such a transaction is void and the property may be recovered by a receiver.⁵³⁵ If, for example, the directors delivered a disposition after the appointment of a receiver, the disposition and subsequent registration of ownership would be void; the directors would not have had the requisite power to deliver a valid disposition to enable ownership to transfer.⁵³⁶ The property would therefore continue to belong to the debtor company and the floating charge would remain enforceable.

If a transfer is completed during the receivership, the transferee may have registered (as in *Sharp*), intimated or otherwise publicised the transfer according to the relevant legal requirements. (And they may have done so prior to the publication of any details regarding the appointment of a receiver and the charge’s attachment.) On what basis can a receiver interfere and prevail when confronted with such publicity and where the law regards the transfer as valid? On what grounds could a receiver reduce the transfer? It might be said that if X Ltd grants a floating charge to Y Ltd then, for example, corporeal moveable property will be attached as if the charge is a pledge. This would mean that if any such property is validly transferred from X Ltd to Z Ltd, after the attachment of the charge, then Z Ltd takes the property subject to the security. This would enable Y Ltd to realise the property even though it is owned by Z Ltd. But there are objections to this. Y Ltd, as a chargeholder, cannot itself enforce, unlike a pledgee.⁵³⁷ And the receiver’s enforcement abilities rely on him operating as an agent for X Ltd as regards that party’s property. A pledge, and other (true) fixed securities,

⁵³⁴ *Imperial Hotel* (n 464); *Independent Pension Trustee* (n 337). In the latter case, Lord Hamilton doubted *Shanks v Central Regional Council* 1987 SLT 410, insofar as Lord Weir in *Shanks* suggested that directors retain residual rights in some circumstances (Lord Weir did, however, support the general view that directors cannot exercise powers where receivers have the powers). McKenzie Skene, *Insolvency*, 174, n 20, doubts this too, and see DW McKenzie and D O’Donnell, “Intervening Insolvency: How Can You Know?” (1996) SLPQ 173 at 179f.

⁵³⁵ McKenzie Skene, *Insolvency*, 176; and see *Greene and Fletcher: Receivership*, paras 2.21ff.

⁵³⁶ 2012 Act, s 50(2), requires registration of a valid disposition for ownership to be transferred. It would not be valid if there was no power to transfer. There could, however, have been complications under the “Midas touch” inherent within the Land Registration (Scotland) Act 1979 regime.

⁵³⁷ And this also overlooks the fact that a pledgee requires a court order unless the pledgor grants an express power of sale – see Steven, *Pledge*, paras 8-04ff.

can cross patrimonial boundaries when the encumbered property transfers but a floating charge seemingly cannot.

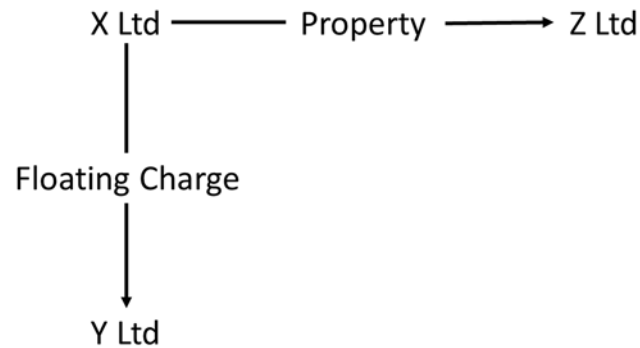

There are additional complications if Z Ltd quickly sells property to A Ltd.



If Y Ltd could enforce when Z Ltd is owner, due to the pledge analogy, then this should transmit to facilitate enforcement in relation to A Ltd, and subsequent successor owners, as pledge would.⁵³⁸ But a pledgee's right is compliant with the publicity principle by being identifiable from that party's possession of the property. (The same would be true with respect to a standard security, which is registered against the property, and this information is readily available to prospective transferees.) By contrast, the floating charge is non-possessory and registered not against the property but against the person of *X Ltd* in the charges register.

⁵³⁸ Steven, *Pledge*, para 8-01.

Although one can expect Z Ltd to check the charges register for X Ltd, the party Z Ltd is transacting with, it is probably too burdensome for A Ltd (and A Ltd's successors) to do so with respect to X Ltd; each step in the chain makes X Ltd's patrimony and Y Ltd's charge more remote.⁵³⁹

The *sui generis* attachment hypothesis is even less supportive of the charge being enforceable against parties other than the chargor. The charge would attach as if it is a general security over property effective in the chargor company's winding up. This can be considered to imply that the property must be within the chargor's estate for the charge to be enforced against it, or it must be expressly recoverable by the liquidator or equivalent. There is scant statutory authority that would support enforcement of the charge beyond the chargor's patrimony.

(2) Uniformity with Liquidation?

Another point in favour of separating attachment and enforceability for receivership is to bring a significant degree of uniformity across the different methods of enforcement of floating charges. The position for liquidation seems relatively clear and there ought to be a presumption that the same is applicable to receivership. Although receivership is principally a security enforcement regime, aspects of the law of receivership in Scots law are comparable to, and based upon, liquidation.⁵⁴⁰ And, as noted by Goode in relation to English law, administrative receivership has a number of traits of an insolvency regime, like liquidation and administration, and is treated as such in various respects.⁵⁴¹ The same applies in Scots law.⁵⁴² It is certainly true that the "agency" (representative) status of a receiver, as regards the

⁵³⁹ This will be even more apparent if Z and A are not companies and there is no charges register for them. Also, see now the 2012 Act, s 93, which provides that a good faith acquirer of land is not affected by a floating charge granted by the disponent's predecessor in title.

⁵⁴⁰ *Palmer's Company Insolvency*, para 201, notes that the receiver's powers and duties and other receivership rules are "closely based upon" the rules for winding up and should be considered as part of corporate insolvency.

⁵⁴¹ See RM Goode, *Principles of Corporate Insolvency Law*, 3rd edn (2005), para 1-23; and see also Goode, *Principles of Corporate Insolvency*, para 10-06.

⁵⁴² Eg the receiver's duties to make sums available for preferential creditors and the prescribed part. Also, insolvency proceedings outlined in the 2007 Act, ss 155(4) and 208(12), include receivership. And in 1970 Act, Sch 3, para 9(2)(c), a proprietor is deemed to be insolvent if *inter alia* a receiver is appointed. However, a receiver can be appointed where the company is still solvent. This is also true of administration and liquidation.

company's property, and the powers available to him, bear close similarity to those of a liquidator.

Liquidation was the original means by which the floating charge could be enforced in Scots law and seems to require that the property continues to belong to the insolvent party.⁵⁴³ If there is a “default” law of floating charges it is the floating charge attaching in liquidation. Why, then, should the introduction of receivership in 1972 have fundamentally altered the law of floating charges, beyond being a special enforcement method outside formal liquidation? And why should the alternative method of enforcement allow wider scope for recovery than liquidation, without express statutory provision? The idea that a receiver ought not to have greater powers over property than a liquidator was a key consideration in *Sharp*.⁵⁴⁴ Lord Clyde preferred a narrow construction of the floating charge, noting the privilege a receiver would otherwise achieve, in comparison to a liquidator or trustee in sequestration, by being able to sell the property without recording title and without engaging in a race to the register against the transferee.⁵⁴⁵ Separating attachment from enforcement was not, however, argued in the case. Lord Jauncey noted that the receivers had the power to take possession of the company's property and sell it,⁵⁴⁶ but in deciding the property was not the company's under the legislation, he analysed the meaning of property upon attachment rather than when enforcement was taking place.⁵⁴⁷

It would have been possible to reach the same outcome as in *Sharp* by using the “separation” approach. This could have avoided the property law difficulties arising from the case, including determining the meaning of beneficial interest. The property would be available to a receiver for realisation until the property was removed from the company's patrimony. This would only be possible if the company did not require to take any further active steps after the receiver's appointment. For heritable property, this could only occur if the disposition had been delivered before the receiver was appointed, thus enabling subsequent recording or registration, as in *Sharp*. Even if *Sharp* remains the approach for heritable property and receivership, a separation of attachment and enforcement could apply for non-heritable

⁵⁴³ See above.

⁵⁴⁴ Eg per Lord Jauncey at 77.

⁵⁴⁵ Per Lord Clyde at 83.

⁵⁴⁶ Referring to the 1986 Act, s 55 and Sch 2.

⁵⁴⁷ Per Lord Jauncey at 76.

property and for non-receivership cases. For corporeal moveables, an earlier delivery of the property would be necessary for transfer at common law, while under the 1979 Act, the parties can agree when ownership will transfer.⁵⁴⁸ For incorporeal property, an earlier delivery of an assignation deed would allow for the assignee to complete the assignation by intimation (or equivalent) during the receivership. As noted above, the fundamental point is that the purported transferee can complete title without the assistance of the transferor. Thus, although the *outcome* in *Sharp* is supported by the analysis above, it could more appropriately have been decided on the basis of separating enforcement from attachment. Even though the charge had attached to the property, by the time that enforcement was to take place the property no longer belonged to the chargor and was therefore beyond the scope of the receiver's powers. In other words, attachment is not enough to enable a receiver to realise charged property and distribute to the chargeholder, it is necessary to separately consider whether the property is available for enforcement by remaining in the company's patrimony.

In the highly limited circumstances in which subordinate real rights could be obtained without the company's assistance, notwithstanding the receivership, then the position might differ from the transfer of ownership. The fixed security effect of attachment may mean that subsequently created subordinate real rights are subject to the charge. The priority position between real security rights and other subordinate real rights is relatively undeveloped but the principle *prior tempore potior jure* may well apply. And enforcement of the charge *would* be possible due to the property remaining in the patrimony of the company. Thus the property might be realisable unencumbered by the other real rights. These points also extend to an attached charge in liquidation and administration. An alternative position is that a fixed security does not automatically prevail but, instead, only gives the creditor the right to reduce real rights granted in breach of the security conditions. The most obvious example is where a debtor grants a lease, in breach of a standard condition, without the permission of the standard security holder.⁵⁴⁹ The lease will seemingly exist until the security holder successfully reduces it. It may be that other real rights created after the security, such as a liferent or servitude, would not be challengeable by a creditor, as the debtor was permitted to deal with the property in this way. But if the standard conditions are varied to include restrictions on such other real

⁵⁴⁸ 1979 Act, s 17. These could become challengeable transactions if the company entered insolvency, liquidation or administration and the transfer was not for full value.

⁵⁴⁹ *Trade Development Bank v Warriner & Mason* (n 485). Cf Reid (n 485).

rights, this may allow for their reduction too.⁵⁵⁰ If a fixed security creditor could reduce a lease or other real right this would suggest that a chargeholder has this ability too. Yet there must be doubts as to whether an attached charge so closely mirrors eg a standard security to incorporate standard conditions, let alone variations of these. And a chargeholder needs to act through a receiver, administrator or liquidator and these parties do not have any clear mechanism for reducing valid subordinate real rights.

If the “separation” analysis regarding transfer is applied to a *Sharp* scenario, a liquidator could be in a stronger position than a receiver.⁵⁵¹ This is because a receiver, apparently, cannot have property vested in him by virtue of a court application, nor can he register a notice of title, whereas a liquidator can.⁵⁵² And it is unlikely that a chargor can confer a vesting power upon a receiver in the charge instrument, albeit that this is a matter of some complexity. Nevertheless, a receiver can take certain steps to defeat a prospective transferee. If the receiver can be defeated by a party acquiring ownership after attachment, this places emphasis upon the need for the receiver to take control of property as soon as possible. A receiver could transfer ownership to a new purchaser prior to, for example, a disponee registering or an assignee intimating. If property is sold by a receiver before a party completes title, or obtains another real right, those parties do not acquire an interest in the proceeds and will be defeated. However, a new purchaser may be cautious about purchasing from the receiver if it is aware that another party is in a position to complete title and thereby prevail.⁵⁵³ That will be true even if those receiving title from a receiver in good faith are protected.⁵⁵⁴ Such protection will not assist where title has already passed from the company to another party.

⁵⁵⁰ For variations of standard conditions, see *Halliday's Conveyancing*, vol 2, paras 53-07ff.

⁵⁵¹ But a receiver is in a better position in other ways: he has priority over a liquidator (*Manley Petr* 1985 SLT 42) and, in terms of control over enforcement, it is a more advantageous process for a chargeholder.

⁵⁵² See above for liquidation (n 502). The absence of express statutory provision seems to remove these possibilities for a receiver. There is also no express means by which an administrator could have property vested.

⁵⁵³ But this is already even more the case due to *Sharp*. It is also possible, but perhaps unlikely, that a transfer by a receiver could be challenged on the basis of the offside goals rule: eg if there is a pre-existing contract in favour of A to receive property X and then the receiver sells and transfers X to B. The suggestion in *Forth & Clyde* that common law rules do not apply to the exercise of powers by a receiver would suggest that the doctrine will not affect a receiver's acts.

⁵⁵⁴ 1986 Act, s 55(4).

There are also some situations in which a receiver, unlike a liquidator and administrator, does not have the ability to recover property transferred to another by the debtor company. As Bennett states, a “notable omission” regarding the receiver’s powers is the express power to reduce gratuitous alienations, fraudulent or unfair preferences, and extortionate credit transactions, which can only be challenged in a liquidation or administration.⁵⁵⁵ This omission is appropriate as property recovered or payment received by the company following a successful challenge is for the benefit of the general body of creditors, not for the chargeholder in whose interests the receiver is acting.⁵⁵⁶ As such, even if a receiver did have such a power there would be little value in exercising it, as the chargeholder would not directly benefit. Bennett correctly suggests, however, that, in practice, the threat of liquidation may allow a receiver to obtain repayment from a party alleged to have engaged with the company in a challengeable transaction.⁵⁵⁷

It might be wondered whether a floating charge could still be enforced where property is transferred to a third party by a receiver appointed by another chargeholder. Paisley suggests that, although floating charges “invariably” exist over the chargor’s property, it is theoretically possible for land to be transferred to another party, after a charge’s attachment, and yet remain subject to the charge.⁵⁵⁸ He suggests that the circumstances required for enforcement against another’s property would be “bizarre”: a company grants two floating charges, a receiver is appointed under one but not the other and the company is in liquidation, which causes the other charge to attach.⁵⁵⁹ The receiver would sell without the consent of the other chargeholder and without the court’s sanction, leaving the other charge “undischarged and attaching to the property”. But this seems incorrect: why does the other floating charge continue to affect the transferred property rather than provide a lower-ranking claim to the proceeds? And how could a liquidation, which is patrimonially limited to the debtor, extend to property validly sold? Without a satisfactory answer to this, the second charge could never be enforced.

⁵⁵⁵ *Palmer’s Company Insolvency*, para 231. 1986 Act, ss 242-244. Related challenges are also available at common law in the context of insolvency.

⁵⁵⁶ See 63ff for discussion.

⁵⁵⁷ *Palmer’s Company Insolvency*, para 231. But see 62ff as to whether this property will be available to a chargeholder.

⁵⁵⁸ Paisley, *Land Law*, para 2.29.

⁵⁵⁹ *Ibid*, n 95. And see n 551 above.

To some degree, the different treatment given to charges attaching in receivership and liquidation means that, where possible, appointing a receiver was, and is, a means by which a chargeholder obtains self-protection.⁵⁶⁰ Nevertheless, if an attached floating charge is a security under section 61(1)(a) of the 1986 Act, this could stop a receiver from selling property without the consent of a chargeholder and s 61(2) might enable a court to give effect to the respective ranking preferences. Yet s 61 does not seem to prohibit a receiver from selling property even without consent, it just means that the property will remain encumbered by the security if consent (or the court's permission) is not obtained.⁵⁶¹ In strict legal terms, this continued encumbrance is unlikely to help a chargeholder due to the charge's apparent patrimonial restrictions; however, a receiver may cautiously seek consent. If the charge that attached in liquidation was lower ranking, the receivership distribution provisions allow for payment of proceeds to the liquidator to take account of this.⁵⁶² Where a higher-ranking chargeholder appoints an administrative receiver, and a lower-ranking chargeholder cannot, the latter will also not be able to appoint an administrator due to the existence of the administrative receiver. Consequently, the lower-ranking creditor may have to protect its interests by pushing the company into liquidation, which will cause its charge to attach.⁵⁶³

(3) Receivership and the Enforcement of Diligence

One potentially problematic element of separating attachment and enforcement for receivership relates to diligence. Unlike liquidation and administration, receivership itself may not limit the ability of a creditor to execute and/or complete diligence.⁵⁶⁴ Administration places a moratorium on taking diligence enforcement steps.⁵⁶⁵ And, for liquidation, parts of the estate arrested or attached within 60 days prior to liquidation or thereafter, or funds

⁵⁶⁰ Eg a higher-ranking chargeholder will only receive a distribution of moneys ahead of a lower-ranking chargeholder, that has appointed a receiver, if the former also appoints a receiver (1986 Act, ss 56(1) and 60(1)-(2)).

⁵⁶¹ See McKenzie Skene, "Corporate Insolvency", para 161.

⁵⁶² As, after payment to the chargeholder that appointed the receiver, payment may be made to the liquidator – 1986 Act, s 60(2)(c).

⁵⁶³ 1986 Act, s 122(2). Otherwise, the receiver would have no obligation to distribute to them as the charge would not have attached. But a fixed security holder, ranking lower than the unattached charge, could receive a distribution – *ibid*, s 60(2)(b).

⁵⁶⁴ In SLC, *1961 Act Memorandum*, the draft bill contained a clause (2(7)) providing that "no person shall have power to execute diligence on any such part of the property of the company as is attached by the floating charge..."; and see para 30. This provision was omitted from the subsequent report and later legislation.

⁵⁶⁵ Without the consent of the administrator or the court – 1986 Act, Sch B1, para 43(6).

received under the Debtors (Scotland) Act 1987, s 73J(2), require to be handed over to the liquidator.⁵⁶⁶ In receivership there is no moratorium and no provision requiring payment of proceeds by diligence creditors to the receiver. Could a creditor therefore use an arrestment or attachment, or otherwise execute diligence, during the currency of receivership? And if the diligence has been executed, either before or during the receivership, could it be completed while the receivership is ongoing? The significance of this latter point has been minimised by the recent Inner House decision in *MacMillan*, which provides that inhibition, arrestment, and probably any other commonly recognised form of diligence, is effectually executed if it is not rendered ineffective by virtue of proximity to liquidation (see the 60-day rule noted above).⁵⁶⁷

Of course, the receiver can seek to take possession or control of property, or demand the payment of sums due from a debtor of the company, which might preclude the possibility of diligence being completed. Property can also be sold by the receiver and, dependent upon the circumstances, the acquirer takes the property free of the diligence or encumbered by it. Given the wording of the 1986 Act, s 61(1), and the fact a receiver's powers are subject to the rights of those with effectually executed diligence, it seems that the property will remain encumbered if the receiver sells without the consent of the diligence creditor or the court, under s 61. However, if the receiver sells with the court's permission, the property will be freed from the diligence and the diligence creditor will be entitled to a priority payment from the receiver. Separately, the threat of liquidation (or administration) could also be sufficient to stop a creditor either executing or taking the final steps for completion of diligence.⁵⁶⁸ But although these are obstacles, they do not mean that diligence is impossible in a receivership.

The powers of a receiver are subject to the rights of those who have effectually executed diligence on property prior to the receiver's appointment.⁵⁶⁹ This probably means that

⁵⁶⁶ 1986 Act, s 185(1)(a) applying 2016 Act, s 24(6) and (7) with adjustments. See also s 24(2) and (3), the latter of which (combined with 1986 Act, s 185(1)(a)) provides a similar 60-day rule for the vesting of an inhibitor's rights of challenge in the liquidator.

⁵⁶⁷ In *MacMillan* the five-judge First Division disapproved of *Lord Advocate v RBS* and challenged the reasoning in *Iona Hotels*. See also 1986 Act, s 61(1A), which provides that inhibition that takes effect after the creation of a floating charge is not effectual diligence in terms of s 61(1). S 61(1B) provides that arrestment is only an effectual diligence for s 61(1) where it is executed before the floating charge attaches, but this has not been brought into force.

⁵⁶⁸ This threat is well-recognised where the receiver learns that creditors have laid on diligence within 60 days: see Bennett, "Receiver in Scotland" (n 531), paras 27-29 and 27-32.

⁵⁶⁹ 1986 Act, s 55(3)(a).

creditors with such diligence can enforce despite the receivership.⁵⁷⁰ If so, the same issues as for fixed securities above would apply, regarding payment of the proceeds by that creditor to the chargeholder or the receiver. If the receiver realises the property instead, he is required to make payment to, *inter alia*, those with effectually executed diligence, before the relevant chargeholder. This means that the diligence creditor will often suffer no disadvantage by letting the receiver enforce. Confusingly, however, the distribution provisions for receivers seem to provide that a diligence creditor (with effectually executed diligence) *would* lose out to a lower-ranked fixed security holder, if both rank ahead of the floating charge.⁵⁷¹ This might serve as an incentive for self-enforcement by the diligence creditor.

It is assumed that only diligence executed prior to the appointment of a receiver could properly be “effectually executed diligence”. The attachment of a floating charge as if it is a fixed security means that later diligence is subject to the attached charge; priority between fixed securities and diligence is determined according to timing. This means that, for example, any arrestment, attachment or adjudication laid on after the receiver’s appointment would rank behind the floating charge. The precise effect of the diligence does, however, depend upon which attachment mechanism applies and the type of property involved. For example, with money claims the prevailing approach to attachment’s effect would mean that the attached charge, as a deemed assignation in security, would cause a fictionalised transfer. Therefore, arrestment of the property by the chargor’s creditor would not be possible, as the *chargeholder* is not that creditor’s debtor.⁵⁷² But it is unclear whether such diligence is just unsuccessful for floating charge purposes or if it is completely ineffectual.⁵⁷³ By contrast, a *sui generis* approach would allow for the diligence to affect the property but it would rank behind the charge and have to be dealt with outside the receivership.⁵⁷⁴

⁵⁷⁰ The form of enforcement would depend upon the type of diligence. With adjudication, final enforcement requires an action of declarator of expiry of the legal, which can only take place from ten years after an adjudication is created – see Gretton, *Inhibition*, 220f. Given this timeframe, a chargeholder (and the adjudicator) will usually be keen for the receiver to realise and distribute.

⁵⁷¹ 1986 Act, s 60(1). Unless the diligence creditor can somehow claim sums due from the “lower-ranking” secured creditor outside the receivership.

⁵⁷² See *Forth & Clyde*.

⁵⁷³ Eg whether or not it would be effective over property were the property not sold by the receiver and the company subsequently exited receivership.

⁵⁷⁴ As there is no place for it in the distribution of proceeds by the receiver.

It would be strange if the receivership distribution rules allowed for diligence executed *after* the charge's attachment to have ranking priority by being "effectually executed diligence". Some doubt arises on this point, however, because the provision about the powers of the receiver being subject to the rights of those with effectually executed diligence specifically refers to such diligence executed "prior to the appointment of the receiver".⁵⁷⁵ This could be read as implying that the establishment of effectually executed diligence after that appointment is possible but that the receiver's powers will not be subject to the rights of those with such diligence. There is no pre-receivership limitation upon effectually executed diligence in the distribution provisions or the disposal of property provisions, which require a receiver to obtain the consent of a creditor who has executed "effectual diligence", or the court's permission, before selling property.⁵⁷⁶ It would be helpful to have statutory clarification that effectually executed diligence requires execution of diligence *prior to* attachment of a floating charge. The alternative argument, that parties may obtain effectually executed diligence after the appointment of a receiver, would be highly inconvenient for a receiver's work. There could be a race amongst creditors to obtain diligence and ranking priorities would be in a constant state of flux, which would hinder realisation and distribution. Instead, it is much preferable if s 60(1) represents a stable reflection of ranking priorities when the charge attaches.

Even if a diligence is not deemed "effectually executed", including by virtue of being executed after a receiver's appointment, might there be some sort of race between a receiver's realisation of the property and the debtor's completion of the diligence during the receivership process? For example, a party which had arrested property after the attachment of a floating charge could attempt to proceed to furthering following the receiver's appointment. If successful, this would transfer the property to the diligence creditor and thus, potentially, remove it from the reach of the receiver.⁵⁷⁷ But it may not be possible if the charge's attachment has the deemed effect of an assignation in security and thus removes the property from the company's patrimony.⁵⁷⁸ In addition, the receiver can generally rely on the power to

⁵⁷⁵ 1986 Act, s 55(3)(a).

⁵⁷⁶ If the property is to be sold unencumbered: *ibid*, s 61(1)(b). (And see s 61(2) and (8).) The equivalent provision for "security" rights (s 61(1)(a)) expressly refers to those which rank prior to, *pari passu* with, and postponed to, the relevant floating charge.

⁵⁷⁷ If, however, corporeal moveables were being arrested, they would still need to be sold after furthering with proceeds to be paid to the arrester.

⁵⁷⁸ See above and chapter 5. This would not apply if corporeal moveables were being arrested or other forms of diligence were being used.

“take possession of, collect and get in the property” from any person and take proceedings for that purpose.⁵⁷⁹ The property remains the company’s until the diligence is completed. Also, the diligence creditor’s rights are subject to the powers of the receiver, which would justify intervention in, for example, a forthcoming action (following arrestment) or would enable them to stop a sale in implement of the diligence of attachment. A court would no doubt decide against the low-ranking diligence creditor in competition with the receiver, bearing in mind the priority of the receiver’s powers and that party’s remit to distribute to various parties with higher ranking than the diligence creditor.

One particularly difficult issue is identifying what the receiver can do in opposition to the automatic release of funds after 14 weeks⁵⁸⁰ where property has been arrested. Specific circumstances, outlined in the Debtors (Scotland) Act 1987 s 73L, can, however, prevent the release. These include the raising of a multiplepoinding action in relation to the arrested funds,⁵⁸¹ and also where an application is made by certain parties (including the debtor and a third party to whom the funds are due solely or in common with the debtor) to the sheriff for an order recalling or restricting the arrestment under s 73M.⁵⁸² The receiver could claim to be acting on the debtor’s behalf, as agent, or as the party to whom the funds are due. There are only certain grounds of objection justifying an application to the sheriff, most pertinently here that the funds attached are due to the “third party” solely or in common with the debtor.⁵⁸³ Alternatively, the automatic release provisions could be read as part of a diligence creditor’s rights that are subject to the powers of a receiver. Nevertheless, it would be preferable if reliance upon such provisions was not necessary and that there was a clear legislative statement that diligence cannot be completed in a receivership, unless it is effectually executed prior to the receiver’s appointment.⁵⁸⁴

⁵⁷⁹ 1986 Act, Sch 2, para 1.

⁵⁸⁰ Under Debtors (Scotland) Act 1987, s 73J.

⁵⁸¹ S 73L(1)(c).

⁵⁸² S 73L(1)(a).

⁵⁸³ S 73M(4)(c).

⁵⁸⁴ Although the importance of this is receding with the decline in the availability of receivership.

F. ADMINISTRATION

Generally, an administrator “must perform his functions in the interests of the company’s creditors as a whole”.⁵⁸⁵ This is true even if he was appointed by the chargeholder. (In reality, there is, however, often a close relationship between the chargeholder and the administrator.)⁵⁸⁶ Unlike for liquidation and receivership, the primary objective of administration is “rescuing the company as a going concern”.⁵⁸⁷ Only if the administrator thinks it is not reasonably practicable to meet: (i) that primary objective; and (ii) the secondary objective of achieving a better result for the creditors as a whole than would be likely in a winding up;⁵⁸⁸ will the objective of the administration be “realising property in order to make a distribution to one or more secured or preferential creditors”.⁵⁸⁹

Nevertheless, an administrator may deal with the company’s property with any of these objectives in mind, and can dispose of property and distribute to creditors to meet the objectives. In exercising his functions, an administrator acts as the company’s agent.⁵⁹⁰ His powers are consequently powers that might be exercisable by the company (were it not in administration), but with special protections and additions.⁵⁹¹ An administrator “may do anything necessary or expedient for the management of the affairs, business and property of the company”.⁵⁹² He is also required “to take custody or control of all the property to which he thinks the company is entitled”.⁵⁹³ And he has the powers specified in Sch 1 of the 1986 Act. These include powers relating to: taking possession of, collecting and getting in “the property of the company” and selling, hiring out and otherwise disposing of such property.⁵⁹⁴ None of the powers allow for the administrator’s reach to extend to property that has been validly transferred, and which therefore is no longer the company’s property. (Express statutory provision seems necessary for an administrator to deal with property not belonging

⁵⁸⁵ 1986 Act, Sch B1, para 3(2).

⁵⁸⁶ See n 126. And see eg Goode, *Principles of Corporate Insolvency*, paras 11-37ff regarding pre-packaged administrations.

⁵⁸⁷ 1986 Act, Sch B1, para 3(1)(a) and (3).

⁵⁸⁸ *Ibid*, para 3(1)(b).

⁵⁸⁹ *Ibid*, para 3(1)(c) and (4).

⁵⁹⁰ *Ibid*, para 69.

⁵⁹¹ *Ibid*, paras 59ff and Sch 1.

⁵⁹² *Ibid*, para 59(1). See also paras 1(1) and 68.

⁵⁹³ *Ibid*, para 67.

⁵⁹⁴ *Ibid*, Sch 1, paras 1ff. See also *ibid*, Sch B1, paras 70-71; and the discussion at St Clair and Drummond Young, *Corporate Insolvency*, paras 5-79ff, regarding the administrator dealing with property charged by floating charges or encumbered by other securities.

to the company, as there is for property possessed by the company on hire-purchase.⁵⁹⁵) Consequently, it is logical that if the property does not belong to the company when the administrator is exercising these powers,⁵⁹⁶ the administrator has no power over such property.⁵⁹⁷ This poses the question of how can property be validly transferred (except by the administrator) when the company is in administration?

While a company is in administration, neither the company nor its officers may exercise a management power without the administrator's consent.⁵⁹⁸ Given that an administrator has power to deal with property, the implication is that the company and directors do not have such a power and, if they do attempt to transfer property, this will be void.⁵⁹⁹ Yet, as above for liquidation and receivership, it would seem that so long as the debtor company fulfils its obligations relating to transfer before administration, the purported transferee can complete the transfer afterwards. Although administration creates a moratorium in relation to, *inter alia*, enforcing security rights, the re-possession of certain goods in the company's possession, and the institution and continuation of legal processes (including legal proceedings and diligence) against the company or its property,⁶⁰⁰ there is no identifiable restriction on a party completing a transfer by, for example, registration or intimation.

Consequently, as for liquidation and receivership, there is not a legislative mechanism for the re-transfer of property from a third party that has validly acquired ownership after the commencement of administration. The attachment of a floating charge (even if deemed a fixed security) does not, by itself, stop property from being transferred. And, in administration, the charge is unlikely to have even attached when the transfer of the property occurs. Administrators, like liquidators (and probably receivers), due to their status as "agents" (or representatives), can only sell property which is owned by the debtor company when the sale

⁵⁹⁵ 1986 Act, Sch B1, paras 43(3), 72, 114.

⁵⁹⁶ But he would have powers over eg a contractual right to obtain property or a subordinate real right: that is because these rights are property that belong to the company.

⁵⁹⁷ Parties in good faith transacting with the administrator do, however, have protection if the administrator is acting beyond his powers (1986 Act, Sch B1, para 59(3)). But this is unlikely to assist where the administrator is seeking to sell property owned by another.

⁵⁹⁸ Ibid, para 64(1). Para 64(2)(a): "'management power' means a power which could be exercised so as to interfere with the exercise of the administrator's powers".

⁵⁹⁹ See McKenzie Skene, *Insolvency*, 174; McKenzie Skene, "Corporate Insolvency", para 117; St Clair and Drummond Young, *Corporate Insolvency*, para 5-61.

⁶⁰⁰ 1986 Act, Sch B1, paras 42f.

is to take place. If one of these parties is allowed to recover property, then this must be on the basis that the transferor, rather than the transferee, is actually the owner of the property, or that the transfer itself is voidable at the instance of the company (or its representative) and the transfer is reduced accordingly.

An approach to the floating charge that is as consistent as possible across the different enforcement methods is desirable. Using an analysis which combines the rules of Scots property law and the inherent limitations of the enforcement processes of the floating charge allows for more doctrinally palatable and coherent outcomes and a unified law of floating charges. The statutory provisions do, however, differ in certain respects, and this has contributed to the courts interpreting the operation of the floating charge in varying ways dependent upon the enforcement method used.⁶⁰¹ But the wider the perceived differences between the varying forms of enforcement, the greater the fragmentation of floating charges and the more uncertainty there is for both the future development and application of the law.

G. A REAL RIGHT?

(1) Real Right Indicators and Patrimonial Limitations

The foregoing discussion regarding enforcement of floating charges, which has identified potential limitations on the effectiveness of the charge with respect to transferred property, requires us to examine afresh the question of whether a floating charge is a real right. As mentioned in the previous chapter, a floating charge is widely considered to confer a real right upon attachment. Certainly, an attaching charge does have “real effect” in certain respects within the crucial enforcement context. The *attached property* is used for realisation and the proceeds are distributed to the chargeholder. In general terms, attachment also gives a ranking preference against other secured creditors and unsecured creditors. And the charge may have priority over other real rights created after attachment too. Furthermore, if there is a negative pledge, the charge ranks from its creation and thereby prevails against later-created voluntary real rights in security and/or floating charges. A right which prevails over the general body of creditors in an insolvency, by virtue of an interest in particular property, will often be

⁶⁰¹ Eg in relation to acquirenda: see 57ff. And see eg *Lord Advocate v RBS*; and *Taylor Petr* (n 400) at 413f, for assertions of differences between receivership and liquidation.

considered a real right. The relatively favourable treatment given to the floating charge in this context bolsters its case for such labelling.

The charge's "realness" is, however, circumscribed in various respects involving enforcement, which undermines the argument that it is a real right. This is demonstrated when we consider a number of other indicators of a real right in security.⁶⁰² One such indicator is that the right prevails, as regards the property, against unsecured creditors. For the floating charge, the picture is mixed: it ranks ahead of unsecured creditors but *behind* preferential creditors (a special category of unsecured creditors); and, since the introduction of the 2002 Act, a proportion of attached assets (the prescribed part) is ring-fenced for unsecured creditors.⁶⁰³

Another indicator is that a secured creditor has the ability itself to enforce against the property.⁶⁰⁴ (This may be considered a particular manifestation of the general real right characteristic of direct power over the object of the right.)⁶⁰⁵ The self-enforcement indicator is only applicable to a floating charge in the widest sense. As we have seen, true self-enforcement is not possible. Enforcement relies upon an administrator, liquidator or receiver, each of which acts as an agent (representative) of the debtor company in relation to that party's property. (And the appointment of an administrator may not even lead to the attachment of the charge.)

A further indicator is that a purported real right affects third party acquirers of the property. The attached floating charge does generally have third party effect in relation to property, while that property remains in the chargor's patrimony. However, third parties who validly acquire property before the charge's attachment are unaffected and this may also be the case for post-attachment acquisition, even if we put the implications of *Sharp* to one side. If the

⁶⁰² For some discussion of real right factors, see *Report on Diligence on the Dependence* (n 428), paras 9.6ff; and Gretton, "Concept of Security".

⁶⁰³ For the prescribed part see 1986 Act, s 176A (added by the 2002 Act, s 252) and Insolvency Act 1986 (Prescribed Part) Order 2003/2097. In *Thorniley v HMRC* [2008] EWHC 124 (Ch) it was held that a floating charge creditor cannot also claim in the prescribed part with respect to any unsecured balance.

⁶⁰⁴ This, however, is just an indicator. A system could be constructed in which security rights can only be enforced by diligence or through insolvency. See eg Steven, *Pledge*, paras 8-04ff, regarding the historical enforcement of pledge in Scots law using diligence. The landlord's hypothec was formerly principally enforced by the diligence of sequestration for rent. However, it has been suggested that the abolition of that diligence and accompanying changes (2007 Act, s 208) mean that the hypothec could now be a preference right: see eg AJM Steven, "Goodbye to Sequestration for Rent" 2006 SLT (News) 17 at 17f, writing prior to the Act's passing.

⁶⁰⁵ L van Vliet, *Transfer of Movables in German, French, English and Dutch Law* (2000), 27f.

charge is being enforced, this must be through the liquidator, receiver or administrator, and property they transfer is released from the charge. And, in the instances that it is possible for transfer to validly take place after attachment, outside the enforcement context, the patrimonial limitations of the enforcement of the charge suggest that such property is no longer affected.⁶⁰⁶ Thus, even if a floating charge is a real right, the absence of enforcement except within the chargor's patrimony, through liquidation, receivership or administration, suggest that the charge cannot be considered a typical real right in security.⁶⁰⁷

The patrimonial limitations of the floating charge are also demonstrated in its relationship with trust property. The emerging consensus in Scots law is that trust property is held by the trustee(s) in a special patrimony.⁶⁰⁸ If property is held by a chargor in trust, that property is apparently not attached by a floating charge granted over the whole of the chargor's property.⁶⁰⁹ It is, therefore, logical to conclude that a floating charge only covers property in the chargor's private patrimony. And even if a charge can technically be granted over trust property, there are inherent patrimonial restrictions from an enforcement perspective. Trust property is excluded from the liquidation of a company, and the same applies to receivership and administration, as sequestration is the only recognised insolvency process for trust estates.⁶¹⁰ The latter is not a process in which the floating charge attaches nor which allows for the charge's enforcement.

⁶⁰⁶ And under the current law it may not even attach to the property, if beneficial interest has already passed.

⁶⁰⁷ But it could be argued that using these processes often negates any need for direct self-enforcement.

⁶⁰⁸ See eg GL Gretton, "Trust and Patrimony" in HL MacQueen (ed), *Scots Law into the 21st Century: Essays in Honour of WA Wilson* (1996); KGC Reid, "Patrimony Not Equity: The Trust in Scotland (2000) 8 ERPL 427 updated and republished in R Valsan (ed), *Trusts and Patrimonies* (2015) 110; GL Gretton, "Trusts without Equity" (2000) 49 ICLQ 599; G Gretton, "Up there in the *Begriffshimmel?*" in L Smith (ed), *The Worlds of the Trust* (2013). As Reid at 123f notes, in Scotland "the central role of patrimony has been accepted by legal scholars, by the Scottish Law Commission, and, increasingly, by the courts, and can now be regarded as 'clearly established'."

⁶⁰⁹ *Tay Valley Joinery Ltd v CF Financial Services Ltd* 1987 SLT 207.

⁶¹⁰ 2016 Act, s 6(3); *Turnbull v Liquidator of Scottish County Investment Co* 1939 SC 5; *Smith v Liquidator of James Birrell Ltd (No 2)* 1968 SLT 174; and *Gibson v Hunter Home Designs Limited* 1976 SC 23. See also *Bank of Scotland v Liquidators of Hutchison, Main & Co Ltd* 1914 SC (HL) 1; and *St Clair and Drummond Young, Corporate Insolvency*, para 12-01. For recognition of the enforcement difficulties for a floating charge regarding trust property, see SLC, *Registration Report*, paras 2.31f.

(2) Real Right or Preference Right?

The overall picture then is of an interest that does not fit into the existing real right in security mould in Scots law. It cannot be said that the absence of one or more of the above indicators renders a right non-real; however, the cumulative effect for the floating charge may have this effect. The charge combines some elements of real security with a voluntary insolvency or patrimonial preference. Even the fact that the entitlement conferred by a floating charge relates to specific attached property, and distribution arises from the proceeds thereon, is not limited to real rights. Other systems allow for preference claims to exist for all property in the insolvent's estate (as is more familiar in Scots law) or to specific property. In the Netherlands, these are referred to respectively as general privileges and special privileges.⁶¹¹ And, in that system, although the general rule is that secured creditors have priority over preference claims, some of the latter rank ahead of real rights in security by specific provision.⁶¹² As Goudy notes, Scots law has also allowed certain "privileged debts" to prevail against real securities.⁶¹³ On this basis, a floating charge could be either a preference or a real security right.

One might suggest that a difference between real rights and preference rights is that the former confer actions *in rem* (ie the rights are exercisable directly in relation to property), and are thereby enforceable against anyone, whereas the latter do not give this.⁶¹⁴ Preference rights are enforceable in the estate (or patrimony) of the debtor and against the party administering the debtor's estate. And they usually only give a priority right to a creditor in an insolvency (or related) process.⁶¹⁵ In this respect, and because of what has been discussed in this chapter (and elsewhere), the floating charge, at least in practical terms, could be deemed a special kind of preference right rather than a real right.

Yet describing it in these terms does not present the full picture and may not give appropriate regard to the weight of judicial authority referring to the charge as a real right.⁶¹⁶ The

⁶¹¹ Art 3:278(2) of the Dutch Civil Code. And see D Faber and N Vermunt, "National Report for the Netherlands" in D Faber et al (eds), *Ranking and Priority of Creditors* (2016), ch 12, especially at paras 12.07 and 12.68ff.

⁶¹² Art 3:279; and see Faber and Vermunt (n 611), para 12.70.

⁶¹³ Goudy, *Bankruptcy*, 539. He describes these as functioning "as regards moveable estate like a universal hypothec".

⁶¹⁴ See eg the position in Quebec: *Hull (Ville de) v Tsang* [1998] RDI 343 (Queb CM) at 345 (para 16); L Payette, *Les Sûretés Réelles dans le Code Civil du Québec*, 2nd edn (2001), para 209.

⁶¹⁵ But see eg Dutch law where privileges apparently apply wherever there is recourse by a creditor against a debtor, and not just in insolvency: Arts 3:278ff of the Dutch Civil Code.

⁶¹⁶ Albeit that the precise extent of referring to the charge as a real right in each case can be debated.

attachment effect does mean that the floating charge is deliberately cloaked as a real right, at least in particular contexts. And, unlike the present conception of preference rights in Scots law, a floating charge is voluntarily granted for security purposes, confers rights in particular property (upon attachment), ranks against other rights as if it were a real right and has an existence outside the insolvency context, which gives its holder special powers to bring about enforcement processes.

To be incorporated into the existing *numerus clausus* category of real rights in security, in general terms, would, however, require an expansion or re-characterisation of that category. But the same is true of our current notion of preference rights. Alternatively, the charge may be best described as a *sui generis* hybrid or composite of real right and patrimonial preference.⁶¹⁷

⁶¹⁷ And see the discussion at 117ff.

CHAPTER 7

THE FLOATING CHARGE AND HERITABLE PROPERTY

A.	INTRODUCTION	161
B.	FLOATING CHARGE AND HERITABLE PROPERTY – BACKGROUND	162
C.	ATTACHMENT AND HERITABLE PROPERTY – GENERAL	165
D.	<i>SHARP v THOMSON</i>	167
(1)	The Facts	167
(2)	The Decisions.....	167
(3)	Commentary	172
(4)	The Ratio’s Extent.....	176
(5)	“Property and Undertaking”	186
(6)	Beneficial Interest	190
E.	ATTACHMENT AND HERITABLE SECURITIES	194
(1)	Standard Security	194
(2)	Bond and Disposition in Security.....	195
(3)	<i>Ex Facie Absolute Disposition in Security</i>	195

A. INTRODUCTION

Much of the attention given to the relationship between floating charges and property has focused upon heritable property.⁶¹⁸ In this context, heritable property principally means land, as a direct property object. Therefore, when reference is made to the floating charge attaching to heritable property, this should usually be understood as attachment to the ownership of land.⁶¹⁹ The present chapter will include consideration of when heritable property becomes attachable and unattachable by a charge. The most notable, and controversial, of all floating charge cases in Scots law, *Sharp*, concerned this issue and will be analysed in detail.

⁶¹⁸ Gretton (2003) (n 8) at 319, states that the major difficulties arising from the floating charge in Scots law have arisen “disproportionately” as regards heritable (immoveable) property.

⁶¹⁹ If the chargor instead held other heritable property eg a standard security or a lease or rights in missives, then attachment would be described as being to the standard security, lease or rights in missives. Some aspects of incorporeal heritable property will be dealt with in chapter 9.

The other major component of this chapter will be an examination of the attachment of the floating charge where property is subject to heritable security. Before the introduction of the standard security in 1970, it was possible to create different forms of heritable security: most notably, the bond and disposition in security and the *ex facie* absolute disposition qualified by back letter or agreement. The nature and understanding of these securities raises interesting issues about the intended operation of the floating charge and its interaction with property and heritable securities.

B. FLOATING CHARGE AND HERITABLE PROPERTY – BACKGROUND

The LRCS project that led to the introduction of the floating charge was originally limited to the reform of security over moveable property.⁶²⁰ However, this remit was expressly expanded to include consideration of not only whether a floating charge-type security should be introduced but also the types of property which ought to be chargeable. The LRCS was particularly keen to examine whether the floating charge should be made available over heritable property. Professor Halliday was therefore co-opted to the project sub-committee to give consideration to conveyancing difficulties that might arise.⁶²¹

Some respondents to the LRCS's consultation, such as the Society of Writers to Her Majesty's Signet and the Law Society of Scotland, proposed that heritable property (and certain other property) should not be included within the scope of the floating charge.⁶²² The other respondents did not recommend restrictions and the Council of Scottish Chambers of Commerce expressly favoured following the scope of the floating charge in English law, thus allowing for coverage of all property types.⁶²³ The LRCS accepted that all forms of property, including heritable property, should be chargeable.⁶²⁴ They justified this by noting that if certain property was excluded, then proceeds from the sale of property subject to a floating charge could be invested in excluded property and this would diminish the value of floating

⁶²⁰ *Eighth Report*, para 1.

⁶²¹ NRS AD61/55 – letter from WA Cook, Biggart, Lumsden & Co, to JH Gibson, Lord Advocate's Chambers, dated 10 March 1959; *Eighth Report*, ii.

⁶²² *Eighth Report*, para 27.

⁶²³ *Ibid*, paras 28-29.

⁶²⁴ *Ibid*, para 30.

charges. Furthermore, the LRCS added that in commercial law, “unless there is good reason to the contrary, it is desirable that the law of England and Scotland should be the same”.⁶²⁵ English law permitted, and continues to permit, a floating charge operating as a universal security over present and future property.⁶²⁶

The 1961 Act therefore stated that it was competent in Scots law for a company to create a floating charge in favour of a creditor “over all or any of the property, heritable and moveable, which may from time to time be comprised in its property and undertaking”.⁶²⁷ In the 1972 Act, the specific mentions of heritable and moveable property were removed, leaving the simple reference to property.⁶²⁸ This is still the case in the current legislation.⁶²⁹ The separate references to heritable and moveable property were no doubt considered superfluous.

The 1961 Act also allowed floating charges to be effective over heritable property without the necessity of recording in the General Register of Sasines (GRS).⁶³⁰ This was radical, as the creation of existing security rights in heritable property (as well as the creation and transfer of certain other types of real right) required recording in the GRS, a public register. It is therefore not surprising that, during the Bill’s parliamentary passage, the Keeper of the Registers of Scotland expressed concern.⁶³¹ The Keeper emphasised the importance of recording to create real rights in land and warned that creating security rights without recording would mean the public could no longer transact on the “faith of the records”. Although he recognised the difficulties of recording floating charges in the GRS, he suggested a more acceptable course would be to complete a floating charge for heritable property by recording a conveyance to trustees for the debenture holders.⁶³² The meaning of this proposal is not wholly clear, particularly in the absence of trustees acting for chargeholders. Further recording would seemingly be required whenever charged property was disposed of or new property was acquired and fell within the charge’s ambit.⁶³³

⁶²⁵ Ibid.

⁶²⁶ See eg R Calnan, *Taking Security*, 3rd edn (2013), paras 4-01ff.

⁶²⁷ 1961 Act, s 1(1). There were no separate references to corporeal and incorporeal property.

⁶²⁸ See s 1(1) of the 1972 Act.

⁶²⁹ 1985 Act, s 462(1).

⁶³⁰ 1961 Act, s 3.

⁶³¹ NRS HH41/1434 – letter from G Black, Registers of Scotland, to NE Sharp, Scottish Home Department, dated 11 January 1961.

⁶³² Ibid.

⁶³³ See NRS HH41/1434 – letter from NJP Hutchison, Scottish Home Department, to HHA Whitworth, Scottish Home Department, dated 25 January 1961.

In the *Eighth Report*, the following issues (that would arise if recording in the GRS was necessary) were given as reasons for rejecting recording: the requirement for examination of titles of all of a company's heritable properties, the need for descriptions of all the properties, and the necessity of registering further notices when the company acquired new property.⁶³⁴ In correspondence with the Keeper, more details were provided as to why there was to be no recording in the GRS. A company would be permitted to transact with its property prior to attachment and, until then, there would be no reason why the GRS should show a floating charge over any property.⁶³⁵ A simple course was to be adopted, whereby the grantor should have as much proprietary liberty as possible. There was to be no requirement for complicated registrations involving changing assets, which might give the impression of an encumbrance which did not reflect the practical reality of a non-attached floating charge. The floating charge would only be effective upon attachment, when the company went into liquidation and, because the liquidation would operate like an adjudication,⁶³⁶ it was considered immaterial that there would be no reference to the charge in the record of the property in question. (This is despite the fact that an adjudication would be registered in the GRS (and now in the Land Register) against a particular property.) In addition, a search in the charges register would display whether or not a floating charge covered the property.⁶³⁷

A floating charge, before attachment, is in some ways comparable to an inhibition, as it can apply to all of a party's heritable property at a given time and, just as an inhibition is registered in a personal register, the Register of Inhibitions and Adjudications (RoI), a floating charge is registered against the chargor company in the charges register. In the *Eighth Report* it was actually considered "practicable" to register a notice of a floating charge in the RoI; however, because a new notice would need to be registered every five years, there was an apparent

⁶³⁴ *Eighth Report*, para 49. In the Scottish Standing Committee, 20 June 1961, cols 20-21, Forbes Hendry MP noted the inherent difficulties in registering a floating charge against individual properties, especially if the charge was registered before property "came into the possession of the company". The use of "possession" is odd, as, in the same passage, Hendry seems to equate possession with the company having the ability to sell the heritable property and the property falling into that company's winding up (both of which would depend upon ownership instead).

⁶³⁵ NRS HH41/1434 – letter from JH Gibson, Lord Advocate's Chambers, to G Black, Registers of Scotland, dated 13 January 1961.

⁶³⁶ It is possible to read the relevant wording as if the *charge* was to attach like an adjudication, but it is more likely that Gibson was referring to liquidation's effect, given the existence of (the then-applicable) 1948 Act, s 327(1)(b).

⁶³⁷ NRS HH41/1434 – letter from Gibson to G Black (n 635).

danger of this being overlooked and so the idea was rejected.⁶³⁸ Therefore, registration in the charges register alone was the chosen option.

Since its inception in Scots law, the floating charge has been available over heritable property despite the absence of registration in the GRS, and later the Land Register.⁶³⁹ Although specific consideration was given to heritable property during the floating charge's introduction, not least as a result of co-opting Professor Halliday to examine conveyancing matters, it might be queried if there was adequate consideration and also whether the interpretation of the background law of heritable property was correct. Professor Wilson rightly doubted whether the 1961 Act took into account "all the complexities of the Scottish conveyancing system in general and of the form of security known as the *ex facie* absolute disposition in particular."⁶⁴⁰

C. ATTACHMENT AND HERITABLE PROPERTY – GENERAL

Heritable property is attachable when it enters and remains within the "property and undertaking" of the chargor and becomes non-attachable when it leaves and remains outside that company's "property and undertaking". The potential approaches to the meaning of the relevant statutory provisions have been discussed in detail elsewhere.⁶⁴¹ An example will help to explain the implications of these approaches for heritable property. A Ltd grants a floating charge over all the property in its property and undertaking to B Bank. Meanwhile, C Ltd grants a floating charge in the same terms to D Bank. Next, A Ltd wishes to sell land to C Ltd.⁶⁴²

⁶³⁸ *Eighth Report*, para 49. Interestingly, when the SLC were examining the possibility of introducing receivership to Scots law, consideration was given to requiring a receiver's appointment to also be registered in the RoI – SLC, *1961 Act Memorandum*, para 27. This was rejected for a number of reasons – SLC, *1961 Act Report*, para 53.

⁶³⁹ The current provision is 1985 Act, s 462(5). This was preceded by the 1972 Act, s 3.

⁶⁴⁰ WA Wilson, "The Companies (Floating Charges) (Scotland) Act 1961" 1962 JBL 65 at 66.

⁶⁴¹ See 93ff.

⁶⁴² This example will be used at various points throughout this chapter.

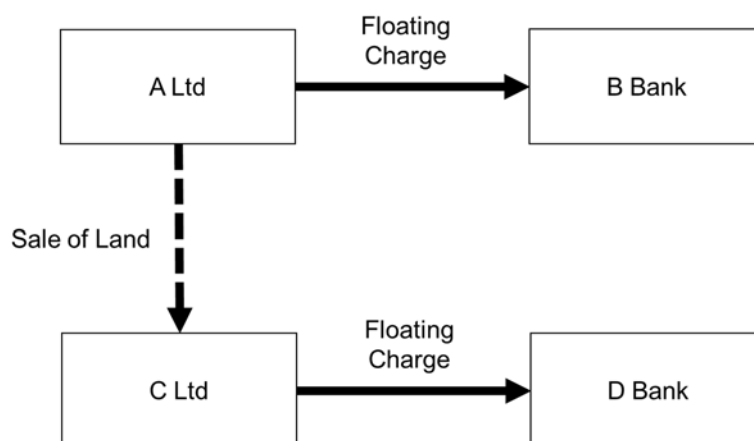

If, by the time B Bank's charge attaches, A Ltd has only concluded missives with C Ltd, attachment will be to A Ltd's right of ownership and to personal rights it has against C Ltd.⁶⁴³ If D Bank's charge attaches at this stage it will do so to C Ltd's personal rights under the missives, including the right to obtain a disposition and warrandice rights relating to title. This is the position under a full ownership attachment approach, but also seems to apply under certain variations of limited ownership and full equitable approaches to attachment.⁶⁴⁴

The most certain analysis, and the one which best fits the floating charge with property law,⁶⁴⁵ is to tie the possibility of attachment only to property owned by the chargor (which can be expressed as the rights, personal and real, held by that party). Under this full ownership (rights-based) approach, B Bank's charge will attach to A Ltd's ownership (and any personal rights against C Ltd) up until the point at which ownership is transferred to C Ltd. This transfer will occur upon C Ltd registering a valid disposition in the Land Register.⁶⁴⁶ Only from this point can D Bank's charge attach to C Ltd's ownership. Until registration, if D Bank's charge attaches it will only do so to personal rights held by C Ltd relating to such heritable property. This approach could be simply applied to all types of heritable (and non-heritable) property.⁶⁴⁷ And it would avoid many of the difficulties inherent in alternative approaches. However, *Sharp* shows that this analysis is presently not applicable in Scots law, at least for the sale of

⁶⁴³ It is notable that the charge attaches to the heritable property being sold *and* personal rights against the purchaser at this stage. However, ultimately, the land will be transferred and the charge will only attach to personal rights to payment or to the money paid.

⁶⁴⁴ Again, see 93ff for these approaches.

⁶⁴⁵ This is particularly true when *Sharp* is compared with *Burnett's Tr.*

⁶⁴⁶ 2012 Act, s 50(2).

⁶⁴⁷ As it would involve attachment to any rights, personal and/or real, held by the chargor.

heritable property where the seller enters receivership. Consequently, ownership is not (always) the determinant as to whether attachment takes place. Instead, the House of Lords created much doubt as to when heritable (and other) property is attachable by a floating charge; and the current law seems to support a limited ownership attachment or full equitable attachment approach.

D. SHARP v THOMSON

(1) The Facts

Albyn Construction Ltd (“Albyn”) granted a floating charge on 2 July 1984 “over the whole of the property... from time to time... comprised in [its] property and undertaking” and the charge was registered on 16 July 1984. Nearly five years later, a brother and sister concluded missives (dated March and May 1989) to purchase a flat from Albyn. The date of entry was 14 April 1989. However, the disposition was not delivered until 9 August 1990. The following day receivers were appointed and the floating charge attached. The disposition was not recorded in the GRS until 21 August 1990. The key issue was whether or not the floating charge attached to the flat,⁶⁴⁸ and, therefore, whether the receivers could realise the flat and distribute the proceeds.

(2) The Decisions

(a) Outer House and Inner House

At first instance, the Lord Ordinary (Penrose) found in favour of the receivers.⁶⁴⁹ The Inner House reached the same decision.⁶⁵⁰ In the Outer House and Inner House, the principal focus for counsel and judges was property law. It was held that: there was no form of intermediate right between a personal right and a real right; a party with an unrecorded disposition had only a personal right; Scots law had a principle of unititularity; and a floating charge was equated with fixed security in the event of attachment, and therefore functioned like a standard security

⁶⁴⁸ According to 1986 Act, s 53(7).

⁶⁴⁹ *Sharp v Thomson* 1994 SC 503.

⁶⁵⁰ *Sharp v Thomson* 1995 SC 455.

for heritable property (and such a security could have been granted in the circumstances).⁶⁵¹ Consequently, the floating charge attached to Albyn's right of ownership in the flat, upon receivership, and the purchasers' completed title was encumbered by the floating charge and the property was subject to the joint receivers' powers.

The defenders' principal argument in the Outer House and Inner House was that upon delivery of a disposition there passed a "beneficial interest in the form of an inchoate or incomplete right of property to the disponee".⁶⁵² Counsel contended too that there was a distinction between the term "property" in the floating charges legislation⁶⁵³ and completed feudal title. And the defenders also argued in the Inner House that "property and undertaking" should be given a purposive commercial interpretation, limited to assets deployed for business activities in accordance with the stated objects in the company's memorandum.⁶⁵⁴ Like the other arguments, this one was also rejected by the court. Lord Hope suggested that the only conclusion from a purposive approach was that there was an intention to give Scottish companies the widest scope possible for creating a floating charge over their property. Reference was also made to the historical development of the floating charge in England and to the broad interpretation given to property and undertaking in *Re Panama*.⁶⁵⁵ Lord Hope's reasoning was also consequentialist; he highlighted some of the complexities (for heritable and moveable property) that would arise from the defenders' arguments.⁶⁵⁶

In reaching his decision, Lord Hope referred to an article by Professor Wilson prophesying conveyancing problems involving the floating charge.⁶⁵⁷ Wilson foresaw that the purchaser of heritable property would be affected by attachment of a seller-granted floating charge (in a liquidation), if attachment occurred before the recording of the disposition. It was suggested that Wilson's observation was based on the assumption that property remained with the seller until the disposition was recorded.

⁶⁵¹ See *ibid* per LP Hope at 460ff; per Lord Sutherland at 481ff; and per Lord Coulsfield at 486ff. Lord Hope's opinion has been described as "the most important analysis of the principles of land transfer to be given in the [twentieth] century": KGC Reid, "Jam Today: *Sharp* in the House of Lords" 1997 SLT (News) 79 at 84.

⁶⁵² See per LP Hope at 461.

⁶⁵³ In eg 1985 Act, s 462(1) and 1986 Act, s 53(7).

⁶⁵⁴ See at 475f.

⁶⁵⁵ Where undertaking was interpreted to include future property of the company (see 83ff above): LP Hope at 477.

⁶⁵⁶ At 477f.

⁶⁵⁷ At 462. WA Wilson, "Floating Charges" 1962 SLT (News) 53 at 55.

The Inner House opinions, especially Lord Hope's, are in many respects well-reasoned, doctrinally acceptable and fit the floating charge within wider Scots law. And, although Lord Hope noted the potential unfairness of the decision in policy terms, he expressed the view that it was the legislature's role to make appropriate changes.⁶⁵⁸

(b) House of Lords

The House of Lords in *Sharp*, however, reversed the First Division's decision and held that the floating charge had not attached.⁶⁵⁹ The substantive opinions were given by Lords Clyde and Jauncey of Tullichettle. The other judges concurred with both, which is problematic given the differences in the two opinions.⁶⁶⁰ The arguments of the defenders, at this stage, were more focused upon statutory construction than general property law and this seems to have contributed to their success (particularly with Lord Clyde).

Lord Jauncey relied upon non-floating charge authority to decide that heritable property attached by a floating charge⁶⁶¹ is beneficial interest, and not "bare title" without such interest.⁶⁶² He asserted that "property" is not a technical or defined expression and "property and undertaking" has to be construed in a "practical", "realistic", "commonsense" and contextual way.⁶⁶³ In his view, the "ability to grant deeds in fraud of the disposition... did not amount to a right of property".⁶⁶⁴ And there was nothing within the legislation which suggested a receiver could do what Albyn could not.⁶⁶⁵ This, however, overlooks the fact that a receiver, although an agent as regards the company's property, is not necessarily bound by the company's personal obligations. The existence of personal creditors also does not override the priority of a secured creditor, and a charge attaches as if it were a "fixed security".

Lord Clyde, by contrast, suggested he was not challenging the First Division's analysis of basic property law principles.⁶⁶⁶ He remarked upon the lower courts construing the floating

⁶⁵⁸ At 481.

⁶⁵⁹ The appellants were the second defenders, the Woolwich Building Society, who had obtained a standard security from the purchasers.

⁶⁶⁰ See eg KGC Reid, "Equity Triumphant: *Sharp v Thomson*" (1997) 1 EdinLR 464 at 465.

⁶⁶¹ Under 1986 Act, s 53(7).

⁶⁶² At 74.

⁶⁶³ At 76f.

⁶⁶⁴ At 77.

⁶⁶⁵ At 77.

⁶⁶⁶ At 80.

charge against the background law of heritable securities and property but, instead, adopted a floating charge-centric analysis based upon the construction of the charge's terms and the echoed statutory wording.⁶⁶⁷

According to Lord Clyde, the intention to bring commercial benefits (available in England) to Scotland, by introducing the floating charge, must have meant that Parliament intended the charge's effect to coincide with its effect in England; and the English charge would not prevail in the circumstances of the case.⁶⁶⁸ Certainly, there was a desire for a security device which operated in an equivalent way to the English floating charge: a non-possessory security available over all the debtor's property (including future property), which allowed the debtor to continue to freely trade until attachment. However, there was also an awareness that this was to function against the different background of Scots law, and, where possible, the terminology used in the legislation ought to be interpreted within its Scottish context. Notably, TB Smith, in his appendix to the *Eighth Report*, emphasised the potential compatibility of the floating charge with Scots law's Civilian heritage but warned against any attempt "to import the technicalities of English Equity jurisprudence".⁶⁶⁹ Although Lord Clyde considered the principles of the floating charge to sit "uneasily" within Scots law,⁶⁷⁰ he, nevertheless, adopted an interpretation further at odds with that system, when more integrated approaches were available.

Lords Clyde and Jauncey were both heavily influenced by the apparent unfairness of the factual situation; if the floating charge attached, the receiver could use the "sold" subjects *and* the money paid by the purchaser to help satisfy the debt due to the chargeholder.⁶⁷¹ Policy-based reasoning was therefore a major component in the decision. There is merit in preferring the disponee in policy terms, but it is possible to overstate the benefits accruing to a chargeholder, as the price paid by a disponee may have been dissipated by the time the floating charge attaches.⁶⁷² Furthermore, the circumstances in the case were unusual and contrary to

⁶⁶⁷ At 79f.

⁶⁶⁸ At 82. But see R Goode, "Commercial Law and the Scottish Parliament" 1999 SLPQ 81 at 89f.

⁶⁶⁹ *Eighth Report*, 14. In Smith, *Short Commentary*, 474f, the content of his Historical Note is repeated, in substantially the same terms, and he notes that "no attempt was made to incorporate the technicalities of English equity jurisprudence" when the charge was introduced.

⁶⁷⁰ Especially the charge's attachment without registration: Lord Clyde at 82.

⁶⁷¹ See eg per Lord Jauncey at 70 and per Lord Clyde at 82f.

⁶⁷² Regarding the depletion of assets in an estate, see eg *Gibson* (n 610) per Lord Cameron at 30.

normal practice.⁶⁷³ The floating charge *was* registered in the charges register and the purchasers knew they were buying property encumbered by a charge. Their solicitors failed to obtain a letter of non-crystallisation but proceeded with the transaction in spite of this.⁶⁷⁴ Is the situation so much more unfair than where a purchaser is tardy in registering a disposition and therefore loses out to a trustee in sequestration or liquidator who obtains title? And, as noted below, the court's decision only gives protection to the disponee in certain circumstances and other means could have been used to achieve the same result.

(c) *Burnett's Tr v Grainger*

It is necessary to mention here the non-floating charge case of *Burnett's Tr*. The facts were similar to *Sharp*; a seller had delivered a disposition to the buyers, who had paid the price and taken entry. Months later, the seller, an individual, was sequestrated but the disposition in favour of the buyers had not been recorded. The trustee in sequestration proceeded to record and did so before the buyers recorded their disposition. The Sheriff Principal perceived himself to be bound by *Sharp*.⁶⁷⁵ But the Inner House could not ascertain an obvious ratio from *Sharp* and therefore interpreted it as narrowly as possible and distinguished it, deciding in favour of the trustee.⁶⁷⁶ The House of Lords upheld the Inner House's decision and, although they did not overrule *Sharp*, they limited its ratio, principally to the law of floating charges.⁶⁷⁷

It might be wondered why the House of Lords did not overturn *Sharp*, especially since Lord Hope sat as a judge in *Burnett's Tr*.⁶⁷⁸ An obvious answer is that counsel for the respondent

⁶⁷³ See eg Reid (n 660) at 468; and GL Gretton, "The Integrity of Property Law and of the Property Registers" 2001 SLT (News) 135 at 135f.

⁶⁷⁴ See per Lord Clyde at 78.

⁶⁷⁵ 2000 SLT (Sh Ct) 116. See eg SC Styles, "Sharp Pains for Scots Property Law: The Case of *Burnett's Tr v Grainger*" 2000 SLT (News) 305; R Rennie, "To *Sharp v Thomson* – an Heir" 2000 SLT (News) 247.

⁶⁷⁶ 2002 SC 580.

⁶⁷⁷ Although Lords Hoffmann and Hobhouse followed the Scottish judges, Lords Hope and Rodger (as well as Bingham of Cornhill), they expressed dissatisfaction with the legal position (see n 702 below). GL Gretton, "Ownership and Insolvency: *Burnett's Trustee v Grainger*" (2004) 8 EdinLR 389, discusses the various theories regarding delivery of a disposition and notes, in light of *Burnett's Tr*, that Lord Jauncey's attempt to introduce an English idea of beneficial interest has failed. For discussion of the post-*Burnett's Tr* position for the transfer of ownership and insolvency law, see eg GL Gretton, "Insolvency Risk in Sale" 2005 JR 335.

⁶⁷⁸ Lord Hope was actually a member of the House of Lords (as a replacement for the retiring Lords Jauncey and Keith) when *Sharp* was heard but could not sit on an appeal from his own judgment – see Reid (n 651) at 79.

do not seem to have pressed for such an outcome. This was probably a tactical consideration, as suggesting that *Sharp* was wrong and should be overturned may have been unappealing to the judges as a whole. After all, *Sharp* was a recent, unanimous House of Lords decision, where the bench included three Scottish judges (Lords Clyde, Jauncey and Keith), that provided a solution some considered acceptable. The more promising option was to sever the floating charge from general Scots law, thereby preserving *Sharp* as limited authority while allowing for a different decision to be reached in *Burnett's Tr*. The approach was also an inverted reflection of the appellants' tactics in *Sharp* in the House of Lords, where much of their argument involved carving away property law and focusing upon floating charges. In *Burnett's Tr* Lord Rodger suggested that if *Sharp* could not be distinguished, the House of Lords should not follow it.⁶⁷⁹ But the judges *did* consider it distinguishable: it dealt specifically with relatively new statutory wording introduced into Scots law with floating charges, which allowed for a greater degree of interpretive freedom.⁶⁸⁰

(3) Commentary

After each of its stages, *Sharp* provoked a flurry of commentary.⁶⁸¹ It has been said that the case produced a greater volume of academic debate than any other Scots property law case.⁶⁸² It brought into focus existing debates regarding the meaning of property in Scots law, particularly what rights are acquired by the purchaser of heritable property when the disposition is delivered. *Sharp* can, in part, be seen as a consequence of the low ebb of Scots property law. As DP Sellar notes, it was concerning that there was such great controversy about a concept as simple as the transfer of heritable property.⁶⁸³

Some academics and practitioners, with the support of certain judicial dicta, adopted the “delivery theory”, whereby delivery of the disposition divested the seller of the substance, but not the formal title, of ownership (or they at least considered the matter to be uncertain).⁶⁸⁴

⁶⁷⁹ At para 78.

⁶⁸⁰ See per Lord Rodger at para 84.

⁶⁸¹ For literature on *Sharp* and *Burnett's Tr*, see SLC, *Sharp Report*, Appendix B.

⁶⁸² Gretton and Steven, *PTS*, para 4.22. SLC, *Sharp Report*, para 1.9, states: “Few cases in Scottish legal history have generated so much academic debate as *Sharp*.”

⁶⁸³ DP Sellar, “Commercial Law Update: Securities and Insolvency” (1995) 40 JLSS 311 at 311.

⁶⁸⁴ See eg R Rennie, “Dead on Delivery” 1994 SLT (News) 183; McDonald (n 359); I Doran, “Letter to the Editor” 1995 SLT (News) 101; Outer House stage. AJ McDonald, “*Sharp v Thomson*: What Now?” (1995) 40 JLSS 256; R Rennie, “Keeping the Price and the Property” 1996 JR 68; Inner House stage. And R Rennie, “*Sharp v Thomson*: The Final Act” (1997) 42 JLSS 130; House of Lords stage.

Others, notably Professors Gretton and Reid, advocated a strict division between personal rights and real rights with ownership only transferring upon recording or registration.⁶⁸⁵ Prior to this, the purchaser would have no ownership of the property (substantive or otherwise). The floating charge thus became a proxy for a wider, extant issue in Scots property law, which can be characterised as revolving around the extent to which equitable principles were admitted. The two groups can broadly be termed “functionalists” and “formalists”,⁶⁸⁶ respectively.

It has been suggested by Professor Gretton that in *Sharp* “the problems caused by the floating charge came within an ace of destroying Scottish property law.”⁶⁸⁷ However, although the floating charge via *Sharp* can be considered a conduit for the advance of the delivery theory, there was already a significant divergence of opinion on the property law matters involved.⁶⁸⁸ The problem existed by the time the floating charge was introduced. Only two of the cases referred to by Lords Clyde and Jauncey date from the floating charge era and only one of these relates to floating charges.⁶⁸⁹ These were issues for which obtaining conclusive judicial authority was important for Scots law and the floating charge was an unintended vehicle for this: firstly through *Sharp* and then indirectly through *Burnett’s Tr*, determined in *Sharp’s* shadow.

As was shown at the Outer House and Inner House stages, it was perfectly possible to interpret the law of floating charges in accordance with a non-equitable conception of property law. And problems created by the floating charge, in policy terms or otherwise, such as an absence of publicity for attachment, could be resolved by legislation. Instead, it might reasonably be argued that the problem with *Sharp* was the interpretation given to the floating charge in the House of Lords.

⁶⁸⁵ See eg GL Gretton, “Sharp Cases Make Good Law” 1994 SLT (News) 313; Outer House stage. KGC Reid, “*Sharp v Thomson: A Civilian Perspective*” 1995 SLT (News) 75; Inner House stage. And Reid (n 660); Reid (n 651); House of Lords stage. See also the earlier debates between Reid and I Doran at 1982 SLT (News) 149; 1985 SLT (News) 165 and 280; and the articles by McDonald and Gretton and Reid noted above (n 502); and Reid, *Property*, paras 640ff. And see eg the recommendations by NR Whitty, “*Sharp v Thomson: Identifying the Mischief*” 1995 SLT (News) 79.

⁶⁸⁶ The formalists can also be termed “traditionalists” or “purists”.

⁶⁸⁷ GL Gretton, “The Rational and the National” in EC Reid, D Carey Miller (eds), *A Mixed Legal System in Transition: TB Smith and the Progress of Scots Law* (2005), 41; and see Gretton (n 673).

⁶⁸⁸ See above. There is also some acknowledgment of the existing uncertainty by Gretton (n 677) at 389ff.

⁶⁸⁹ *Telford*.

Much of the commentary after the House of Lords stage considered the consequences of the decision and the extent of the ratio. Many of the criticisms levelled against the speeches by Lords Clyde and Jauncey remain forceful and apt. These include: the inconsistencies between the speeches; the suggestion that “property” is not a technical term; the reliance on controversial cases like *Heritable Reversionary*,⁶⁹⁰ the fact that the necessity of acting in a fraudulent way to defeat the donee would exist from the conclusion of missives; and the apparent application of English law to a Scottish matter (by Lord Jauncey especially), by seeking to expand the notion of beneficial interest.⁶⁹¹ In addition, it has been suggested that Lord Jauncey’s acknowledgement that after delivery of a disposition it would still be possible for a donor to grant valid standard securities conflicts with his recognition of a floating charge as a deemed standard security upon attachment.⁶⁹² However, the statutory hypothesis is the mechanism used to explain the operation of a floating charge *if* attachment takes place. It does not necessarily determine the property to which the floating charge attaches. Nevertheless, the ability to grant a standard security is an important point to demonstrate that the subjects are the grantor’s “property” and therefore should be affected by a charge.⁶⁹³

As Gretton and Reid write, professional opinion was divided as to whether the narrower or wider interpretation was to be favoured – and the law was in flux with the prospect of change through further cases and legislation.⁶⁹⁴ A wide interpretation of the ratio in *Sharp* was criticised heavily by certain academics and there was, apparently, a general favouring of a narrow ratio (amongst judges and academics), especially as the potential implications of the decision were realised.⁶⁹⁵ In Professor Gretton’s view, the narrow ratio of *Sharp* was “unsatisfactory but not disastrous”, unlike the wide ratio.⁶⁹⁶

⁶⁹⁰ The parallels between this case and *Sharp* are interesting. Gloag and Irvine, *Security*, 153, for example, note that *Heritable Reversionary* was decided upon “commercial rather than feudal principles”. See also Gretton (n 673) at 136 who notes parallels between the cases and their aftermaths.

⁶⁹¹ For such criticisms, see eg Reid (n 651) at 80; Reid (n 660) at 466ff.

⁶⁹² See eg Reid (n 660) at 466.

⁶⁹³ This ties in with Lord Sutherland’s view in the Inner House (at 482) that it would be illogical if the subjects could be used for the purpose of creating fixed security but not a floating charge.

⁶⁹⁴ GL Gretton and KGC Reid, *Conveyancing*, 2nd edn (1999), para 11.31. And see also eg GL Gretton, “Equitable Ownership in Scots Law?” (2001) 5 EdinLR 73.

⁶⁹⁵ Gretton (n 673) at 135f. Cf K Swinton, “Is There a Need to Reverse *Sharp v Thomson*?” (2001) 69 SLG 156 at 159, who noted that the House of Lords’ solution was “welcomed by practitioners as a sensible result which [they] would be loathe to lose”. However, he acknowledged (at 156) that *Sharp* did not assist where receivership (or presumably liquidation) pre-dated the price being paid in exchange for the disposition.

⁶⁹⁶ GL Gretton, “Scots Law in Shock: Real Rights and Equitable Interests” (1998) 6 ERPL 403 at 406.

Sharp can be analysed through the lens of exceptionalism and integrationism. After the decision, there was uncertainty as to how exceptional or integrated the floating charge was considered to be as regards Scots law more broadly. These different perspectives corresponded to whether a narrow or wide ratio should, or did, emanate from *Sharp*. For on Lord Clyde's analysis, the floating charge was more clearly treated as exceptional, while Lord Jauncey seems to have considered his judgment to extend beyond floating charges and to involve beneficial interest applying across Scots property law. As Professor Gretton notes, there were elements of the wide and narrow ratio in both speeches, but in Lord Clyde's speech the latter was predominant while in Lord Jauncey's it was the former.⁶⁹⁷ After *Sharp*, many traditionalists must have feared the potential for a wide integrated application, which might have affected other parts of property law.⁶⁹⁸

Due to the controversy surrounding *Sharp*, the Scottish Justice Minister, Jim Wallace, asked the SLC, in September 2000, to consider the case's implications and to make recommendations. The SLC's Discussion Paper⁶⁹⁹ proposed various reforms such as overturning *Sharp* and providing that the floating charge would only attach upon registration of an attachment event. The SLC plans were positive and integrative on two counts: firstly, by treating property within the floating charge context in the same way as for the rest of property law; and, secondly, by introducing a procedure which would allow the floating charge to better cohere with the fundamental publicity principle in Scots law. However, due to *Burnett's Tr*, which determined that the exceptional approach (the narrow ratio) prevailed, the SLC abandoned plans to overturn *Sharp* by legislation. They did still produce a draft Bill containing provisions to introduce the necessity of registration for attachment under the 2007 Act, but these proposals were not taken forward.⁷⁰⁰

Burnett's Tr involved the "alien" floating charge being separated from wider law to help preserve a particular analysis of property law. Professor Reid, shortly after the House of Lords decision in *Sharp*, had suggested that the narrow statutory interpretation ratio represented a

⁶⁹⁷ Ibid.

⁶⁹⁸ See Gretton (n 673) at 136.

⁶⁹⁹ Scottish Law Commission, *Discussion Paper on Sharp v Thomson* (DP 114) (2001).

⁷⁰⁰ See 53ff. The 2007 Act did, however, introduce certain recommended measures such as a trustee in sequestration, and parties obtaining title from them, not being able to complete title within 28 days (s 17(1) inserting s 31(1A) and (1B) into the Bankruptcy (Scotland) Act 1985) – see now 2016 Act, s 78(3) and (4). However, since this is limited to sequestration, it is not directly relevant to floating charges.

“plausible compromise” with property law “preserved” and “justice... done”.⁷⁰¹ And the absence of subsequent changes to re-integrate the floating charge with the rest of Scots law is notable. In this respect, the order in which *Sharp* and *Burnett’s Tr* were decided might have been crucial. If the non-floating charge case was decided between 1994 and 1997, there would have been a real possibility of the purchasers winning. A number of the arguments and authorities used in *Sharp* would have been available and the House of Lords personnel may have been amenable to such a view.⁷⁰² It is, however, likely that remedial legislation would have been introduced if the case was decided in favour of the purchasers, but this may also have allowed for floating charges to be interpreted in line with wider law.⁷⁰³

(4) The Ratio’s Extent

Despite a narrow ratio in *Sharp* ultimately prevailing, the precise extent of this ratio is unclear. What can be said is that property still owned by a selling party will leave that party’s “property and undertaking” upon the occurrence of a certain event (or events) in the transaction.⁷⁰⁴ If the property is no longer within its “property and undertaking” then a floating charge granted by it cannot attach to such property. It is worthwhile emphasising that the floating charge will have *no effect* on the property, it is not simply a ranking question.

As Professor Reid notes, the decision in *Sharp* is “severely functionalist” and this causes friction with property law, which is “severely, and unavoidably, formalistic”.⁷⁰⁵ However, attempts to identify the particular legal or practical steps that render a floating charge unattachable involve the use of form, and even Lords Jauncey and Clyde seem to utilise the particular stages in the transfer of property in this respect. It is therefore necessary to consider

⁷⁰¹ Reid (n 651) at 80.

⁷⁰² It is not unreasonable to believe that Lord Clyde alone would have favoured the trustee. In *Burnett’s Tr* two of the non-Scottish judges (see Lord Hoffmann at paras 2ff; and Lord Hobhouse at paras 52ff) expressed dissatisfaction at the position of Scots law on the matter, but they essentially deferred to Lords Hope and Rodger. See A Paterson, *Final Judgment: The Last Law Lords and the Supreme Court* (2013) 187 and 242 who notes that initially Lords Hobhouse and Hoffmann wished to allow the appeal and Lord Rodger had some of the same doubts.

⁷⁰³ Given the wider implications of a non-floating charge case, there would have been a greater likelihood of subsequent legislation.

⁷⁰⁴ See eg SLC, *Sharp Report*, paras 1.6ff and 2.2ff. The SLC acknowledge and (rightly) reject an alternative view that *Sharp* was impliedly overruled. See also the views of the Inner House in *Burnett’s Tr* 2002 SC 580.

⁷⁰⁵ Reid (n 651) at 83.

the ratio, including the term “property and undertaking” and the accompanying nebulous concept of “beneficial interest”, with that in mind.

(a) The Key Stage(s)

The particular point at which property leaves the “property and undertaking” remains uncertain. For heritable property, a sale transaction usually has three distinct stages: conclusion of contract by way of missives, delivery of the disposition, and recording or registration of the disposition.⁷⁰⁶ These are generally supplemented by other agreed events, such as payment of the price and giving the purchasers entry (possession). However, the only point at which ownership passes is upon registration.⁷⁰⁷ In *Sharp*, the purchasers had paid, been given possession and received the disposition, all before attachment, and, therefore, one or more of these steps is crucial for the application of the ratio. The general view is that delivery of the disposition is the key point;⁷⁰⁸ however, others suggest that payment or the transfer of possession are, respectively, the crucial moments.⁷⁰⁹ If a strict interpretation of *Sharp* is taken, it requires each of these three steps cumulatively. And it might even be necessary for there to be no additional contractual, or other, impediments upon the purchaser completing title, as this was also the position in *Sharp*. A more liberal approach would require only two or even one of these steps to exist. And the most liberal of all would suggest that any of the three steps would trigger the ratio.

It is, however, difficult to justify the *order* of required steps having any significance, so long as they occur before the attachment of the floating charge.⁷¹⁰ Likewise, the steps do not need

⁷⁰⁶ This was recognised in *Sharp*: see eg Lord Jauncey at 70.

⁷⁰⁷ 2012 Act, s 50(2), replaced the Abolition of Feudal Tenure etc (Scotland) Act 2000, s 4, which was to the same effect. Previously, the Land Registration (Scotland) Act 1979, s 3(1)(a), conferred a real right of ownership upon the party registered as owner in the Land Register, which would invariably follow upon the Keeper’s receipt of a valid disposition. Since 1617 recording or registration has been necessary to transfer ownership – see the Registration Act 1617. See also *Young v Leith* (1847) 9 D 932, which was referred to in *Sharp*, see eg per Lord Jauncey at 75 and per Lord Clyde at 80. In *Sharp* the court seems to have overlooked the affirmation of the Inner House decision in *Young* by the House of Lords – *Young v Leith* (1848) 2 Ross LC 103, HL.

⁷⁰⁸ SLC, *Sharp Report*, para 2.4; KGC Reid and GL Gretton, *Land Registration* (2017), para 12.19.

⁷⁰⁹ See eg J MacLeod, “Non-Judicial Real Security” in IG MacNeil (ed), *Scots Commercial Law* (2014), para 11.74, who seems to suggest that payment of the price is the key stage. As noted at SLC, *Sharp Report*, para 2.4, emphasis on the term “undertaking” may most obviously correspond to possession.

⁷¹⁰ Eg why should it matter if the disposition is delivered before possession is entered into (if both elements are required)?

to have been met for a particular period of time, prior to a charge attaching, in order for the charge not to attach to the property being sold.⁷¹¹

(i) Price (Payment Received)

An important point raised in *Sharp* was the apparent unfairness if the floating charge could attach to the property and the purchase money paid to the seller.⁷¹² If this is the fundamental argument in favour of the decision then payment of the price should be the *only* necessary stage for a transferor-granted floating charge to become unattachable to the property (prior to transfer of ownership). The money paid replaces the property to be transferred, within the “property and undertaking” of the transferor. If any other stage is necessary, even in addition to the payment of the price, then it would be possible for a floating charge to attach to the property *and* the money. For example, if delivery of the disposition is also a key stage, then if C Ltd makes payment before receiving the disposition from A Ltd, B Bank’s charge over A Ltd’s property can attach to the money received and the heritable property. Conversely, if A Ltd delivered the disposition before receiving payment from C Ltd, then D Bank’s charge over C Ltd’s property might be able to attach to the money and the heritable property.⁷¹³ A Ltd would, of course, have a personal right to receive the price (which could be attached by B Bank’s charge), but this may have little value if C Ltd is insolvent.

There is, however, uncertainty as to what constitutes the price and when it is considered paid.⁷¹⁴ If payment is to be made in instalments, does the full amount need to be paid for the transferor-granted charge to become unattachable? Indeed, in *Sharp*, there were two separate payments.⁷¹⁵ Whether it is the full price or a lesser amount, there is scope for unfairness. And, extending the issue of “fairness” more widely, why should a paying purchaser receive special protection when there may be other creditors who have rendered services but remain unpaid by the seller company?⁷¹⁶

⁷¹¹ In *Sharp* no emphasis was placed upon, for example, how long ago the disposition was delivered.

⁷¹² See eg Lord Jauncey at 70 and Lord Clyde at 82.

⁷¹³ This may depend on registration of the disposition, unless a full equitable attachment approach is adopted.

⁷¹⁴ See eg Reid (n 651) at 82.

⁷¹⁵ See per Lord Clyde at 78.

⁷¹⁶ Eg Whitty (n 685) at 80.

(ii) *Disposition*

As regards the potential key stages, Lords Clyde and Jauncey focused most obviously on delivery of the disposition. They seemed to consider it an important point in stopping a floating charge attaching to property and the price. This is understandable given that the delivery is a recognised stage in the sale of heritable property and the disposition is usually delivered in exchange for the price. The (almost) simultaneity between the two, as well as judicial dicta apparently identifying property consequences of delivery, meant the judges could use delivery of the disposition as a point from which the floating charge would not attach to heritable property *and* the money received. To do this, they seem to have interpreted delivery of the disposition as causing “beneficial interest” to pass to the purchaser, and thus the property left the “property and undertaking” of the seller.⁷¹⁷ Certainly, this reflects the special significance of delivery of a disposition in the transfer of ownership of land. The disposition must be delivered for ownership to be obtained by a purchaser or other acquirer. The same is not true for possession or payment of the price, which, unlike delivery of the disposition, can also occur in different ways. (For example, possession might be civil rather than natural and the price might be payable in instalments, or deferred or made in a form other than money.)

From the moment that a valid disposition is delivered, the disponee has the power to obtain ownership without the disponent’s participation. Therefore, if a disposition is delivered, it is an objective indicator that the seller is willing to transfer ownership.⁷¹⁸ The seller will, or should, only deliver the disposition if it is content to lose ownership of the property, and will therefore usually want payment in return at this point. A purchaser, meanwhile, should only pay when receiving the disposition. As has been argued by others, the circumstances of *Sharp*, involving the delayed delivery of a disposition after payment had been made, would enable purchasers to successfully sue their solicitors.⁷¹⁹

There could also be situations in which the disposition is delivered before or after the price is paid. And this could allow for attachment to the money paid and the heritable property. Thus, although in the circumstances of *Sharp* a fairer solution for the purchaser was obtained, if the disposition had been delivered only a few days later, then the charge seemingly *would* have

⁷¹⁷ See Lord Jauncey at 70ff and Lord Clyde at 80ff.

⁷¹⁸ It can be seen as an expression of will to transfer ownership without further conditions. If it was up to the parties alone, it would probably be this point that they would want ownership to transfer.

⁷¹⁹ See eg Reid (n 660) at 468.

attached to the property *and* the price paid. The protection of the purchaser arising from the decision therefore only has limited application. And it is easy to overstate its value in this regard.

As discussed in the previous chapter, the same outcome in *Sharp*, favouring the purchaser against the receiver, could have been reached by separating attachment of the charge from its enforcement. There are similarities between the “separation” approach and recognising delivery of the disposition as the key stage for non-attachability of a charge: the former would also require pre-attachment delivery by the chargor. However, the separation approach is more closely connected to the question of ownership; not only is the delivery of the disposition necessary, but its recording or registration must precede the receiver successfully realising the property by transferring it to another. Only once ownership transfers to the purchaser would the charge become unenforceable. An attraction of the separation approach is that it integrates the floating charge into the rest of Scots property and insolvency law and avoids much of the complexity and uncertainty involved in a *Sharp*-type solution.⁷²⁰

(iii) Possession

Possession of the property is afforded no express significance within the opinions in *Sharp*.⁷²¹ The giving of possession and delivery of the disposition will usually be almost simultaneous, which might provide a false impression of the importance of possession in the floating charge context. In *Sharp*, however, the purchaser’s possession preceded delivery by a considerable period. Would B Bank’s floating charge really fail to attach simply because A Ltd lets C Ltd occupy the property, prior to delivery of a disposition and the payment of the price? This seems unlikely. And, conversely, it is probably not the case that B Bank’s floating charge would attach simply because A Ltd still has possession,⁷²² if A Ltd has delivered a disposition to C Ltd and C Ltd has paid the price to A Ltd. The only way in which possession could have

⁷²⁰ For greater conformity with *Sharp*, it could even be said that, where property has been transferred and become unenforceable by the floating charge, it is no longer attached.

⁷²¹ Indeed, in *Gibson*, which was relied on in *Sharp* (at 70, 74 and 84), the buyers were in possession of the property and had also paid the price, but LP Emslie (at 27) rejected the significance of these and seemed to place emphasis on the delivery of the disposition. This is also supported by the use in *Sharp* (at 73 and 80) of *Thomas v Lord Advocate* 1953 SC 151, an estate duty case, where delivery of a disposition, rather than later occupation of the property, provided the key date.

⁷²² Eg if the giving of entry was delayed for some reason.

significance is if attachment depends on property remaining a business asset and possession or use is a factor in this regard.⁷²³

(b) Beyond Receivership?

Sharp is probably a decision about the law of floating charges, not just attachment of a charge in receivership;⁷²⁴ although the case focused upon interpreting receivership statutory provisions, there are substantively equivalent attachment provisions for liquidation and administration and the creation provisions apply to all floating charges.⁷²⁵ Yet, even though the charge will seemingly not attach in a liquidation or administration where the facts are equivalent to those in *Sharp*, applying *Burnett's Tr* analogically means it is highly unlikely the *Sharp* ratio extends to determining the property available in those processes more generally, for non-floating charge creditors.⁷²⁶ (There may, however, be slight doubt here due to the use of references to the company's "property" in the relevant corporate insolvency legislation.)⁷²⁷

It appears possible then for property to be part of a chargor's "property" subject to liquidation or administration but outside its "property and undertaking". This may arise if delivery of the disposition is the key stage for non-attachment, and such delivery has taken place. As long as the donee has not registered the disposition (whether through tardiness, the disposition having been lost, or otherwise), the property will be available to the liquidator or administrator. These latter parties can therefore realise the property by selling it to others and receiving the

⁷²³ See below.

⁷²⁴ See also S Wortley, "Sharp Practice for Trusting Conveyancers" (1997) 65 SLG 113 at 115, who notes that it is a case about "the law of floating charges, not insolvency".

⁷²⁵ See eg 75ff.

⁷²⁶ For discussion before *Burnett's Tr*, see eg Reid (n 651) at 82f. Cf JG Birrell, "*Sharp v Thomson: The Impact on Banking and Insolvency Law*" 1997 SLT (News) 151 at 154, who considered that eg the language of 1986 Act, s 145, might mean a liquidator could not obtain vesting of the company's property if the company only had "bare title". He also suggested (at 154f), that an administration order would not extend to sold heritable (or incorporeal moveable) property for which a disposition (or assignation) had been granted but was unrecorded (or unintimated).

⁷²⁷ In *Burnett's Tr*, Lord Rodger, at para 84, stated that the term "whole estate" being interpreted in that case was "rather different" from "property and undertaking". But it may be "undertaking" that creates this difference. As H Goudy, "Contingent Right in Bankruptcy" 1893 JR 212 at 214f, notes, under the Bankruptcy (Scotland) Act 1856, s 4, "estate" and "property" were expressed to have the same meaning which included "every kind of Property, Heritable or Moveable, wherever situated, and all Rights, Powers, and Interests therein capable of legal Alienation, or of being affected by Diligence or attached for Debt." Such equivalence may be implied for the modern meaning of a person's "estate" in the personal bankruptcy legislation and the company's "property" in the corporate insolvency legislation.

proceeds. (A quick sale may be particularly likely in the context of pre-pack administrations.) Since a charge will apparently not attach to the sold property, it will also not attach to the money received by a liquidator or administrator in return for that property.⁷²⁸

Alternatively, a liquidator may obtain title and the Keeper would then be expected to refuse an attempted registration by the disponee.⁷²⁹ Lord Jauncey seems to have overlooked the potential “race to the register” between a disponee and a trustee in sequestration or liquidator, and assumed that a disponee would automatically prevail.⁷³⁰ By contrast, Lord Clyde recognised the existence of such a race but noted it did not apply to receivers and therefore used this to support a narrow conception of attachment (in receivership).⁷³¹ Like a receiver, an administrator can seemingly not acquire title but can attempt to transfer to another party before the disponee registers.

If the property did fall to be dealt with in A Ltd’s liquidation, C Ltd would only rank as an unsecured creditor. And B Bank might reasonably query why its security was ineffective over the property in the liquidation, while lower-ranking secured creditors, and even unsecured creditors,⁷³² would stand to benefit.⁷³³ Certainly, the automatic inequity arising from a direct competition between a chargeholder and a purchaser would be significantly diminished, as the purchaser would not get the property and would only be an unsecured creditor. The competition in *Sharp* was solely between a receiver, acting in the interests of a chargeholder, and purchasers (and the building society to whom they had granted a standard security). By contrast, liquidators and administrators act in the interests of all creditors. And it is notable that in *Sharp* one important issue raised was the relative lack of public notice for receivership, but there is somewhat more publicity for administration and liquidation.⁷³⁴ However, given that property is apparently no longer in the “property and undertaking” of a company when a disposition is delivered, how would a charge attach if liquidation or administration arises?

⁷²⁸ See 57ff.

⁷²⁹ 2012 Act, s 21(2) and (3), s 23(1)(b) and s 26(1)(a).

⁷³⁰ At 77. And see eg Reid (n 660) at 466.

⁷³¹ At 83.

⁷³² In *Sharp* it would have been possible for a lower-ranking standard security to prevail over the floating charge as the former would continue to encumber the property after the property left the “property and undertaking” of the seller.

⁷³³ DP Sellar, “Commercial Law Update: Rights in Security and Insolvencies” (1997) 42 JLSS 181 at 181, queries why the purchasers of property would not also prevail in a liquidation and, if they did not, why unsecured creditors would have priority over the chargeholder. See also Wortley (n 724) at 114f.

⁷³⁴ See 53ff.

Does the property return to the property and undertaking at some point? And, if so, when and how? This would also cause difficulties for a liquidator or administrator dealing with a company's property, as he would not know whether he had to factor in distribution to chargeholders. The courts might even disallow the chargeholder's claim on the policy basis that it would diminish the amount which a purchaser could expect to receive as an unsecured creditor.

The policy motivation in *Sharp* is notable and may reflect an effort to challenge the powerful position of the chargeholder.⁷³⁵ The power of the chargeholder, and the negative impact of this on unsecured creditors, became more unsatisfactory from the 1990s onwards.⁷³⁶ The 2002 Act introduced the prescribed part, which provides unsecured creditors with a proportion of charged proceeds.⁷³⁷ But this will not be paid if the charge does not attach, and these unsecured creditors will therefore lose out if there are prior-ranking creditors who would have ranked behind the charge had it attached.

The emphasis on statutory interpretation in *Sharp* and the desirability of consistency across the law of floating charges and enforcement methods suggests that the *Sharp* ratio does apply to the attachment of charges in liquidation and administration.⁷³⁸ But the fact that property could be available to a liquidator or administrator, and thus distributable to parties ranking below a chargeholder, but not to the chargeholder itself, is an odd result. This is especially so given that they are parties through whom a charge is enforceable. It is another demonstration of why an approach: (i) tying attachment to the company's property available in a liquidation (or equivalent); and (ii) separating attachment and enforcement; would be preferable. Instead, the current law provides inconsistency as regards insolvency law, the rights of parties competing with a chargeholder, and the charge's attachment.

⁷³⁵ This is a point made by Wortley (n 724) at 115.

⁷³⁶ Until the early 1990s chargeholders seem to have had more success in litigation (largely due to the successful actions of receivers): see eg *Telford*; *Lord Advocate v RBS*; *Cumbernauld Development Corporation v Mustone Ltd* 1983 SLT (Sh Ct) 55; *Forth & Clyde*; and *Ross* (n 177). Cf *Iona Hotels*; *Scottish & Newcastle Breweries Plc v Ascot Inns Ltd (In Receivership)* 1994 SLT 1140; *Grampian RC v Drill Stem (Inspection Services) Ltd (In Receivership)* 1994 SCLR 36, Sh Ct; *Sharp*; and now *MacMillan*.

⁷³⁷ The power of chargeholders has also been diminished by the general replacement of administrative receivership by administration.

⁷³⁸ Cf *Greene and Fletcher: Receivership*, para 2.40.

(c) Beyond Heritable Property?

Another uncertain issue is whether the *Sharp* ratio is limited to heritable property, or is also applicable to corporeal moveables and/or incorporeal property. One point in favour of the former view is that Lord Clyde seemed to perceive that the judgment would involve no implications for moveable property.⁷³⁹ Also, Lord Clyde and Lord Jauncey's focus on heritable property and the delivery of a disposition, a deed not used for moveable property, suggests a limited view of the ratio.

Yet, as some commentators have suggested, there is an almost irresistible analogy between the stages for the transfer of heritable property and incorporeal property.⁷⁴⁰ Sellar rightfully suggests that the failure to give proper consideration to incorporeal property in *Sharp* is symptomatic of Scots law's "neglect" of that type of property.⁷⁴¹ The wider problems involving *Sharp*, as well as the heritable property focus of the judgments mean that the application of the ratio to incorporeal property should be resisted.

In the Inner House in *Sharp* Lord President Hope identified a number of difficulties relating to corporeal moveables that might arise if property attached was given a meaning at odds with wider property law.⁷⁴² These remain valid points; however, given the different processes for the transfer of corporeal moveable property, the ratio from the House of Lords decision either does not apply, or has little practical effect in that context.⁷⁴³ Of course, in the unlikely event that possession is the key stage then clearly *Sharp* is likely to have more application to corporeal moveable property than incorporeal property.

⁷³⁹ At 85.

⁷⁴⁰ See eg D Guild, "*Sharp v Thomson: A Practitioner's View*" (1997) 42 JLSS 274 at 275; *Palmer's Company Law* (n 191), para 13.208.1. See also SLC, *Sharp Report*, para 2.6, where they suggest that the ratio presumably applies to other types of property and refer expressly to assignation of book debts. For further discussion of *Sharp* and incorporeal property, see 238f and 264.

⁷⁴¹ Sellar (n 733) at 181. This is true within the wider context of floating charges: see chapter 9.

⁷⁴² 1995 SC 455 at 477f.

⁷⁴³ See 212ff.

(d) Beyond Sale?

Similarly, it is not clear whether the ratio of *Sharp* extends to transactions beyond ordinary sale.⁷⁴⁴ Although applying *Sharp* as narrowly as possible is desirable, it is not obvious why it cannot apply to transactions such as exchange (excambion). And a gratuitous transfer surely also involves the seller losing “beneficial interest” in the property, so would policy reasons alone justify a seller-granted charge attaching if a disposition had been delivered? Even if *Sharp* only applies to sales, would this include sale for security purposes? The transfer of ownership as security is no longer possible for heritable property, but was historically, and it remains relevant for other types of property interacting with the floating charge. There are no obvious answers to these questions.

(e) Beyond Transfer of Ownership?

Sharp involved transfer of ownership. However, could the case’s ratio also apply to the creation of other types of real right? For example, a floating charge attaches between the chargor delivering a standard security deed and the registration of that deed in the Land Register.⁷⁴⁵ The prevailing view is that the ratio does not extend beyond the transfer of ownership.⁷⁴⁶ That is justifiable on the basis that transfer involves property leaving the chargor’s patrimony, whereas when other real rights are created, property remains in the chargor’s patrimony, albeit encumbered by those other rights. Unlike property being transferred, it is not tenable to suggest that property intended to remain in the chargor’s patrimony is no longer in its “property and undertaking”. A competition between the charge and subordinate real rights depends upon the floating charge attaching to property and the legislation provides details of ranking relationships between the floating charge and real security rights, including standard securities.⁷⁴⁷

Even in the context of beneficial interest it is hard to argue that such an interest transfers when a subordinate real right is created. The granting company has decided to retain ownership of

⁷⁴⁴ However, see SLC, *Sharp Report*, para 2.5.

⁷⁴⁵ See *Halliday’s Conveyancing*, vol 2, para 57-42.

⁷⁴⁶ SLC, *Sharp Report*, para 2.5.

⁷⁴⁷ See 1985 Act, s 464, and the definition of fixed security which includes a reference to standard security (s 486(1)).

the property, which means it has continued value for them, as the property can still be used physically or utilised to raise finance, through sale or otherwise.⁷⁴⁸

(5) “Property and Undertaking”

The *Sharp* ratio is dependent upon the interpretation of the statutory wording: “property...comprised in [the company’s] property and undertaking”. Lord Clyde suggested that “property” is contextual and “not a technical term of Scots law”.⁷⁴⁹ He also indicated that it may not be “coextensive” with real right or feudal title. To suggest that “property” has no core legal meaning corresponding to property law seems illogical.⁷⁵⁰ This is more apparent twenty years later where feudal title has been fully replaced by the real right of ownership, which is, of course, firmly entrenched within a common legal understanding of “property”.⁷⁵¹

Lord Clyde also drew upon Lord Watson’s attempt to define “property” in *Heritable Reversionary*.⁷⁵² He noted that the editor of the fourth edition of Goudy’s *Bankruptcy*, TA Fyfe, suggested Lord Watson’s definition seemed to “exclude the property sold by the bankrupt upon a delivered conveyance which has remained unrecorded”.⁷⁵³ Beyond this, Lord Clyde placed particular emphasis on the combination of “undertaking” with “property”, in the floating charges legislation. He considered that this:

seems to... take one away from any exclusive concentration on the word property, to look to the variations in the identity of the property which may occur during the continuing course of the company’s business, and to invite a less strict construction which may take account not only of title but of beneficial interest.⁷⁵⁴

⁷⁴⁸ And see *Birrell* (n 726) at 153, who, on the basis of Lord Jauncey’s comments, considers that the standard security grantor’s “right of redemption” distinguishes that case from the delivery of a disposition.

⁷⁴⁹ At 80.

⁷⁵⁰ See eg comments of Reid (n 651) at 80.

⁷⁵¹ 2012 Act, s 50(2) (see n 707). And s 50(3) states: “An unregistered disposition does not transfer ownership.”

⁷⁵² *Sharp* per Lord Clyde at 81; and see also Lord Jauncey at 71f. *Heritable Reversionary* per Lord Watson at 49f.

⁷⁵³ H Goudy, *A Treatise on the Law of Bankruptcy in Scotland*, 4th edn by TA Fyfe (1914), 251 n(c). (But he notes that such property can be adjudged by the seller’s creditors.) Cf the 2nd edn (1895), Goudy’s last edition, where the equivalent footnote (265, n(c)) contains no mention of this, despite Goudy having appeared as counsel in *Heritable Reversionary*.

⁷⁵⁴ At 82.

This passage is notable in a number of respects. Firstly, it accentuates the effect of the term “undertaking”. If the use of “undertaking” means that “beneficial interest” is a requirement for attachment, that is preferable to the word “property” alone having such effect. The approach protects general property law from functionalism and gives less credence to reading beneficial interest into other legislation that refers to a party’s “property”. Lord Jauncey places less emphasis on “undertaking”, and therefore his judgment remains the more dangerous for general Scots property law.⁷⁵⁵

Secondly, the reference to “undertaking” involving changes in the company’s property corresponds to a well-recognised meaning of the term when it was used in the original floating charges legislation.⁷⁵⁶ Yet Lord Clyde is surely mistaken to consider that “undertaking” allows for the utilisation of beneficial interest when examining the relationship between the floating charge and property. It is as if, without the floating charge, beneficial interest is not perceptible in property law, except within the narrow confines of trusts, but when the lens of the floating charge is used, suddenly, beneficial interest becomes visible to determine what property a charge attaches to. Lord Clyde may have conflated English-derived terminology, and the transplanting of a security based on the English model, with wider equitable concepts that were never intended to be introduced. It seems far-fetched to assert that “property and undertaking” imported a system akin to English equity.⁷⁵⁷

Thirdly, the final part of Lord Clyde’s dictum above suggests he favoured a limited ownership attachment approach: ownership being necessary for attachment but with a further element, beneficial interest, also required.⁷⁵⁸ (These two elements might correspond to “property” and “undertaking” respectively.) This approach is apparent too from Lord Clyde’s following comment: “Even if the subjects must be in the legal ownership of the company for the charge to attach, it does not follow that everything over which it has a real right falls within its property and undertaking.”⁷⁵⁹

⁷⁵⁵ Lord Clyde also seems to give greater credence to the notion of the exceptionalism of the floating charge.

⁷⁵⁶ See chapter 4.

⁷⁵⁷ Fitting the floating charge into wider Scots law was particularly sensible since the floating charge was an innovation, and a common law version of it had been rejected.

⁷⁵⁸ Again, see 93ff above. This contrasts with the Outer House and Inner House where the judges all favoured a full ownership analysis.

⁷⁵⁹ At 82. But see eg at 80 where his comments could be construed as supporting a full equitable attachment approach.

Lord Jauncey’s analysis of statutory provisions in *Sharp* was largely focused upon s 53(7) of the 1986 Act, which provides that:

On the appointment of a receiver under this section, the floating charge by virtue of which he was appointed attaches to the property then subject to the charge; and such attachment has effect as if the charge was a fixed security over the property to which it has attached.

The reference to “then subject to the charge” limits “property”⁷⁶⁰ to such property that, at the relevant time, was in the company’s property and undertaking and was charged by the floating charge instrument. Lord Jauncey considered that the reference to “property and undertaking” requires to “be given the practical meaning of property which is available for the use of the company, in which it has a beneficial interest, and which it is in law entitled to dispense or subject to heritable security”.⁷⁶¹ It is unclear from Lord Jauncey’s words whether company use is a separate part of the attachment test from: (i) beneficial interest; and (ii) entitlement to deal with the property; or whether it is comprised of (i) and (ii). And it is not even certain if (i) and (ii) are (entirely) separate. By “entitled” Lord Jauncey means what a party is *allowed* to do rather than what that party has the *power* to do. A party is not “allowed” to undertake juridical acts that are contractually prohibited, such as transferring ownership to another party in breach of a pre-existing obligation. But if this were sufficient for property to leave the “property and undertaking” of the company, it would occur from the conclusion of contract to transfer ownership. This cannot be right; Lord Jauncey himself noted the absence of property consequences arising from completion of missives, and stressed the importance of delivery of the disposition.⁷⁶²

Nevertheless, the entitlement “in law” to dispense or create heritable securities is (usually) predicated on a party having ownership of the property in question. If this is what is meant, then this indicates a limited ownership attachment approach. However, other dicta suggest Lord Jauncey actually preferred a full equitable attachment approach, focused around

⁷⁶⁰ As per 1985 Act, s 462(1). See Lord Sutherland (at 482) in the Inner House who looked at “property” and “property and undertaking” separately and considered that it was reasonable to suggest that the former meant “anything which could be annexed for the purposes of security.”

⁷⁶¹ At 77. It is not clear from Lord Jauncey’s sentence noted above whether beneficial interest is commensurate with property being available for the company’s use.

⁷⁶² Lord Jauncey at 70 states that at stage 1 (conclusion of missives) “the seller of heritage is divested of no part of his right of property in the subjects”. And cites *Gibson* (n 610) per LP Emslie at 27, in support. The offside goals rule, however, creates potential property consequences from the point of contract. And inhibition, which affects future voluntary acts, does not affect a transaction where the missives have already been concluded – see Gretton, *Inhibition*, 98.

beneficial interest and related features and without direct reference to ownership.⁷⁶³ This interpretation is far removed from ordinary Scots property law. If a floating charge could attach to more than a company owns, as this approach suggests, then there would be difficulties establishing how a liquidator, administrator or receiver would obtain control over such property, given that it would be within the patrimony of another party and therefore subject to that party's insolvency. For example, if beneficial interest had passed to C Ltd but ownership remained with A Ltd, and B Bank and D Bank's charges attached, would property really be available to D Bank? And how would it be so available when the floating charge is enforced by a liquidator or equivalent acting as agent of C Ltd? There are substantial problems for floating charges when patrimonial boundaries are blurred.

Lord Jauncey's reference above to the company being able to use the property, in order for a charge to attach, is also of potential significance.⁷⁶⁴ During the *Sharp* litigation, commentators similarly speculated on a possible practical business-oriented meaning of "property and undertaking". Professor Gretton (and Wortley) posited that, to be attachable, a thing might have to be both in the company's "property" and in its "undertaking", and the latter could require an asset to be something the company pursues its business with.⁷⁶⁵ A business-oriented approach has also been suggested by others. Bennett and Roxburgh proposed an approach connected to accounting practice and commercial reality.⁷⁶⁶ There are considerable factual and legal issues if this is the law, as was recognised by Lord Hope in the Inner House.⁷⁶⁷ In any given case, how could a party know whether or not an item was a business asset? Heritable property can be used physically (by possession) or in a financial sense, by being leased or sold, or used as collateral in financing. There are a multitude of ways in which property could be a business asset, including in ways that breach other obligations. Professor Rennie suggested that where a disposition was delivered in exchange for the price, the property could be considered to have left a company's undertaking by being disposed of in the ordinary course of business.⁷⁶⁸ Despite Rennie believing that the court's views did not align with this analysis,

⁷⁶³ See eg at 74 and 77. And see n 367 above for exceptions as to when a non-owner can grant heritable securities.

⁷⁶⁴ See also Lord Clyde at 82.

⁷⁶⁵ Gretton (n 685) at 314. This view is also adopted by AJM Steven and S Wortley, "The Perils of a Trusting Disposition" 1996 SLT (News) 365 at 368, who state that trust property is not part of a company's business assets.

⁷⁶⁶ DA Bennett and R Roxburgh, "Heritable Property Conveyed by a Company" (1994) 39 JLSS 356 at 356.

⁷⁶⁷ At 478.

⁷⁶⁸ Rennie (1996) (n 684) at 70f.

the proposed relationship between disposal in a business sense and the delivery of a disposition could be closer to the views of Lords Jauncey and Clyde: their apparent identification of delivery of the disposition as a key stage for non-attachability may reflect a realisation of the need for an objectively ascertainable point creating legal consequences. This was perhaps most clearly highlighted by Lord Clyde when stating that where a company has:

sold a heritable subject and delivered a disposition of it to the purchaser so that the company only retains the bare title, has no right and obligation to do anything more as regards the subjects beyond the negative obligation of refraining from conveying them to anyone else, and indeed no longer has the right of lawful disposal, I do not consider it correct to regard the subjects as part of the company's property and undertaking.⁷⁶⁹

(6) Beneficial Interest

Even if Lord Jauncey's "attempt" to introduce an English-style concept of "beneficial interest" into wider Scots law has failed,⁷⁷⁰ such interest appears to be a component of the ratio from *Sharp* and is therefore part of the law of floating charges. Yet it is a term which, until *Sharp*, was largely confined in Scots private law to trusts. The court in *Sharp* expressly rejected the notion that a constructive trust had been established in favour of the purchasers, and consequently this cannot be used as a simple solution to explain the ratio.⁷⁷¹ Given that the existence of beneficial interest in wider Scots law was subsequently dismissed, it may be questioned whether its status in the floating charges context is tenable.⁷⁷² The following discussion proceeds with that major caveat in the background.

Beneficial interest is a feature of English equity.⁷⁷³ Where parties intend to create a proprietary interest immediately, without further actions being required, this can cause beneficial interest to pass.⁷⁷⁴ A purchaser of land can obtain an equitable proprietary interest when the contract is concluded. Once this takes place, the seller "becomes in equity a trustee for the purchaser

⁷⁶⁹ At 82.

⁷⁷⁰ Gretton (2004) (n 677).

⁷⁷¹ Lord Clyde at 85. Cf Lord Hobhouse of Woodborough in *Burnett's Tr* at para 64, who seems to have interpreted the speeches of Jauncey and Clyde in *Sharp* to mean that a trust was created upon the delivery of the disposition.

⁷⁷² Particularly due to the reliance on wider property law authorities in *Sharp*.

⁷⁷³ For discussion of why beneficial interest passes, see R Calnan, *Proprietary Rights and Insolvency* (2010), para 5.54ff.

⁷⁷⁴ See eg *Holroyd v Marshall* (1862) 10 HLC 191; *Tailby v Official Receiver* (1888) 13 App Cas 523; Calnan, *Proprietary Rights* (n 773), para 5.60f.

of the estate sold, and the beneficial ownership passes to the purchaser...⁷⁷⁵ Lords Clyde and Jauncey did not accept that a trust was created in *Sharp*, and, despite placing some importance on a transferor being able to grant deeds without committing fraud as an indicator of beneficial interest,⁷⁷⁶ they did not consider conclusion of contract to be the determinative point for the passing of beneficial interest. Thus, their Lordships adopted equitable notions, but fused with authorities supporting the importance of delivery of the disposition.

Although acknowledging that the holder of an unrecorded disposition only has a personal right, Lord Clyde stated that “he has personally acquired such rights as make it reasonable to use the language of ownership in relation to him...”⁷⁷⁷ He suggested that this had been acknowledged in various cases from *Earl of Fife v Duff*⁷⁷⁸ to *Gibson*.⁷⁷⁹ Lord Jauncey referred to Professor Halliday’s view that between the parties the delivery of a disposition “transfers a right of ownership to the grantee”,⁷⁸⁰ interpreting this to mean that between the buyer and seller the latter has lost “any beneficial rights in the property”.⁷⁸¹ Lord Jauncey noted that a party that has delivered a disposition, in return for the price, has “effectively disposed of [beneficial interest]”.⁷⁸² He also relied on the obiter comments of Lord President Emslie in *Gibson* that a seller “is not, in a question with the purchaser, divested of any part of his right of property in the subjects of sale until... he delivers to the purchaser the appropriate disposition.”⁷⁸³ Lord President Emslie had added that until this moment the buyer’s right is limited under the missives to demanding performance of the seller’s obligation to convey, even if the buyer has paid the price and obtained occupation. The fact that Lord Jauncey referred to this approvingly supports the view that price and possession were not the crucial factors in his judgment; the seller has (at least) the obligation of delivering the disposition incumbent upon them until that delivery takes place. Using this case and others, Lord Jauncey

⁷⁷⁵ *Lysaght v Edwards* (1876) 2 Ch D 499 per Jessel MR at 506. As noted by Calnan, *Proprietary Rights* (n 773), para 5.69, this applies even if the full price is not paid when the contract is concluded. The purchaser’s equitable interest in the meantime secures the portion of the price already paid. This indicates non-unitary elements of such interest under English law.

⁷⁷⁶ In Scots law the relevant stage for this would be conclusion of contract.

⁷⁷⁷ At 83f.

⁷⁷⁸ (1862) 24 D 936.

⁷⁷⁹ N 610.

⁷⁸⁰ *Halliday’s Conveyancing*, vol 1, para 1-13.

⁷⁸¹ At 71.

⁷⁸² At 72.

⁷⁸³ N 610 at 27. Referred to by Lord Jauncey at 74.

considered that heritable property attached by a floating charge is the beneficial interest in such property rather than “bare title”.⁷⁸⁴

Nevertheless, even if the floating charge is exceptional in Scots law, beneficial interest falls within ownership’s field of gravity. Beneficial interest moves from the seller to the buyer and, like ownership, may be a unitary concept, but this is not certain.⁷⁸⁵ In a sale, beneficial interest passes as the buyer is moving towards acquiring ownership and the seller is proceeding towards losing ownership. But the law gives effect to the intended function of the transaction at a prior point and provides that an effect akin to the loss of the seller’s ownership takes place, for floating charge purposes. From the speeches in *Sharp*, what seems to cause beneficial interest to pass is that the parties have reached a stage where the seller has no additional positive obligations to facilitate the transfer of the property. That is why the delivery of the disposition is crucial. Until then, the seller will always have at least one further positive obligation. It indicates that the seller is willing to (or must) allow the purchaser to obtain ownership, and from this point the purchaser has the power to do so unilaterally. In emphasising delivery of the disposition as the key stage, Lords Clyde and Jauncey arguably gave proprietary substance to the concept of *ius ad rem*, as regards the attachability of a floating charge.⁷⁸⁶

It is unclear, however, whether beneficial interest would pass if there were additional personal obligations upon either party, relating to the purchaser’s acquisition of ownership, after the delivery of the disposition.⁷⁸⁷ On the one hand, the purchaser can use its power to register, despite the obligations (although this would amount to breach of contract) and, therefore, perhaps the seller can objectively be considered to have relinquished its “beneficial interest” in the property at this point. Delivery of the disposition is the last *necessary* step for a seller in *every* heritable sale transaction. It is therefore useful to give form to the transfer point of

⁷⁸⁴ At 74. See also his reference (at 75f) to *Hutchison, Main & Co* (n 610) per Lord Shaw of Dunfermline at 15, who contrasted “apparent title” with “beneficial and real title”.

⁷⁸⁵ If it is not unitary and beneficial interest is the only necessary condition for attachment then floating charges granted by the seller and the buyer (eg those of B Bank and D Bank) could both attach. And see Reid (n 651) at 82.

⁷⁸⁶ They may have considered that a *ius ad rem* differs in this context from a *ius crediti* and is obtained when the purchaser has the power to obtain ownership. On the potential difference, see *Edmond v Gordon* (1857) 3 Macq 116 per Lord Cranworth at 122ff, cited by Lord Hope at 463f in the Inner House. And see per Lord Wensleydale at 129f. Also cf the proprietary view in *Sharp* with *Bell’s Dictionary*, entries for “Jus in re-Jus ad rem” (at 621) and “Personal rights” (at 800).

⁷⁸⁷ Eg if it was agreed that a further payment was to be made by purchasers before they could present the disposition for registration. See also Guild (n 740) at 275; Reid (n 651) at 82; Birrell (n 726) at 153.

beneficial interest from seller to purchaser. On the other hand, the fact that conditions were imposed would indicate an intention that no interest should transfer until their fulfilment, and the seller's ability to use its personal rights to stop the purchaser from obtaining ownership could be important. On this view, even if the purchaser did use its power to obtain ownership, despite the conditions, the seller would retain a beneficial interest. But this would still not enable attachment by eg B Bank's floating charge unless a full equitable attachment approach is correct: as the property will otherwise have (at least temporarily) left A Ltd's property and undertaking, on account of the loss of ownership. As a result, D Bank's charge will also not be able to attach, as C Ltd will only have ownership and not beneficial interest.⁷⁸⁸

Another relevant scenario would be where, for example, ownership is transferred from A Ltd to C Ltd but C Ltd is required, upon the fulfilment of conditions, to retransfer the property to A Ltd. It might be that beneficial interest either: (i) does not transfer, due to the qualifications existent from the outset; or (ii) does pass, and can only revert to A Ltd upon the fulfilment of the conditions. The re-transfer of beneficial interest under (ii) may also depend on A Ltd having an unimpeded route to acquiring title again, ie once it receives a disposition from C Ltd. A situation in which the application of (i) may be more apparent is if C Ltd had a recorded *ex facie* absolute disposition, qualified by back letter, and thus held title only in security or trust. In Lord Jauncey's view, relying on *Heritable Reversionary*, C Ltd would never have had any beneficial interest in the subjects.⁷⁸⁹ This would presumably have remained with the disponent. If the full equitable attachment approach is adopted, as indicated by Lord Jauncey's opinion, and beneficial interest is the only determinant as to whether or not a floating charge attaches, then it is possible for property disposed *ex facie* absolutely to be attached by B Bank's floating charge. However, if ownership is a necessary condition for attachment then this will not be possible. Lord Jauncey's views on *ex facie* absolute dispositions correspond to a wider functionalist approach to these securities, which, as will be noted below, has not prevailed.

Therefore, like so much else regarding *Sharp*, ascertaining the meaning and implications of "beneficial interest" is supremely difficult. As already discussed, *Sharp* is problematic for a variety of reasons: its disharmony with property law and insolvency law, contexts within which floating charges operate; the uncertainty regarding the content and extent of the ratio;

⁷⁸⁸ But would be able to attach under a full ownership attachment approach.

⁷⁸⁹ At 72.

the conceptual problem of identifying beneficial interest in a system which functions on the basis of a personal/real right dichotomy; and because the property and undertaking terminology was never intended to have the meaning ascribed to it. It is unlikely that *Sharp* will be challenged or overturned in the near future. But it is important to note that many problems arising could be appropriately addressed by adopting a full ownership approach to attachment, and by separating the floating charge's attachment from its enforcement. This would also have met the policy concerns in *Sharp* by allowing for the same outcome in the circumstances of the case.

E. ATTACHMENT AND HERITABLE SECURITIES

(1) Standard Security

Since the introduction of the 1970 Act, the standard security is the only heritable security that can be granted “over land or a real right in land”.⁷⁹⁰ Although it can affect such property, a floating charge is not, strictly speaking, a heritable security as it cannot be recorded in the GRS or registered in the Land Register.⁷⁹¹

Where property is subject to a standard security, the position for the attachment of the floating charge is straightforward. The secured property remains in the chargor's patrimony, as the standard security is only a subordinate real right in security. The charge can therefore still attach and the interrelationship with the standard security is determined by ranking rules.⁷⁹² (The standard security is a fixed security within the floating charges legislation.)⁷⁹³ This is true whether the standard security was granted before the floating charge's creation or afterwards.

⁷⁹⁰ 1970 Act, s 9(3). (This was originally expressed in the legislation as the sole heritable security grantable “over an interest in land”.) It is therefore the only heritable security available over long leases and standard securities, as well as ownership of land.

⁷⁹¹ Ibid, s 9(8)(a): “heritable security” “means any security capable of being constituted over any land or real right in land by disposition or assignation of that land or real right in security of any debt and of being registered in the Land Register of Scotland or recorded in the Register of Sasines”.

⁷⁹² 1985 Act, s 464(1), (1A), (4)(a).

⁷⁹³ Ibid, s 486(1); 1986 Act, s 70(1). These definitions include a heritable security in terms of the 1970 Act.

(2) Bond and Disposition in Security

Before the 1970 Act, it was possible to create other types of heritable security.⁷⁹⁴ The most notable of these were the bond and disposition in security and the *ex facie* absolute disposition qualified by back letter or agreement.⁷⁹⁵ By the time the floating charge was introduced, it was widely accepted that a bond and disposition in security was non-divestive and amounted to a real right in security over the debtor's heritable property in favour of the creditor.⁷⁹⁶ Consequently, if property was subject to a bond and disposition in security, a floating charge granted by the debtor could clearly attach to it.

As a real right in security over a company's property, effective in a liquidation, a bond and disposition in security was classifiable as a fixed security in the floating charges legislation and this seems to have been intended in the 1961 Act (see below). It would therefore rank against the floating charge according to this status.

(3) *Ex Facie* Absolute Disposition in Security

Far more problematic is the type of heritable security that was most common immediately before the 1970 Act;⁷⁹⁷ the *ex facie* absolute disposition qualified by back letter or other agreement. This was a disposition which, on the face of the deed, appeared to be an absolute transfer of title but there was a separate non-registered document disclosing the true secured purpose of the transaction.⁷⁹⁸

⁷⁹⁴ It is still technically possible for there to be an *ex facie* absolute disposition or bond and disposition in security in competition with a floating charge, if the security was created before the 1970 Act and continues to exist.

⁷⁹⁵ For details of these securities, and others, see *Halliday's Conveyancing*, vol 2, chs 47ff; WM Gordon, *Scottish Land Law*, 2nd edn (1999), ch 20; and Gloag and Irvine, *Security*, chs 2ff. The cash credit bond and disposition in security can be considered a variant of the bond and disposition in security – see eg Gloag and Irvine, 69f; Halliday, paras 48-72ff; Gordon, paras 20-84f.

⁷⁹⁶ See Gretton, "Radical Rights" at 54 and below. See also eg Gloag and Irvine, *Security*, 66ff, where they compare a bond and disposition in security to a pledge. Goudy, *Bankruptcy*, 546f, notes a creditor with a bond in disposition is an "incumbrancer merely" and that the creditor (with one partial exception for poiding of the ground) is not restricted in his usual remedies, if his debtor is in sequestration. The same would most probably have been considered to apply to liquidation too.

⁷⁹⁷ *Halliday's Conveyancing*, vol 2, para 49-01. One of the reasons for its emergence was its ability to act as a security for debts of an uncertain amount and for future debts: see Gloag and Irvine, *Security*, 142. Cf the position for the bond and disposition in security.

⁷⁹⁸ If a back bond was registered, the creditor's interest would be treated more like an express security right: Gloag and Irvine, *Security*, 155ff. See also the Reversion Act 1469, which gave the reverser in a bond of reversion a real right, but which required to be registered for this effect after the Registration

(a) Nature

When the floating charge was introduced, the nature of the *ex facie* absolute disposition had not been definitively settled. The disposing debtor either: (i) was fully divested of the property disposed in security, retaining only a personal right to have the subjects reconveyed upon satisfaction of the debt; or (ii) had a right directly in the property secured, often referred to as a “radical right”. There had even been earlier debates as to whether a *bond and disposition in security* involved divestment of the debtor. Professor Gretton identifies three broad (historical) schools of thought regarding whether a debtor in a heritable security was divested.⁷⁹⁹ The two polar positions were the functionalists, who viewed all securities as non-divestive of ownership for the debtor whatever their form (a full application of the radical right doctrine), and the formalists, who considered the securities according to their form, so that the references to transfer within deeds should be given effect to even though the deed disclosed the purpose of the transfer. Finally, the compromisers adopted a middle ground by viewing transfers expressly in security (eg a bond and disposition in security) as non-divestive of the debtor while transfers *ex facie* absolute were considered non-divestive.

Approach	Bond and Disposition in Security		<i>Ex Facie</i> Absolute Disposition	
	Debtor	Creditor	Debtor	Creditor
Functionalists	Ownership	Security Right	Ownership	Security Right
Formalists	Personal Right	Ownership	Personal Right	Ownership
Compromisers	Ownership	Security Right	Personal Right	Ownership

Act 1617; and see Reid, *Property* (Gretton), para 112. The 1469 Act was repealed by the Title Conditions (Scotland) Act 2003, s 89(1).

⁷⁹⁹ Gretton, “Radical Rights”, especially at 202ff. See also GL Gretton, “*Ex Facie* Absolute Dispositions and their Discharge: Exhumation” (1979) 24 JLSS 462; and the reply by JM Halliday, “*Ex Facie* Absolute Dispositions and their Discharge: Post-Exhumation” (1980) 25 JLSS 54.

As Gretton notes, the compromisers' position was eventually accepted. The formalist view was finally discarded in *Campbell v Bertram*,⁸⁰⁰ with the court appearing to adopt the compromise perspective.⁸⁰¹ And, earlier, in *Gardyne v Royal Bank of Scotland*,⁸⁰² it had been held that a disposition *ex facie* absolute *did* divest the grantor, and was consequently a rejection of the functionalist position. This was followed by a number of cases adopting the same position, most notably *National Bank v Union Bank*.⁸⁰³

However, later *obiter dicta* from Lord Kinnear in *Ritchie v Scott*,⁸⁰⁴ in which he stated that a disposition *ex facie* absolute did not divest the grantor, created some uncertainty, particularly as there were subsequent cases in which his position was followed.⁸⁰⁵ This created a dichotomy between the compromise approach and the functional approach; otherwise known as the “weak form” and “strong form” of the radical rights doctrine respectively.⁸⁰⁶

As Professor Gretton makes clear, however, Lord Kinnear's position was based upon an incorrect interpretation of trust law and is at odds with a considerable depth and range of authorities favouring the weak form of the radical rights doctrine, including the view of Lord Reid in a later House of Lords case.⁸⁰⁷ In addition, Gretton points out that Lord Kinnear reverted to the orthodox weak form position in *Inglis v Wilson*.⁸⁰⁸ This had, however, been overlooked in later cases where Lord Kinnear's earlier position was adopted instead. The

⁸⁰⁰ (1865) 4 M 23. Although, as Gretton, “Radical Rights” at 54, n 12, notes, there were, exceptionally, still some adherents to the formalist position much later: see Smith, *Short Commentary*, 558, n 60, who states that in a bond and disposition in security “title is in the disponee alone”.

⁸⁰¹ The compromise position was earlier supported by Stair, II, 10, 1: see GL Gretton, “Radical Rights” at 203.

⁸⁰² (1851) 13 D 912; at (1853) 15 D (HL) 45 the decision was reversed by the House of Lords but on a different point. See also *Hamilton v Western Bank* (1856) 19 D 152 per Lord Ivory at 162, where the divesting effect of such security was recognised and discussed in the context of equivalent security for other property types.

⁸⁰³ (1885) 13 R 380. The House of Lords reversed the decision on another basis but confirmed the divesting effect of dispositions *ex facie* absolute ((1886) 14 R (HL) 1). For further authorities, see Gretton, “Radical Rights” at 204, n 38.

⁸⁰⁴ (1899) 1 F 728 per Lord Kinnear at 736.

⁸⁰⁵ See *Edinburgh Entertainments* (n 44) per LJC Alness at 375f; and *Scobie v Wm Lind & Co* 1967 SLT 9.

⁸⁰⁶ Gretton, “Radical Rights” at 54f.

⁸⁰⁷ *Aberdeen Trades Council v Shipconstructors and Shipwrights Association* 1949 SC (HL) 45 per Lord Reid at 63ff; see Gretton, “Radical Rights” at 208.

⁸⁰⁸ 1909 SC 1393 at 1402f; Reid, *Property* (Gretton), para 112, n 15. And see J Burgoyne, “Heritable Securities” in *SME*, vol 20 (1992), para 133, who also conforms to the divestment approach.

ultimate success of the compromiser view was highlighted in the relatively recent Outer House case of *Sexton v Coia*.⁸⁰⁹

Nevertheless, the functionalist position was still relatively widespread when the floating charge was introduced. Professor Halliday was an adherent of that position, due to Lord Kinneir's earlier *dicta* and certain subsequent authorities, despite being ideologically opposed to it.⁸¹⁰ Indeed, Halliday acknowledged that the 1970 Act was enacted against the background of the Lord Kinneir theory and the draftsman "undoubtedly assumed the validity" of that theory.⁸¹¹ Of course, Halliday was also involved with the introduction of the floating charge, as he provided conveyancing expertise to the LRCS.⁸¹² The functionalist approach therefore almost certainly also influenced Halliday and others when they were considering the relationship between the charge and security by *ex facie* absolute disposition.

The different theories also impact upon how property disposed *ex facie* absolutely is dealt with in insolvency. If the disponent is fully divested then it is difficult to justify property being dealt with as part of its insolvent estate. Under that approach, it is more plausible for the entirety of the disposed property to fall within the *disponee's* estate and therefore to be available to *its* creditors. However, in the insolvency context, a number of authorities seem to lean towards a functionalist position. *Heritable Reversionary* led Goudy to conclude that a trustee in sequestration takes property, held in security on an *ex facie* absolute title, subject to the disponent's contract with the "true and radical owner, and with no larger rights than the bankrupt himself possessed".⁸¹³ This would allow for priority in the property up to the value

⁸⁰⁹ 2004 GWD 17-376 and 2004 GWD 38-781, in which Lord Kinneir's earlier view was expressly rejected by Lord Emslie. See also *MacKenzie Petr* 1979 SLT (Sh Ct) 68.

⁸¹⁰ See JM Halliday, "The *Ex Facie* Absolute Disposition" (1957) 1 ConvRev 5; JM Halliday, *The Conveyancing and Feudal Reform (Scotland) Act 1970*, 2nd edn (1977), para 6-29; Halliday (n 799) at 54. Halliday did, however, consider that there *would* be outright transfer if eg A sold to B but before B was infert he disposed to his creditor C *ex facie* absolutely, or if the transfer was directly, and *ex facie* absolutely, from A to C, with the consent of B, but C held the property as B's creditor (see eg (1957) 1 ConvRev 5 at 5 and (1977), para 6-31).

⁸¹¹ Halliday (n 799) at 54.

⁸¹² See 162.

⁸¹³ Goudy, *Bankruptcy*, 265. Also note his criticism (at 1891 JR 365) of the First Division's decision in *Heritable Reversionary* (1891) 18 R 1166, which was reversed by the House of Lords (Goudy having appeared as counsel for the appellants). Goudy pointed out (at 366) that the First Division's decision would mean that the whole secured property would be available to the security holder's creditors as part of the bankrupt estate and the "true owner" would only rank as a personal creditor by virtue of the re-conveyance right.

of the debt due to the disponee.⁸¹⁴ *Forbes's Trustees v MacLeod*⁸¹⁵ also supports this analysis. A bond and disposition in security was assigned *ex facie* absolutely and recorded but a back letter revealing the security nature of the transaction was provided. The debt had been repaid when the assignee's sequestration occurred. Lord McLaren considered that the trustee in sequestration was bound to retransfer the property, noting that *Heritable Reversionary* applied to security titles in addition to trusts and that "even where the title is *ex facie* unqualified and enters the record as such, the creditors of the *ex facie* absolute proprietor can take no higher right than he himself possessed".⁸¹⁶

Gloag and Irvine, meanwhile, identify the uncertainty regarding whether the sequestration of an *ex facie* absolute disponee would enable the trustee in sequestration to obtain the disposed subjects.⁸¹⁷ They consider that the disponee "has a real and beneficial interest in the property", for the debts secured, but suggest that the ratio of *Heritable Reversionary* would probably extend to a disponee *ex facie* absolute and mean that the property is not the "property of the debtor".⁸¹⁸ These same conclusions would probably have also been applied by the authors, and the court in *Forbes's Trustees*, to liquidation. Such authorities do, however, derive from the height of English influence on property law in Scotland.⁸¹⁹ It seems highly likely that a modern court would take a different view, and one more in line with the divestment approach.⁸²⁰

⁸¹⁴ However, Goudy, *Bankruptcy*, 265, also notes that it is necessary to distinguish cases where the bankrupt's right is the "real beneficial right of ownership" and where that party is only under some personal obligation, such as a *pactum de retrovendendo*.

⁸¹⁵ (1898) 25 R 1012.

⁸¹⁶ At 1015. This case was cited by Lord Jauncey in *Sharp* at 73.

⁸¹⁷ Gloag and Irvine, *Security*, 152f.

⁸¹⁸ *Ibid*, 153.

⁸¹⁹ See eg Reid (n 660) at 468.

⁸²⁰ Reid, *Property*, para 694. The related doctrine of *tantum et tale*, whereby particular claims relating to the debtor and his property can also be raised against that party's trustee in sequestration or diligence creditors, is much diminished in modern law (see *Burnett's Tr*). For discussion, see J MacLeod, "Fraud and Voidable Transfer: Scots Law in European Context" (PhD Thesis, University of Edinburgh) (2013), ch 8. In addition, there is authority that *tantum et tale* does not apply to the liquidation of a company, as unlike with a trustee in sequestration, property does not transfer to the liquidator: *Hutchison, Main & Co* (n 610), per Lord Kinnear at 5f. See also RG Anderson, "Fraud on Transfer and on Insolvency: *Ta...Ta...Tantum et Tale?*" (2007) 11 *EdinLR* 187 at 203f, who notes the connection between the equitable and latent rights inherent in *tantum et tale* and the "beneficial interest" doctrine espoused in *Heritable Reversionary* and suggests that "the only way to deal with the *Heritable Reversionary* doctrine is to extirpate it".

(b) A Fixed Security?

It is now necessary to examine the extent to which the *ex facie* absolute disposition was incorporated into the statutory framework for floating charges. This helps us determine how that heritable security and the charge were expected to interact.

(i) Definition

Since the 1972 Act, the definition of “fixed security” in the floating charges legislation has referred to the 1970 Act, under which the standard security is the only heritable security that may be created.⁸²¹ In the 1961 Act the definition was the same as the current definition except in one respect. Instead of a reference to the 1970 Act, after the generality of the earlier part of the definition, it stated that the term “includes a security over... property created by way of an *ex facie* absolute disposition or assignation qualified by a back letter”.⁸²² This definition was effective throughout the 1961 Act and therefore applied to: the floating charge being subject to, *inter alia*, a fixed security ranking ahead of it;⁸²³ the provision regarding the effect of a floating charge upon attachment “as if” it were a fixed security over the property to which it attached;⁸²⁴ and the provisions referring to the circumstances in which fixed securities ranked ahead of or behind the floating charge.⁸²⁵ A security over property created by *ex facie* absolute disposition or assignation qualified by back letter therefore has relevance in each of these contexts.

During the progress of the Bill that became the 1961 Act, Forbes Hendry MP stated that “fixed security” was “any security other than a floating charge” and then noted that the definition proceeded to “define in rather greater particularity certain types of heritable security about which there might be some doubts”.⁸²⁶ This recognised the uncertain status of the *ex facie* absolute disposition qualified by back letter. It was also an acknowledgement that the reference to assignation *ex facie* absolute qualified by back letter was principally to heritable

⁸²¹ 1972 Act, s 31(1). And see above.

⁸²² 1961 Act, s 8(1)(c). It must be assumed that the reference to *ex facie* absolute disposition or assignation in the definition included the recording, or equivalent, for these securities. The alternative would be absurd.

⁸²³ *Ibid*, s 1(2)(b).

⁸²⁴ *Ibid*, s 1(2).

⁸²⁵ *Ibid*, ss 5(1) and (2).

⁸²⁶ Scottish Standing Committee, 20 June 1961, col 16.

property, for example leases.⁸²⁷ This was confirmed too by the Bill's promoter in the House of Lords, Viscount Colville of Culross, who specified that two means of security were available for heritable property: firstly "...by way of an *ex facie* absolute disposition or assignation qualified by a back letter" and, alternatively, by a "bond of disposition for security [sic]".⁸²⁸ The bond and disposition in security was clearly recognised as a fixed security and it was not deemed necessary for it to be expressly included in the definition. Hendry referred to it as the "commonest"⁸²⁹ type of security over heritage and also noted that where a bond and disposition in security had been granted over a factory, and the grantor then wished to create a floating charge, the former must have priority.⁸³⁰ This priority ranking would be realised by the bond and disposition in security being a fixed security. The absence of doubt about its status as a fixed security presumably stemmed from the fact the deed expressly stated that it was a security, and its accepted nature as a non-divestive security right also created few difficulties on this front. The position in both respects was different for the *ex facie* absolute disposition.

The inclusion of *ex facie* absolute dispositions (and assignations) represented an adoption of the functionalist position in the floating charges legislation. In relation to these securities, Forbes Hendry noted that, because the document stated it was an absolute disposition to the creditor, "the property appears to cease to be the property of its beneficial owner, and to become the property of the bank or other creditor".⁸³¹ If such securities had not been expressly included in the definition of fixed security, there would have been a risk that they would not have fallen under the definition, thus causing problems regarding their interaction with floating charges. In statutory interpretation, "include" may extend a term (such as fixed security) beyond the meaning it would naturally bear, so as to incorporate expressly mentioned items which would not, or might not, ordinarily be included.⁸³²

⁸²⁷ See also the mention of this type of security as a "charge on land" requiring registration in the 1948 Act, s 106A(2)(a), inserted by the 1961 Act, Second Schedule. See also Gloag and Irvine, *Security*, ch 6, for details of the assignation of leases in security.

⁸²⁸ HL Deb, 5 July 1961, vol 232, cols 1434-1435.

⁸²⁹ This seems to have been true at the end of the previous century: Gloag and Irvine, *Security*, 66. But it was apparently not the most commonly granted heritable security by 1961 (see 195 above).

⁸³⁰ Scottish Standing Committee, 20 June 1961, cols 10 and 12.

⁸³¹ *Ibid*, col 33.

⁸³² See *Robinson v Barton-Eccles Local Board* (1883) 8 App Cas 798, HL, per Selbourne LC at 801; *Dilworth v Stamps Comrs* [1899] AC 99, PC, per Lord Watson at 105f; JF Wallace, "Interpretation of Statutes" in *SME*, vol 12 (1992), para 1140. This can be described as an "enlarging definition": Jones, *Bennion on Statutory Interpretation* (n 15), 517 and 526ff.

(ii) Attachment Problems

There seems to have been an assumption that the floating charge and *ex facie* absolute disposition would be able to rank against one another, due to the deemed non-divestive effect of the latter. However, given that the compromise approach ultimately prevailed, we need to consider the relationship between the floating charge and the *ex facie* absolute disposition in that context. If we do so, it seems that the floating charge could not attach to property subject to such a disposition. For example, take the following sequence of events: (i) A Ltd granted a floating charge to B Bank over all its property; (ii) A Ltd disposed heritable property *ex facie* absolutely, but qualified by back letter, to C Bank and the disposition was recorded; (iii) A Ltd entered liquidation and B Bank’s floating charge attached.

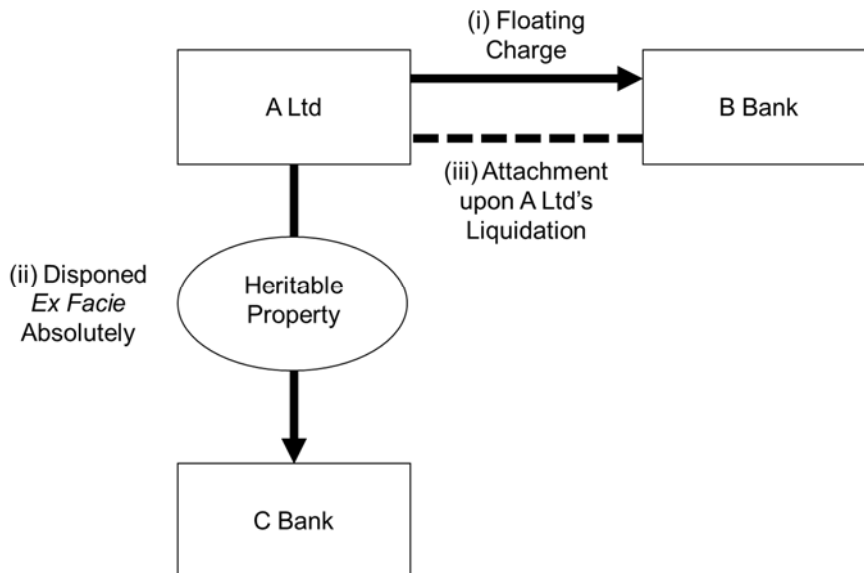

A Ltd would have been divested at (ii) (unless we adopt an equitable approach to the meaning of “property and undertaking” and thus the charge’s attachment). Consequently, B Bank’s charge would not have attached to the property (except if the property was reconveyed to A Ltd). The effect would be the same if property was transferred outright to another, except that where the property was disposed *ex facie* absolutely but qualified by back letter the charge would attach to A Ltd’s personal right to reconveyance upon satisfaction of the debt due to C Bank.

The potential difference in the effects of the transfer of ownership as a security and the creation of a real right in security highlights one of the fundamental elements of a floating charge. The greater step of transfer of ownership renders a floating charge inoperable against the property, while the lesser step of granting a real security right does not.⁸³³ This is different from, for example, a standard security, which continues to affect property if that property is sold by the debtor. The varying effects with respect to the floating charge demonstrate an issue for the charge's operation where parties have a choice of security rights, where one transfers ownership and the other only creates a real security right.

The paradox involving the apparent non-attachment and intended ranking relationship would have been less of a problem where the *ex facie* absolute disposition ranked ahead of the charge.⁸³⁴ In that instance, a charge would attach to the disponent's reversionary right and the floating charge would be subject to the rights of the disponent anyway. The disponent could have realised and would need to return surplus proceeds to the company, which would have enabled the chargeholder to obtain its priority. The only problem might have been where the disponent became insolvent and its creditors claimed against the property.⁸³⁵ More difficult would have been where the charge ranked ahead of the disponent due to it having been created first, with a negative pledge clause, and registered in the charges register prior to the creation of the fixed security.⁸³⁶ How would the chargeholder have practically obtained its priority? How could the liquidator acting for the chargeholder (and others) have realised the property, if the property did not fall into the liquidation? This problem could have been solved by reading the prohibition on the creation of prior (or equal) ranking fixed securities as invalidating the divestment effect of securities that were created after the charge's registration.⁸³⁷ But this in turn would have created difficulties regarding transfers by the disponent and with respect to those who relied on that party's absolute title. And it was later clarified that a floating charge with negative pledge simply "confer[s] priority" over

⁸³³ However, the fixed security would rank ahead if the floating charge does not include a negative pledge.

⁸³⁴ But note that ranking could only formally arise if the charge attached.

⁸³⁵ In contrast to the likely position in current law, see the authorities above suggesting any such claims would be limited to the debt due. See also Stewart, *Diligence*, 606, who states that the estate can be adjudged by the creditors of the disponent, citing *Livingston v Lord Forrester's Heirs* (1664) Mor 10200, where creditors of a party holding land in trust (only in part for his own benefit) were granted an adjudication of the land by the court, but this was to be burdened by a back bond. Stewart (at 606) also notes that the creditors of a "beneficial owner" may attach *his* right by adjudication, whether that right is "absolute or merely reversionary" (and cites cases in support).

⁸³⁶ 1961 Act, s 5(2).

⁸³⁷ *Ibid*, s 5(2)(c).

subsequently created prohibited securities.⁸³⁸ This suggests a ranking priority predicated on the floating charge attaching.

The compromise position also fatally undermines the view that the floating charge takes on the nature of particular types of security right when it attaches. The charge attaches “as if” it is a fixed security, yet the *ex facie* absolute disposition qualified by back letter and bond and disposition in security were both fixed securities. The attached charge, in relation to heritable property, cannot simultaneously have had a deemed divestive effect, like an *ex facie* absolute disposition, and a real security right effect, akin to a bond and disposition in security, prior to the introduction of the standard security. This shows that the prevailing view of the statutory hypothesis would have been illogical when the charge (and the hypothesis) were introduced, and is thus a significant point in favour of the attachment mechanism being *sui generis*.⁸³⁹

As mentioned previously, Professor Wilson indicated that there might be problems involving the floating charge and dispositions *ex facie* absolute.⁸⁴⁰ The above discussions show that he was correct. The attempt to fit these securities together demonstrates the difficulties introducing a new form of security which has to interact with existing security rights, the nature of which are unclear and disputed. If a case arose concerning the attachment of a floating charge to property disposed *ex facie* absolutely, then it is likely that the statutory provision would have bolstered the functionalist argument, not only for floating charges but more widely.⁸⁴¹ This last point is supported by the fact that the definition of fixed security refers to security in relation to “property of a company” which would be “treated as an effective security over that property” upon the company’s winding up.⁸⁴² Given this, and the potential impossibility of enforcement by a chargeholder if property is not deemed to fall into the chargor’s liquidation, it is plausible that the property would have been considered to be within the chargor’s liquidation to facilitate the express ranking rules.⁸⁴³

⁸³⁸ See 1985 Act, s 464(1A), which was inserted by the Companies Act 1989, s 140(4). A reference to the prohibition of later prior (or equal) ranking floating charges (not just fixed securities) was included in the 1972 Act, s 5(1), and see now 1985 Act, s 464(1)(a).

⁸³⁹ See chapter 5 for more details.

⁸⁴⁰ Wilson (n 640) at 66.

⁸⁴¹ This potentially remains true for assignation in security: see chapter 9.

⁸⁴² 1985 Act, s 486(1); 1986 Act, s 70(1).

⁸⁴³ The difficulties accommodating and explaining *ex facie* absolute dispositions more widely in Scots law were identified in the Inner House in *Sharp* (at 485, 493 and 503f).

If the compromise position is accepted for *ex facie* absolute dispositions generally, the floating charge is an example of an institution intended to interact with a misconstrued version of the existing law. Does this mean that the floating charge should be interpreted according to a seemingly incorrect version of Scots property law, and therefore a charge *could* attach to property the chargor had disposed *ex facie* absolutely? Or should it be considered to respond to changing views as to the correct position, so that if the chargor disposed property *ex facie* absolutely, a charge could only attach to the personal reversionary right?

The two possible interpretations again relate to the issue of integrationism against exceptionalism for the charge and its relationship with Scots law. If the floating charge is not responsive then, over time, it becomes more exceptional and the challenges to make it coherent with property law are intensified. It is possible to read the decision and implications of *Sharp* in this way.⁸⁴⁴ However, if the alternative approach is taken, there can be unintended consequences for the charge-property dynamic, and the charge may lose its function in certain circumstances. For example, the charge would not be able to rank directly against an *ex facie* absolute disposition.

Nevertheless, integrationism seems more appropriate here; terms in legislation should be expected to alter, expand and contract in line with wider law. As Bennion states, Acts are usually “intended to develop in meaning with developing circumstances...”⁸⁴⁵ The presumption is that Parliament intends that such an Act receives a construction which updates it against background changes: “though necessarily embedded in its own time, [it] is nevertheless to be construed in accordance with the need to treat it as current law.”⁸⁴⁶ This could mean that property disposed by a chargor *ex facie* absolutely would not be within that company’s “property and undertaking” and thus would not be attachable by the floating charge. But, again, the existence of *Sharp* throws this assertion into doubt, as a full equitable attachment approach *would* enable attachment to take place.

⁸⁴⁴ The case was decided against the background of some general uncertainty in Scots law regarding the nature of transfer of ownership of heritable property. But, subsequently, the Scots law position has been clarified while the law of floating charges, due to *Sharp*, is different.

⁸⁴⁵ FAR Bennion, *Understanding Common Law Legislation: Drafting and Interpretation* (2001), 57.

⁸⁴⁶ *Ibid.*

CHAPTER 8

THE FLOATING CHARGE AND CORPOREAL MOVEABLE PROPERTY

A.	INTRODUCTION	207
B.	ATTACHMENT AND TRANSFER	208
(1)	General Position.....	208
(2)	<i>Sharp v Thomson</i>	212
(3)	The Wilson Analysis	214
C.	ATTACHMENT AND SECURITY RIGHTS	216
(1)	Pledge	216
(2)	Transfer of Ownership as Security.....	217
(3)	Retention of Title.....	223
(4)	Tacit Security.....	230

A. INTRODUCTION

At common law the creation of a voluntary security right over corporeal moveable property requires delivery to the grantee.⁸⁴⁷ The introduction of alternatives that comply with the publicity principle has been a challenge, albeit that registration is used to create security over certain discrete types of property.⁸⁴⁸ The floating charge was largely a response to the impracticalities of giving and taking security over corporeal moveables in Scots law. This is

⁸⁴⁷ The recognised subordinate real right is pledge (see below). There are limited exceptions to the delivery requirement: bonds of bottomry and respondentia (for maritime property), which are now practically obsolete. For the history of real security over moveables in Scots law, see AJM Steven, “Rights in Security over Moveables” in Reid and Zimmermann, *History*, vol 1, ch 8.

⁸⁴⁸ Eg ship and aircraft mortgages, which have to be registered: see Merchant Shipping Act 1995, s 16(1) and Sch 1, paras 7-13 (and formerly Merchant Shipping Act 1894, ss 31-46); Civil Aviation Act 1982, s 86; Mortgaging of Aircraft Order 1972/1268. These provide principally UK-wide regimes. International security interests over aircraft objects are now available under the International Interests in Aircraft Equipment (Cape Town Convention) Regulations 2015/912. For recent discussion of the law of ships, see GL Gretton, “Ships as a Branch of Property Law” in ARC Simpson et al (eds), *Continuity, Change and Pragmatism in the Law: Essays in Memory of Professor Angelo Forte* (2016), 394ff. The SLC have proposed introducing a new Register of Moveable Transactions which would be used for, *inter alia*, the creation of security rights over moveable property (including corporeal moveables): see SLC, *Moveable Transactions*, especially paras 3.2ff.

evidenced by the practical issues that led to the LRCS's reform project and its recommendations, and TB Smith's Historical Note appended to the *Eighth Report*, which focused upon the history of non-possessory security rights over corporeal moveables.⁸⁴⁹ It is, therefore, perhaps not surprising that problems involving this category of property and the floating charge are less apparent than for other property types. There are still, however, areas of uncertainty.

This chapter will examine when corporeal moveables leave the "property and undertaking" of a chargor and become unattachable. Within the context of transfer of ownership, attention will be given to the potential implications of *Sharp* for corporeal moveables as well as to Professor Wilson's analysis of when attachment is no longer possible. The final part of the chapter will consider attachment where the property is subject to other types of security: the voluntary real security of pledge, the functional securities of retention of title and transfer of ownership as a security device, and tacit securities. There are few cases involving the attachment of the floating charge to corporeal moveable property and associated ranking issues. As such, it is necessary to draw upon general principles and extrapolate rules relevant to other property types, as well as to use the limited volume of secondary literature available on the relationship between floating charges and corporeal moveables.

B. ATTACHMENT AND TRANSFER

(1) General Position

In general terms, when a party that has granted a floating charge owns corporeal moveable property, the charge can attach to that property as it is within the company's "property and undertaking". Once ownership is transferred to another, the floating charge can no longer attach.⁸⁵⁰ At common law, delivery of corporeal moveables is necessary to transfer ownership. The precise form of the required delivery is not entirely certain, but extends beyond actual delivery to symbolical and constructive delivery in certain circumstances.⁸⁵¹ In addition, it is possible for parties to include further conditions (beyond the requirement of delivery) which

⁸⁴⁹ See eg *Eighth Report*, paras 5ff; and Appendix 1.

⁸⁵⁰ This is also the position adopted by Rennie (n 11), 25f, as regards corporeal moveables.

⁸⁵¹ For detailed analysis see eg Carey Miller, *Corporeal Moveables*, paras 8-12ff. Cf Anderson, *Possession*, ch 6.

must be fulfilled before ownership transfers.⁸⁵² The common law still applies to donation,⁸⁵³ exchange (excambion) and transactions in the form of a contract of sale intended to operate as security.⁸⁵⁴

Nevertheless, goods⁸⁵⁵ are far more commonly transferred by a sale under the provisions of the 1979 Act, and formerly the 1893 Act. The traditional meaning of “sale” in Scots law was “a contract for transferring property in consideration of a price in money”.⁸⁵⁶ The 1893 Act, under the influence of English law, used “sale” to mean the transfer of ownership in exchange for a monetary price.⁸⁵⁷ In relation to contracts of sale, a contrast was drawn between a sale, under which property transfers, with an agreement to sell, where “the transfer of the property in the goods is to take place at a future time or subject to some condition thereafter to be fulfilled”.⁸⁵⁸ The 1893 Act allowed for ownership of goods to transfer when the parties intended for it to do so, even if delivery had not taken place.⁸⁵⁹ All of this has been repeated within the 1979 Act.⁸⁶⁰

To determine when the parties intend ownership to pass, regard is to be had to the contractual terms, the parties’ conduct and the circumstances of the case.⁸⁶¹ This means that if A Ltd and C Ltd have agreed that the ownership of widgets will pass upon C Ltd paying the price, that

⁸⁵² See eg *Michelin Tyre Co Ltd v Macfarlane (Glasgow) Ltd* 1917 2 SLT 205, HL; Reid, *Property (Gamble)*, para 638; Sim, “Rights in Security”, paras 29ff. And see n 920 below.

⁸⁵³ This is possible but unlikely for a company and such transfers could be challenged as gratuitous alienations.

⁸⁵⁴ Where the latter is the case, the 1979 Act, s 62(4), disapplies the provisions in the Act about contracts of sale. See 217ff below.

⁸⁵⁵ Defined under s 62(1) of the 1893 Act and, now, under the 1979 Act, s 61(1), as (in Scotland) “all corporeal moveables except money”.

⁸⁵⁶ Bell, *Commentaries*, I, 434. See also R Brown, *Treatise on the Sale of Goods with Special Reference to the Law of Scotland*, 2nd edn (1911), xi-xii and 2ff, who compares the traditional Scottish and English definitions of sale. The same distinction is also drawn in *Bell’s Dictionary*, 935.

⁸⁵⁷ 1893 Act, s 1(1) and (3), and now 1979 Act, s 2(1) and (4); and see Brown, *Sale of Goods* (n 856), xi-xii and 2ff.

⁸⁵⁸ 1893 Act, s 1(3), and now 1979 Act, s 2(4) and (5), where “thereafter” has been replaced by “later”.

⁸⁵⁹ 1893 Act, ss 16ff. For discussion, see Brown, *Sale of Goods* (n 856), 2ff and 112ff. For a pre-Act treatise on sale, see MP Brown, *A Treatise on the Law of Sale* (1821). See also the Mercantile Law Amendment (Scotland) Act 1856, most of which is now repealed.

⁸⁶⁰ For the 1979 Act, see ss 16ff, especially s 17(1) for the general rule regarding intention. See also Reid, *Property (Gamble)*, paras 624ff; and Carey Miller, *Corporeal Moveables*, ch 9. To determine when ownership of goods is transferred in consumer contracts covered by the Consumer Rights Act 2015, s 4(2) of that Act provides that the 1979 Act, ss 16-20B, should be referred to. For discussion of the 2015 Act, see WCH Ervine, *Consumer Law in Scotland*, 5th edn (2015).

⁸⁶¹ 1979 Act, s 17(2).

is when ownership will transfer.⁸⁶² If A Ltd and C Ltd have granted floating charges to B Bank and D Bank respectively, those charges will generally attach to the rights held by the corresponding chargor.

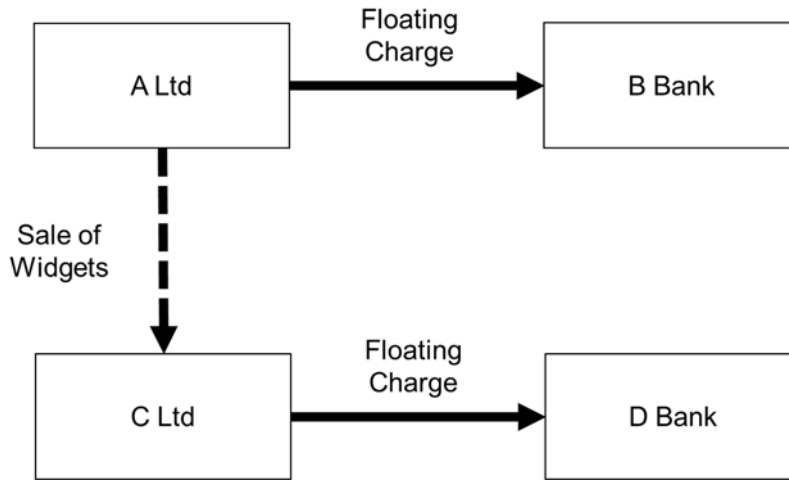

Therefore, until ownership transfers to C Ltd, B Bank’s charge could attach to the widgets and any personal rights A Ltd has against C Ltd, and C Ltd’s personal rights against A Ltd would be attachable by D Bank’s charge. Once ownership of the widgets transfers, D Bank’s charge could attach to C Ltd’s ownership right.

The 1979 Act also provides various default rules to determine intention, where it is not apparent.⁸⁶³ For example, the first rule is that if there is “an unconditional contract for the sale of specific goods in a deliverable state” ownership (“property”) passes when the contract is made.⁸⁶⁴ It is irrelevant whether payment and/or delivery are delayed. In each case, property ceases to become attachable by a seller-granted floating charge once ownership transfers. And the 1979 Act outlines when the transfer of ownership takes place.⁸⁶⁵

⁸⁶² Assuming the property is ascertained: see 1979 Act, s 16.

⁸⁶³ 1979 Act, s 18.

⁸⁶⁴ Regarding the meaning of “property”, cf the views expressed by TB Smith in: “Property Problems in Sale: Three Footnotes” 1987 SLT (News) 241; and *Property Problems in Sale* (1978), 49ff.

⁸⁶⁵ The situation of undivided shares in goods in a bulk is interesting. If payment is made by the buyer, the default rule is that it becomes a co-owner of the bulk (1979 Act, s 20A). This would mean that B Bank and D Bank’s charges could both attach to the bulk, but only to their chargor’s respective shares in common.

The chargor's ownership of property should, generally, be considered a necessary and sufficient requirement for the attachment of the charge to corporeal moveable property (and other property).⁸⁶⁶ (The possibility of *Sharp* representing an exception in certain transfer scenarios is discussed below.) The general position also seems to be supported by comments made in Parliament about the Bill that became the 1961 Act. In the Scottish Standing Committee, the Lord Advocate⁸⁶⁷ used the example of a sale of a red tie by a draper's shop that "had a floating charge" to explain the operation of such a security.⁸⁶⁸ He stated that "once the tie was sold...it was [the buyer's] property and was not subject to the floating charge".⁸⁶⁹

However, additional comments by the Lord Advocate raise doubts as to how he expected the floating charge to function. He said that if the tie "was left in the draper's shop and it had not been paid for, it would be subject to the floating charge" upon liquidation of the selling company. He also stated that if a drapery company granted a floating charge over its assets and a purchaser did not "take delivery of his tie" then "so long as it is in the shop it is subject to the floating charge".⁸⁷⁰ While the absence of delivery at common law would have meant ownership remained with the seller, this is not true under the Sale of Goods legislation. There is also a possible contradiction between the first additional comment where it is suggested that payment *and* delivery would prevent a seller-granted charge from attaching, and the second one where only delivery may be required for non-attachability. It is possible that the Lord Advocate had in mind situations in which the parties agreed that ownership would only pass upon payment and/or delivery, and such designated transfer points *are* commonplace. The first one could, alternatively, be an allusion to the seller's statutory lien,⁸⁷¹ but it would be the lien right that a charge would attach, not the property (ownership). More generally, the requirement for the charge to be enforced in liquidation would suggest that the property would only be attachable by a seller-granted charge, as long as ownership remained with the seller.

⁸⁶⁶ This aligns with the full ownership attachment approach: see 93ff.

⁸⁶⁷ William (later Lord) Grant (1909-1972). For brief biographical details see *The Times*, 21 November 1972, 17. Forbes Hendry was the promoter in the House of Commons but received assistance from the Lord Advocate.

⁸⁶⁸ Scottish Standing Committee, 20 June 1961, col 8. By saying the shop "had" a floating charge, the Lord Advocate surely meant the company that ran the shop had *granted* a floating charge; the shop is not a separate legal personality and the example would not make sense if the seller was the grantee of the charge. One MP in attendance (Bruce Millan) had to later note that some examples provided by the Lord Advocate and Forbes Hendry were possibly misleading as floating charges would only be grantable by companies (col 14).

⁸⁶⁹ *Ibid*, col 8.

⁸⁷⁰ *Ibid*. The use of "his tie" might mean that ownership was held by the purchaser, or it may have just been a more general reference to the property the "purchaser" was seeking to buy.

⁸⁷¹ 1893 Act, ss 39(1) and 41. Now, the 1979 Act, ss 39(1) and 41.

If ownership had already passed the property would not be part of the seller's estate available to a liquidator. Given the apparent opacity, it would be inappropriate to present firm conclusions as to what the Lord Advocate actually meant.⁸⁷²

(2) *Sharp v Thomson*

Sharp casts some doubt upon the applicability of the full ownership attachment approach to corporeal moveables. As regards the extent of the ratio, the SLC, in their *Sharp Report*, presume that it applies to non-heritable property.⁸⁷³ If *Sharp* applies, it may be that ownership by the chargor is necessary for a charge's attachment but that there are additional requirements. On a more extreme (and problematic) view, ownership by the chargor is *not* necessary for attachment.

There has, however, been relatively little analysis of the implications of the decision for corporeal moveable property.⁸⁷⁴ Birrell states that *Sharp* might mean that where goods are sold and delivered, but title is retained until payment, the "beneficial interest" is held by the purchaser not the seller.⁸⁷⁵ The seller can only recover the goods if the purchaser does not pay the price and the purchaser will have the express or implied right to use the property. However, he thinks it is more likely that "beneficial interest" remains with the seller until the fulfilment of the relevant suspensive condition, whether that is payment or another obligation.⁸⁷⁶ Birrell justifies this by referring to the "anomalies" that would otherwise be created, as well as because the seller has "taken a positive step to retain his entitlement" to the property under the sale contract. He also contends that goods differ from other property as they can be recovered "without the intervention of the court in the form of a decree of reduction".⁸⁷⁷ The meaning of the final point is unclear, as a court order for repossessing goods is required under Scots law for valid dispossession (unless there is consent),⁸⁷⁸ and there is no obvious reason why this should be treated differently from a decree of reduction in the context. The other points are

⁸⁷² The absence of a clear statement by the promoter of the legislation would also preclude the use of the comments in court under the rule deriving from *Pepper* (n 15).

⁸⁷³ SLC, *Sharp Report*, para 2.6.

⁸⁷⁴ But see eg *Greene and Fletcher: Receivership*, para 2.06, where it is suggested that the case applies to moveable property too.

⁸⁷⁵ Birrell (n 726) at 153.

⁸⁷⁶ Ibid.

⁸⁷⁷ Ibid.

⁸⁷⁸ See eg Reid, *Property*, para 5.

more powerful ones. As has been pointed out elsewhere, a range of difficulties arise from *Sharp*, including for corporeal moveables, as mentioned by Lord Hope in the Inner House.⁸⁷⁹

It can be argued that the ratio from *Sharp* is not applicable to corporeal moveables, on the basis that it represents a special exception for heritable property,⁸⁸⁰ or for property which is transferred in a form that more closely resembles the transfer process for heritable property. The sale of heritable property is (usually) a three-stage process of contract, delivery of the disposition and registration. For the sale of corporeal moveables at common law there is (normally) a two-stage process of contract and delivery. And under the 1979 Act, ownership will often pass upon conclusion of contract, but the parties could instead agree that ownership passes upon the fulfilment of one or more of a multitude of possible conditions.⁸⁸¹ The absence of a compulsory formal step equivalent to delivery of a disposition for sale of goods, and the burdensome consequences of examining the particular circumstances of every case, are also arguments against applying *Sharp* to this type of property. For the transfer of corporeal moveables generally, there is not even a corresponding stage to delivery of a disposition. The delivery of corporeal moveables, unlike delivery of a disposition, ordinarily either transfers ownership (at common law)⁸⁸² or post-dates the transfer of ownership (under the 1979 Act). It should be noted too that Lord Clyde in *Sharp* proceeded on the basis that there would be no implications for moveable property arising from the decision.⁸⁸³ Furthermore, the 1979 Act's reference to the transferring of "property" in goods from the seller to the buyer should be interpreted consistently with property leaving the "property and undertaking" of the selling chargor. This would mean that, for sales of goods, transfer of ownership from the chargor to another equates with property no longer being attachable by a seller-granted charge.

Yet even if *Sharp* does extend to corporeal moveables, the implications appear minimal if delivery of the disposition is the key stage for heritable property. Assuming that delivery of property could be deemed the equivalent of delivery of a disposition, there will usually be simultaneity at common law between the property leaving the property and undertaking and

⁸⁷⁹ N 742.

⁸⁸⁰ Rather than demonstrating the general rule for all property. St Clair and Drummond Young, *Corporate Insolvency*, paras 6-10f, suggest that "beneficial ownership" is necessary for attachment to heritable property but in the same context refer only to moveable property "owned" by a company.

⁸⁸¹ See eg Guild (n 740) at 275.

⁸⁸² And therefore more closely corresponds to the registration of heritable property. The delivery of corporeal moveables can also not be equated with the giving of possession of heritable property.

⁸⁸³ At 85.

ownership being transferred.⁸⁸⁴ And under the 1979 Act ownership will often pass even before delivery takes place, which apparently means that the property has already left the company's property and undertaking. In addition, if delivery of a disposition is important as an objective indicator that the seller wishes to, or must, transfer ownership, and because the purchaser then has the power to obtain ownership by the final obligatory step of registration, the position is not the same for corporeal moveables. The parties can decide precisely when ownership transfers and may agree that it will not transfer until after delivery. If so, this reflects an intention for "beneficial interest" not to pass until fulfilment of the relevant conditions, as suggested by Birrell above.⁸⁸⁵ Until ownership passes to the transferee, it cannot be said that the transferor has no interest in the property, as this directly contradicts what the parties have agreed.

(3) The Wilson Analysis

Professor Wilson states that "[g]oods which have been sold but were still in the company's ownership and possession at the date of attachment are subject to the security of the holder of the floating charge even if the price has been paid".⁸⁸⁶ In his view, the property would seemingly be attachable by B Bank's charge if A Ltd had retained ownership *and* possession when attachment occurred.⁸⁸⁷ But what is meant by "possession" here? Wilson surely does not mean that in every case where A Ltd loses natural possession, but retains civil possession, B Bank's charge will not attach. If this were so, it would often exclude a large volume of goods belonging to a chargor, such as where that property is being transported or stored by another. But Wilson does seem to consider that the loss of natural possession by A Ltd during the course of a sale transaction, even a conditional sale or hire-purchase, means B Bank's charge cannot attach.⁸⁸⁸ Separately, it is not obvious whether Wilson considers it necessary for *C Ltd* to have ownership *and* possession before D Bank's charge could attach. It is certainly difficult

⁸⁸⁴ It is equivalent in effect to registration of the disposition of heritable property.

⁸⁸⁵ Cf the uncertainty expressed by *Guild* (n 740) at 275f, as to when "beneficial interest" will be considered to have passed in retention of title scenarios.

⁸⁸⁶ Wilson, *Debt*, para 9.18. This was, of course, written prior to *Sharp*.

⁸⁸⁷ This is supported by his further comments; these are outlined in the retention of title section below.

⁸⁸⁸ For the meaning of possession see eg Reid, *Property*, paras 119ff; and Anderson, *Possession*, paras 1-09ff. The notion that Wilson is excluding civil possession is supported by his subsequent suggestion (also at para 9-18) that a floating charge will not attach where a hire-purchaser has acquired possession. There is no mention that the party retaining ownership would possess civilly through the hire-purchaser.

to justify requiring both of these elements for the attachment of B Bank's charge but not for the attachment of D Bank's charge.

Assuming that Wilson considers ownership and natural possession to be necessary conditions for a charge to attach within a sale context, the difference between his position and the full ownership attachment approach applies only where: (i) A Ltd retains ownership but C Ltd has obtained natural possession; or (ii) ownership has transferred to C Ltd but natural possession remains with A Ltd. Yet why should such possession determine whether or not a floating charge can attach? The floating charge is a security right that is not dependent upon the chargeholder possessing, naturally or civilly. It would seem strange to require the *chargor* to possess, like a proxy for the chargeholder, in certain situations (but not others) to enable a charge to attach.

Even limiting a natural possession requirement to the context of sale has significant consequences in many commercial situations.⁸⁸⁹ For instance, unless retention of title arrangements were an exception, a charge created (earlier or later) by the continuing owner could not attach to property dealt with in this way. Given that the chargor expressly retains ownership, and this right is what would be attached by the charge, to provide that there would be no attachment by the owner-granted charge seems counter-intuitive. It would also raise questions as to when the charge could attach to the property again, if the ownership transfer conditions remained unfulfilled.

A further implication is that, despite the apparent universality of floating charges, there could be points during transactions where neither B Bank nor D Bank's charges could attach to property that A Ltd was transferring to C Ltd. This would occur where natural possession and ownership were split between the two parties. Attachment to personal rights would be possible, and could bridge the attachment divide, but this would not assist if the obliged party became insolvent. In addition, to have an approach that is at odds with the insolvency processes, in which the charge is enforced, is undesirable. In such processes, the debtor's ownership determines if property falls into the insolvent estate.⁸⁹⁰

⁸⁸⁹ It certainly does not apply where other secured creditors have natural possession. For example, a pledgee has natural possession yet a floating charge attaches to the ownership of pledged property and ranks against the pledgee's right.

⁸⁹⁰ For the relationship between ownership and insolvency for corporeal moveables, see eg DL Carey Miller et al, "National Report on the Transfer of Movables in Scotland" in *National Reports*, vol 2, para 7.2 and ch 9. At para 9.4.1 it is also stated that where a transferor retains ownership he can

Wilson does not fully explain his reasoning and it is therefore difficult to know exactly what he means. The issue of continued or lost possession is important in contexts such as whether the buyer or seller can sell the property to another party,⁸⁹¹ however, it is not clear why possession should be decisive for attachment. Due to the inherent uncertainty in Wilson's approach,⁸⁹² and the further problems outlined above, it should not be considered to represent the law.

C. ATTACHMENT AND SECURITY RIGHTS

(1) Pledge

Attachment of the floating charge is relatively straightforward where charged corporeal moveable property is encumbered by one or more subordinate real rights in security.⁸⁹³ This is true whether such securities are created before or after the charge. The property (ie the ownership of the object) remains in the chargor's patrimony and is attachable. Ranking rules determine whether the floating charge or a subordinate real right in security (fixed security) has priority.⁸⁹⁴ There are voluntary non-possessory real security rights in Scots law: eg bonds of bottomry and respondentia at common law, and aircraft and ship mortgages. However, these are limited to particular sub-types of corporeal moveable property and are exceptions to the general rule that delivery and possession are required to constitute real security over corporeal moveables.

Pledge is the recognised form of voluntary security for corporeal moveables generally. It requires the delivery of the property to the pledgee and for that party to remain in possession.⁸⁹⁵

vindicate his right of ownership despite the transferee's insolvency. Possession does, however, give a rebuttable presumption that the possessor owns the property: see Carey Miller, *Corporeal Moveables*, para 1.19 and the sources cited there.

⁸⁹¹ See 223f. And see Consumer Rights Act 2015, s 29, which makes the passing of risk dependent upon possession in consumer sales.

⁸⁹² Additional comments by Wilson also cast doubt upon what he means: see 225f below.

⁸⁹³ These are rights in security in the strict, or narrow, sense identified by Gretton, "Concept of Security".

⁸⁹⁴ 1985 Act, s 464.

⁸⁹⁵ As to the requisite forms of delivery and possession, see Steven, *Pledge*, paras 6-07ff. We do not need to give consideration here as to what is required to create a valid pledge. References to pledge assume the pledge is validly constituted.

Pledge is a subordinate real right in security and the pledgor retains ownership.⁸⁹⁶ As a result, the pledgor continues to hold an attachable interest in the property and that property stays within the pledgor's property and undertaking.

For corporeal moveable property, the prevailing interpretation of the attachment mechanism is that the floating charge attaches as if it were a pledge.⁸⁹⁷ As Professor Wilson notes, this is so even though the creditor does not possess the property.⁸⁹⁸ The consequence is that there are two subordinate real rights of pledge in competition with one another. Given that possession by the pledgee is necessary at common law, attachment of a charge can lead to the unprecedented situation of multiple pledges in competition.⁸⁹⁹ The competition is resolved by the statutory ranking rules; however, if the charge has priority (due to earlier creation with a negative pledge) the effect of a deemed pledge will not extend to the chargeholder being considered to have possession at the expense of the pledgee. As a result, the prevailing statutory hypothesis adds little here. The alternative *sui generis* approach would simply involve a pledge in competition with a generic security over the property, the ranking provisions for which are outlined by the legislation.

(2) Transfer of Ownership as Security

(a) Method of Transfer

Under the 1979 Act, ownership may be transferred at an agreed point without delivery.⁹⁰⁰ However, the provisions of the 1979 Act regarding contracts of sale “do not apply to a transaction in the form of a contract of sale which is intended to operate by way of mortgage, pledge, charge, or other security.”⁹⁰¹ In other words, the Act is disapplied in favour of the common law where a sale contract is used for a security transaction. At common law a party may transfer property *ex facie* absolutely to a creditor where the intention is to create a security

⁸⁹⁶ See eg Steven, *Pledge*, paras 2-01 and 7-01ff.

⁸⁹⁷ See chapter 5. And see the discussion below regarding the transfer of ownership as security.

⁸⁹⁸ Wilson, *Debt*, para 9.18.

⁸⁹⁹ See Steven, *Pledge*, paras 6-52ff.

⁹⁰⁰ This and the following points were also true of the 1893 Act.

⁹⁰¹ 1979 Act, s 62(4).

right, in the wide sense, in the creditor's favour.⁹⁰² However, the law requires delivery to transfer ownership or to create a real security right.⁹⁰³

Due to the formality of the common law requirements, attempts have long been made to utilise the statutory provisions on sale to create a functional security, notwithstanding the contents of s 62(4) (and previously s 61(4) of the 1893 Act).⁹⁰⁴ Many such attempts have been unsuccessful.⁹⁰⁵ This has included a number of cases in which sales followed by immediate hiring back to the seller, without delivery, have been held invalid. The circumstances in which the legislative transfer provisions do not, and ought not to, apply to transfers in security have been discussed by others.⁹⁰⁶ The debate cannot be recapitulated here; we are simply concerned with the consequences where there are effective transfers for the purposes of security (by delivery under the common law or, if possible, through the 1979 Act transfer provisions). This matter does, however, raise some larger questions as to what Scots law should consider pivotal when deciding the categorisation and effect of a transaction: eg the parties' intention, their motivations, the transaction's form or its substance.

(b) Attachment of Property Transferred in Security

The classic definition of "right in security" in Scots law is wide and inclusive in its scope and extends beyond subordinate real rights in security.⁹⁰⁷ It incorporates functional securities, such as the transfer of ownership for security purposes.⁹⁰⁸

⁹⁰² See eg *Hamilton v Western Bank* (n 802). And see Bell, *Commentaries*, II, 11. The transfer of ownership may be more favourable to the creditor than pledge as it provides more extensive automatic powers and rights to the creditor, including the conferral of all sums security.

⁹⁰³ See eg *Clark v West Calder Oil Co* (1882) 9 R 1017.

⁹⁰⁴ See Carey Miller, *Corporeal Moveables*, para 11.13f; and Wilson, *Debt*, para 7.3.

⁹⁰⁵ Eg *Robertson v Hall's Tr* (1896) 24 R 120; *Jones & Co's Tr v Allan* (1901) 4 F 374; *Rennet v Mathieson* (1903) 5 F 591; *Hepburn v Law* 1914 SC 918; *Newbigging v Ritchie's Tr* 1930 SC 273; *Scottish Transit Trust v Scottish Land Cultivators* 1955 SC 254; *G&C Finance Corp Ltd v Brown* 1961 SLT 408.

⁹⁰⁶ See Stewart, *Diligence*, 150f; Gretton, "Concept of Security", 132ff; S Styles, "Debtor-to-Creditor Sales and the Sale of Goods Act 1979" 1995 JR 365; Carey Miller, *Corporeal Moveables*, paras 11.14ff; Wilson, *Debt*, para 7.3, suggests that "a genuine *pactum de retrovendendo* is not struck at" – see *Gavin's Tr v Fraser* 1920 SC 674.

⁹⁰⁷ Gloag and Irvine, *Security*, 1f. See also WM Gloag, "Securities" in *Encyclopaedia of the Laws of Scotland*, vol 13 (1932), paras 778ff. At eg para 782f, it seems that Gloag identifies less of a distinction between ownership and subordinate real rights than is the case today (with more focus on form and function than concepts). (There is a very similar entry by Gloag, also entitled "Securities" in the earlier *Green's Encyclopaedia of the Law of Scotland*, vol 11 (1899) and 2nd edn, vol 10 (1913).)

⁹⁰⁸ See Gretton, "Concept of Security"; Wilson, *Debt*, para 7.1, notes various meanings of the term "security". For a statutory definition of "security" see eg 1986 Act, s 248(b)(ii) which refers to "any

(i) **The Attachment Problem**

With this type of “security”, the creditor obtains ownership from the debtor while the debtor has a personal right against the creditor for ownership to be re-transferred upon satisfaction of the sums due.⁹⁰⁹

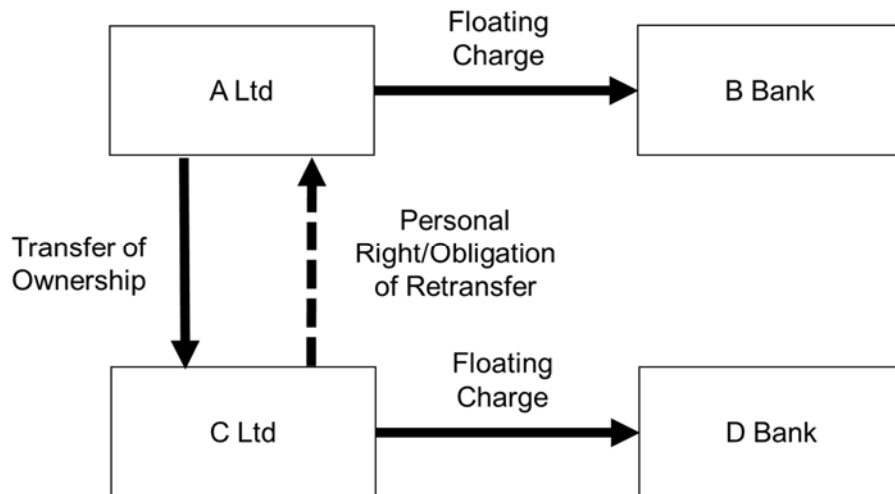

Of course, the transfer of ownership would ordinarily mean that B Bank’s charge would not be able to attach to the property after it is transferred by A Ltd to C Ltd. It could only attach to the personal right of retransfer. By contrast, D Bank’s charge may attach to the property while it is owned by C Ltd. There is, however, a conflict within the floating charges legislation between property being transferred, which removes it from the company’s property and undertaking, and the recognition of functional securities as “fixed securities”, which the charge can rank ahead of. But while *ex facie* absolute dispositions and assignments in security were expressly included as fixed securities under the 1961 Act, and assignment in security has been recognised as a fixed security in *Forth & Clyde*, does the term also encompass the transfer of ownership of corporeal moveables in security?

security (whether heritable or moveable), any floating charge and any right of lien or preference and any right of retention (other than a right of compensation or set off)”.

⁹⁰⁹ See eg *Hamilton v Western Bank* (n 802) per Lord Deas at 166.

(ii) **A Fixed Security?**

The general part of the definition is as follows: “‘fixed security’, in relation to any property of a company, means any security, other than a floating charge or a charge having the nature of a floating charge, which on the winding up of the company in Scotland would be treated as an effective security over that property...”.⁹¹⁰ The term is limited to securities relating to property, and thus excludes cautionary obligations. Given that a qualifying security requires to be effective over the property in a liquidation, this excludes personal rights generally. The definition does, however, seem predicated on any property being “property of [the] company”. Strangely then, although the property will be the company’s before ownership is transferred for security purposes, the effect of such a “security” means it is no longer the company’s property. This result also raises further doubts as to whether the charge could attach to this property; the charge attaches as if it were a fixed security, but a fixed security’s meaning depends upon the property being the company’s. It is true that the transfer to C Ltd would broadly constitute an “effective security” in A Ltd’s winding up; but it is an effective security *because* it is not actually subject to the winding up.⁹¹¹

The problem will usually not be so apparent where the charge ranks behind the functional security. Even if B Bank’s charge cannot attach to the property, C Ltd will be compelled to retransfer the property or hand over surplus proceeds to A Ltd if the debt due is satisfied. This will enable B Bank to claim its priority status via a liquidator, receiver or administrator of A Ltd. There would, however, be a problem if C Ltd became insolvent. A Ltd would ordinarily only have a personal right against C Ltd, which would not enable B Bank’s charge to have a ranking priority over creditors of C Ltd, including D Bank. It is even more problematic where B Bank’s charge ranks ahead of C Ltd’s “fixed security”. Without attachment to the property, it is not obvious how this relative ranking could be given effect to, whether or not C Ltd became insolvent. A further difficulty with C Ltd owning the property is that it has the power to sell and transfer the property to another, and it seems even more doubtful that B Bank’s charge could be enforced against that transferee or its singular successors.⁹¹²

⁹¹⁰ See 1985 Act, s 486(1), and 1986 Act, s 70(1).

⁹¹¹ In German legal terminology, this would be an *Aussonderungsrecht*. See 245ff and 258ff for more details.

⁹¹² Especially since these parties are not being granted “fixed securities” by the *chargor*.

Professor Gow, writing a few years after the charge's introduction, recognises some of the difficulties involving the relationship between the floating charge and transfer of corporeal moveables for security purposes. After correctly noting that pledging a truck after the grant and registration of a floating charge, with negative pledge, would mean the charge would rank ahead, he queries what the position would be if the company instead sold the truck to a buyer who then hired it back to the company (with the company having a re-purchase option).⁹¹³ This type of "sale and leaseback" transaction is a relatively common form of functional security over corporeal moveables. Gow states that if the sale is *bona fide* then ownership would be conveyed to the buyer.⁹¹⁴ Consequently, he asks whether the buyer would be "compelled to cede" the truck (if not already sold to another party) if the company entered winding up.

Gow suggests that if the legislation (in his case the 1961 Act) is to be read literally, it seems as if the buyer must give the truck over to the liquidator.⁹¹⁵ He is presumably searching here for a means by which the chargeholder can obtain its ranking priority if the sale and leaseback transaction is recognised as a fixed security. Yet Gow expresses doubt about this particular interpretation. He refers to what was then the definition of fixed security as including a security "created by way of an *ex facie* absolute disposition or assignation qualified by a back letter" and submits that this is "a misunderstanding of what the general law is, at least in respect of corporeal moveables, to which it may be that the definition does not apply".⁹¹⁶ And even if the definition was intended to apply to corporeal moveables, "if there is an absolute conveyance of the *dominium* the creditor has a security in the popular sense that he need not yield the property to the general creditor, but his right is as owner, and not as a charge or burden on the *dominium* of the debtor".⁹¹⁷

The terms "disposition" and "assignation" in the definition of "fixed security" in the 1961 Act should be read in the narrow technical sense applicable to heritable and incorporeal property

⁹¹³ Gow, *Mercantile Law*, 282. The transaction would likely fall within the ambit of s 62(4) of the 1979 Act (and formerly s 61(4) of the 1893 Act) and thereby require delivery to transfer title. In practice, artificial and transient means are used to fulfil the delivery requirement, see J Hamilton et al, *Business Finance and Security over Moveable Property* (Scottish Executive Central Research Unit) (2002), paras 3.130f. This form of delivery may not be sufficient. For discussion of what is required for valid delivery, see eg Anderson, *Possession*, paras 5-06ff.

⁹¹⁴ Gow, *Mercantile Law*, 282.

⁹¹⁵ *Ibid.*

⁹¹⁶ *Ibid.*

⁹¹⁷ *Ibid.*

rather than in a wider sense also encompassing corporeal moveable property.⁹¹⁸ But there is still the possibility that the general part of the meaning of fixed security, in past and present legislation, extends to the transfer of ownership of corporeal moveables for security purposes, especially since it has been so accepted for the assignation in security of incorporeal moveables. Gow, however, seems to recognise difficulties in a floating charge defeating a competing “security” right if the property does not belong to the chargor. This stems from the apparent absence of attachment and is a potentially insurmountable problem for functional security rights where ownership is transferred. B Bank’s floating charge will, however, attach to any sums received in return for the property, as well as to personal rights of retransfer held by A Ltd and any subordinate real rights A Ltd acquires in the property.⁹¹⁹

The ratio from *Sharp* is also of no assistance in enabling B Bank’s charge to attach to transferred property, unless a full equitable approach is adopted. (A limited ownership attachment approach would require A Ltd to own the property as well as having eg “beneficial interest”.) The numerous problems with such a full equitable approach include the questions of what precisely is attached (if not ownership) and how enforcement would take place if the property is beyond the scope of the enforcement mechanisms of liquidation or equivalent.

As implied above, the definition of “fixed security” (past and present) should not be deemed to extend to the transfer of ownership of corporeal moveables as security or to functional securities generally. Even if functional securities are recognised as fixed securities, a charge granted by the transferor could seemingly not attach and, if it could, there is no identifiable means of enforcement against such property. It may be that functional securities over corporeal moveables are not fixed securities due to the existence of the subordinate real right of pledge, which is generally applicable. This could enable corporeal moveables to be distinguished from other property, for which there is no subordinate real right in security. But this seems an arbitrary solution to determine the meaning of fixed security, even if it reaches the appropriate result for corporeal moveables. It also fails to tackle some of the inherent difficulties with such an approach, particularly for incorporeal property.

⁹¹⁸ McBryde, *Contract*, para 12-20, notes within earlier sources a “perplexing tendency to refer to assignation of corporeal moveables.” See also eg Goudy, *Bankruptcy*, 551, who contrasts the proprietary effect of pledge with the “assignation” of moveables in security; and Stewart, *Diligence*, 151, 154 and 157, who refers to the “assignation” of corporeal moveables.

⁹¹⁹ If the position regarding (non-)attachment to the transferred property were otherwise then the floating charge could apparently attach to: (i) the property; (ii) the money received for the property; (iii) any personal right the company has for the return of the property; and (iv) any rights created in the property, such as lien. This does not seem right.

(3) Retention of Title

(a) General

The previous section examined the transfer of ownership as security. By contrast, this section deals with another functional security, the *retention* (reservation) of title (ownership) of corporeal moveable property by a seller. It is often used to secure payment of the price for a sale or to secure all sums due by a buyer to a seller. The validity of retention of title is long-established at common law in Scotland and is also allowed by the 1979 Act.⁹²⁰ In *Armour v Thyssen Edelstahlwerke AG*⁹²¹ it was held that retention of title for all sums due by the debtor to the creditor is valid.

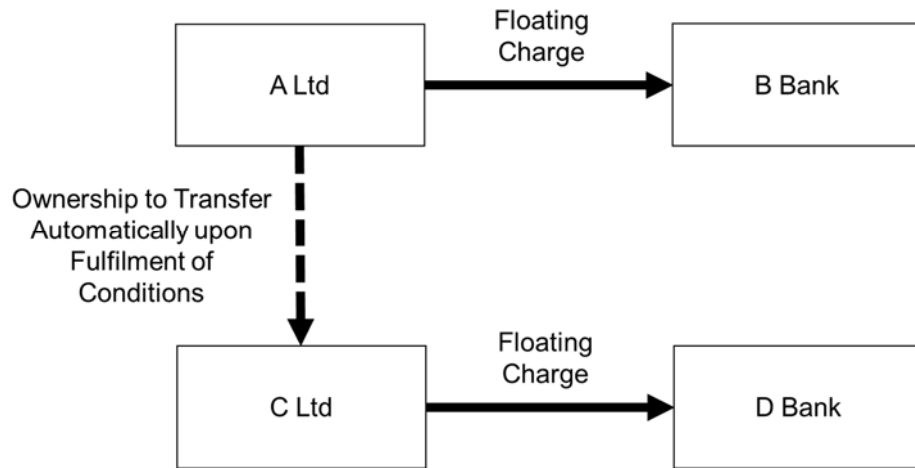

In the scenario represented in the diagram above, A Ltd is using its ownership of goods to secure the fulfilment of C Ltd's obligations. As A Ltd retains ownership, C Ltd will not have title to transfer to others. By retaining title, A Ltd also protects itself in the event of C Ltd's

⁹²⁰ See Stair, I, 14, 4; Carey Miller, *Corporeal Moveables*, para 12.02ff; DL Carey Miller et al, "National Report on the Transfer of Movables in Scotland" in *National Reports*, vol 2, paras 15.2ff. As regards the 1979 Act, see ss 17ff, especially s 19(1). Problems regarding retention of title and s 62(4) of the 1979 Act might arise but in the case of *Armour* (see below) the applicability of this was rejected in the circumstances of the case.

⁹²¹ 1990 SLT 891, HL.

insolvency.⁹²² Rather than simply being an unsecured creditor, A Ltd would have the ultimate priority, as the property would not form part of C Ltd's insolvent estate.

If A Ltd reserves title when selling property to C Ltd then B Bank's charge can apparently attach to the property, as well as to A Ltd's personal rights against C Ltd. D Bank's charge can attach to C Ltd's right to obtain ownership, which is conditional upon fulfilment of the agreed conditions.⁹²³ It seems that where title is retained this will limit the corporeal moveable property secured by D Bank's charge.⁹²⁴ Once the conditions are satisfied, however, the property will automatically transfer to C Ltd (unless in the meantime A Ltd has sold the property to another). Upon A Ltd losing ownership, B Bank's charge can no longer attach to the property, but the transfer to C Ltd will enable D Bank's charge to do so. As stated above, even if *Sharp* applies to corporeal moveables, it is surely not the case that A Ltd would retain no "beneficial interest": the parties' agreement indicates that A Ltd wishes to preserve an interest in the property.

It should be noted that, despite A Ltd's retention of title, if C Ltd is in possession of the goods it can transfer them by sale (or pledge them) to a good faith acquirer (or pledgee) who does not have notice of A Ltd's right in the property. Such a transaction has effect as if C Ltd was possessing the property as A Ltd's mercantile agent.⁹²⁵ B Bank's charge could therefore no longer attach to the property, but could attach to any claim held by A Ltd against C Ltd.

⁹²² See eg McKenzie Skene, *Insolvency*, 160. For an illustration of this, see S Wheeler, *Reservation of Title Clauses: Impact and Implications* (1991), 19.

⁹²³ D Bank's charge could also attach to any other personal rights C Ltd had against A Ltd.

⁹²⁴ Indeed, it has been stated that: "the comprehensive nature of the floating charge... caused suppliers of goods to resort increasingly to a clause of reservation of title": Jack (n 8), 42. And see Wheeler, *Reservation of Title* (n 922), 19. At 37, Wheeler notes that parties reserving title under English law sometimes create a floating charge accidentally, which is rendered ineffective by the lack of registration. L Gullifer, "'Sales' on Retention of Title Terms: is the English Law Analysis Broken?" (2017) 133 LQR 245 at 264ff, has also suggested that if a retention of title clause is viewed functionally, it can be recharacterised as a floating charge in English law. In Scots law there is no fall-back common law floating charge and retention of title cannot be recharacterised as such a charge.

⁹²⁵ 1979 Act, s 25(1). There is an equivalent where ownership has transferred but the seller remains in possession (s 24). For discussion of these sections, see Reid, *Property* (Gamble) paras 681f. S 25 does not apply to buyers under "conditional sale agreement[s]" (s 25(2)), which, in this context, are limited to consumer credit agreements in terms of the Consumer Credit Act 1974. See also Hire-Purchase Act 1964, s 27(3).

(b) Exceptions?

Contrary to the above, Professor Wilson suggests that (at least) some retention of title transactions cause B Bank's charge to become unattachable to the relevant property:

Goods which are on conditional sale or hire-purchase and which were still in the company's property but which are in the possession of the acquirer are not, it is thought, affected by the attachment of the charge. The floating charge creditor should not be in this respect in a better position than a liquidator; the acquirer has a right of retention over the goods which, being a security arising by operation of law, prevails over the floating charge.⁹²⁶

There are contradictory comments here: Wilson implies that the floating charge does not attach, yet argues that the "acquirer's" right ranks ahead of the floating charge, which presupposes attachment. And why should a chargeholder not be in a better position than a liquidator? It is true that a chargeholder relies upon a liquidator (or equivalent) to enforce the charge but the attachment effect gives the chargeholder a stronger priority right than the liquidator and unsecured creditors. Nevertheless, Wilson raises an interesting wider question; how could a liquidator or equivalent obtain control of property in the possession of a party such as a hire-purchaser⁹²⁷ to enable realisation and distribution to a chargeholder?

A liquidator (or receiver or administrator) would have the ability to sell the property, even if it was possessed by a third party, but that party's possession might limit the property's value. As regards possession, a liquidator is under a duty to "take into his custody or under his control" all of the property "to which the company is or appears to be entitled".⁹²⁸ Also, the court may require any person who has in his possession or control any property "to which the company appears to be entitled" to deliver that property to the liquidator.⁹²⁹ It is not wholly clear whether "entitled" excludes property that another party has a valid right to possess, such as a hire-purchaser. But if this were the case, it would be contrary to the general ambit of liquidation, which enables the liquidator to control and realise all of the company's property, subject only to real rights. It must therefore be dismissed. In addition, a hire-purchaser's possession depends upon a contractual agreement with the owner. Yet, as Wilson notes, the

⁹²⁶ Wilson, *Debt*, para 9.18.

⁹²⁷ For a highly critical view of hire-purchase in Scots law, see Gow, *Mercantile Law*, 249ff.

⁹²⁸ 1986 Act, s 144(1). See also 1986 Rules, r 4.22(1)(a).

⁹²⁹ 1986 Act, s 234(2). See also s 237.

liquidator is able to adopt or abandon contracts made by the company.⁹³⁰ If abandonment takes place, the other party can claim damages for breach as an ordinary creditor in the liquidation.⁹³¹ This remedy would also apply to a hire-purchaser dispossessed by a liquidator following abandonment of a hire-purchase contract. In addition, there may be particular contractual provisions which would allow the company, and potentially the liquidator (or equivalent), on the company's behalf, to terminate the hire-purchase or conditional sale contract.⁹³²

In case of any doubt regarding his powers in relation to the property, the liquidator could also apply to the court to have all or any part of the company's property vested in him.⁹³³ If he did so, he could use proprietary remedies to recover the property, and the hire-purchaser's rights against the company would be of minimal value. The vesting of the property in the liquidator would also stop the hire-purchaser from subsequently acquiring ownership.

A receiver, meanwhile, has the express power to "take possession of, collect and get in the property from the company or a liquidator thereof or any other person, and for that purpose, to take such proceedings as may seem to him expedient", which would seemingly permit him to obtain possession from the hire-purchaser.⁹³⁴ There is an almost identical provision for administration.⁹³⁵ And a court can also order other parties to transfer possession to the administrator or receiver.⁹³⁶ Of course, the practical problems and cost involved in recovering possession, in comparison to the value of the property, may dissuade a liquidator, receiver or administrator from doing so, or it might cause such a party to seek a compromise with a hire-purchaser.⁹³⁷ A party non-consensually dispossessed by a liquidator, receiver or administrator

⁹³⁰ See n 520. See also RG Anderson, "Corporate Insolvency and Dissolution" in IG MacNeil (ed), *Scots Commercial Law* (2014), paras 14.72ff, who notes that adoption only applies to liabilities. "Abandonment" could be more accurately termed non-adoption, as the liabilities still remain with the company; they are simply not adopted by the liquidator.

⁹³¹ See *Asphaltic Limestone Concrete Co Ltd v Glasgow Corp* 1907 SC 463; *Clyde Marine Insurance Co v Renwick* 1924 SC 113; *Highland Engineering* (n 930); McKenzie Skene, "Corporate Insolvency", para 306.

⁹³² Where the Consumer Credit Act 1974, s 98, applies, the creditor or owner must give not less than seven days' notice of termination to the debtor or hirer, where the latter are not in default. There is also a statutory provision which allows the court to rescind contracts between the company and another party on such terms as it thinks fit, but this is only available upon the application of that other party: 1986 Act, s 186(1).

⁹³³ 1986 Act, s 145(1).

⁹³⁴ *Ibid*, Sch 2, para 1. See also *Palmer's Company Law*, (n 191), para 14.215.1.

⁹³⁵ *Ibid*, Sch 1, para 1.

⁹³⁶ *Ibid*, s 234(1) and (2).

⁹³⁷ Liquidators have powers to compromise – 1986 Act, Sch 4, para 2 and 3(b); as do administrators – Sch 1, para 18; and receivers – Sch 2, para 16.

would almost certainly gain a breach of contract claim but would only be an unsecured creditor in the insolvency of the party from whom they obtained the property.

Wilson himself writes that the ownership of a hire-purchase item does not transfer to the hire-purchaser until final payment is made.⁹³⁸ And this means the property would not pass to that party's trustee in sequestration, if sequestration occurred at an earlier point.⁹³⁹ By extension, such property would also not fall within a corporate hire-purchaser's liquidation, receivership or administration.⁹⁴⁰ If the property is not considered part of C Ltd's estate or property, upon insolvency, but would, instead, fall within A Ltd's estate, it seems illogical for it not to be attachable by B Bank's charge.

Another issue to consider is what the outcome would be if the relevant condition for transfer of a corporeal moveable is satisfied after the attachment of the charge. For example, C Ltd makes the final payment necessary for transfer *following* the commencement of A Ltd's liquidation, receivership or administration, and after B Bank's charge has attached. Wilson suggests that a trustee in sequestration cannot prevent a hire-purchaser obtaining ownership of the goods, and this is also Gow's position.⁹⁴¹ This would apply *a priori* to a liquidator, receiver or administrator due to the absence of automatic vesting in those parties. Although the chargeholder would have been deemed to hold a fixed security over the property, the valid transfer of that property would seemingly render the charge unenforceable against it. The same would apparently apply where a possessor obtains ownership by original acquisition, such as accession;⁹⁴² however, this may give rise to a breach of contract claim against that possessor.

Fundamentally, a hire-purchaser or other party seeking special protection in the liquidation, receivership or administration of the owner of property must have a basis beyond possession and personal rights. This could be by virtue of the acquisition of ownership, or by a subordinate real right. As regards the latter, perhaps Wilson's reference to a conditional purchaser or hire-purchaser having a "right of retention" (see above) refers to a real right of

⁹³⁸ Wilson, *Debt*, para 2.6.

⁹³⁹ *McLaren's Tr v Argylls Ltd* 1915 2 SLT 241.

⁹⁴⁰ However, see below for special rules relating to administration.

⁹⁴¹ Wilson, *Debt*, para 21.7; JJ Gow, *The Law of Hire-Purchase in Scotland*, 2nd edn (1968), 223.

⁹⁴² See eg RB Wood, "Leasing and Hire of Moveables" in *SME*, Reissue (2001), para 81, who notes that leased property will not usually be attached by a floating charge, but will be if it is affixed to heritable property covered by the charge.

lien.⁹⁴³ Indeed, he writes elsewhere that: “A right of retention or special lien arises wherever property comes into the possession of someone other than the proprietor under a contract which creates rights *hinc inde*.”⁹⁴⁴ Wilson states that this right is based upon mutuality of obligations.

As will be seen below, a lien would constitute a fixed security arising by operation law, whereas a contractual right of retention would not, and “retention” based on ownership is not possible as the hire-purchaser is not owner. A lien can seemingly be acquired over property on hire-purchase, if the owner gives authority for the hire-purchaser to, for example, have repairs carried out and thereby subject the property to a lien.⁹⁴⁵ However, this lien would be a right held by the repairing third party and it is difficult to see how the *hire-purchaser* can acquire a lien by virtue of the hire-purchase contract alone. Unlike a lienholder, the hire-purchaser can use the property. And, more significantly, what are the mutual obligations upon which a lien right would be based? This is a major obstacle, but, as Dr Steven notes, there are cases in which a special lien for damages has been accepted.⁹⁴⁶ Such an outcome could have relevance to a hire-purchase situation; however, a claim for damages due to dispossession may only arise after such an event, in which case the lien will have been lost. Yet perhaps a damages claim may result from *any* interference with a hire-purchaser’s “quiet possession”,⁹⁴⁷ even if this occurs prior to formal dispossession. If so, a hire-purchaser would have a special lien, and ranking rules would determine the lien’s priority position against an attached floating charge.

⁹⁴³ See eg Sim, “Rights in Security”, para 66, where it is noted, with reference to “retention” and “lien” that “[a] distinction in meaning between the two terms is not always maintained”. As Steven, *Pledge*, para 14.16, states, retention (in the property sense) and lien can be distinguished as the former consists of the creditor retaining ownership, whereas lien involves a creditor acquiring a subordinate real right based on possession (see also para 9.03). Cf Gloag and Irvine, *Security*, ch 10.

⁹⁴⁴ Wilson, *Debt*, para 7.8. And see: Bell, *Principles*, s 1419; *Moore’s Universal Carving Machine Co Ltd v Austin* (1896) 4 SLT 38, where a right of “implied lien” enabled the defender to maintain possession despite an official receiver (of an English company) suing for delivery; and *Paton’s Trs v Finlayson* 1923 SC 872, where a statutory lien and common law lien enabled creditors to keep possession against the debtor’s trustee in sequestration, until sums due were paid.

⁹⁴⁵ See Steven, *Pledge*, paras 13-37ff. The owner’s authority is apparently necessary. See also Gow, *Hire-Purchase* (n 941), 162ff.

⁹⁴⁶ Steven, *Pledge*, paras 16-20ff.

⁹⁴⁷ There is an implied term in “relevant hire-purchase agreements” (those to which ch 2 of Part 1 of the Consumer Rights Act 2015 does not apply (s 15(1))) that the hire-purchaser “will enjoy quiet possession of the goods...”: Supply of Goods (Implied Terms) Act 1973, s 8(1)(b)(ii). If such a term is breached, the hire-purchaser can claim damages (1973 Act, s 12A(1)(a)).

Possession itself is sometimes referred to as a real right, as it “confers the right not to be dispossessed except by consent or by the order of a court.”⁹⁴⁸ Against this background, the provisions for hire-purchase and conditional sale agreements, whereby a party may not recover goods without a court order if the debtor (who is in breach of the agreement) has paid one-third or more of the price, are of limited significance.⁹⁴⁹ If the statutory requirement was to be contravened, the agreement would be terminated and the debtor released from all liability under it, with an entitlement to recover all sums already paid to the creditor.⁹⁵⁰ But this would apparently mean that the debtor could only claim as an unsecured creditor in the insolvency of the owner. Under certain circumstances, and in return for some benefit, a hire-purchaser might decide to voluntarily give up possession to a liquidator or equivalent without a court order.⁹⁵¹

There are certain contexts in which hire-purchase *is* given special protection, but this requires particular provision. If the hire-purchaser goes into administration, there is a moratorium on taking steps to repossess the goods in the company’s possession, without the consent of the administrator or the court.⁹⁵² There is also provision for an administrator obtaining the court’s consent for disposing of the goods.⁹⁵³ And proceeds received are to be used to discharge sums due under the hire-purchase agreement. In these contexts, “hire-purchase agreement” includes a conditional sale agreement as well as a retention of title agreement.⁹⁵⁴ There are also equivalent provisions where directors propose a voluntary arrangement.⁹⁵⁵ But all of these special rules apply where the hire-purchaser, not the owner, enters into a voluntary arrangement or administration.

⁹⁴⁸ Reid, *Property*, para 5.

⁹⁴⁹ Consumer Credit Act 1974, s 90(1). See also s 92(1), which states that “[e]xcept under an order of the court, the creditor or owner shall not be entitled to enter any premises to take possession of goods subject to a regulated hire-purchase agreement, regulated conditional sale agreement or regulated consumer hire agreement.”

⁹⁵⁰ *Ibid*, s 91.

⁹⁵¹ See *ibid*, s 173(3).

⁹⁵² 1986 Act, Sch B1, para 43(3).

⁹⁵³ *Ibid*, paras 72 and 114.

⁹⁵⁴ *Ibid*, para 111(1). As stated in *ibid*, s 436(1), the terms “conditional sale agreement” and “hire-purchase agreement” have the same meanings as under the Consumer Credit Act 1974.

⁹⁵⁵ See 1986 Act, Sch A1, para 1 (for the definition); para 12(1)(g) (for the moratorium); paras 20ff (for disposal rights).

(4) Tacit Security

Tacit security is a form of security that arises automatically in certain circumstances; it is not voluntarily created by the debtor. Along with voluntary security and judicial security (diligence), it can be considered one of the three main security types in Scots law.⁹⁵⁶ There are a number of examples of such security rights: including all types of lien (statutory and at common law) and the landlord's hypothec. These are principally security rights over corporeal moveable property and it is therefore appropriate to treat them here.⁹⁵⁷ It seems as if each form of tacit security can be characterised as a real right in security.⁹⁵⁸ Therefore ownership remains with the debtor. As a result, B Bank's floating charge can attach to A Ltd's property even if another party has a tacit security over that property. (Alternatively, if A Ltd held the tacit security, B Bank's charge could attach to that security right. The charge would attach as if it were a fixed security, which, according to the prevailing approach, would be an assignation in security, as the property is incorporeal moveable property.)⁹⁵⁹

Tacit securities are fixed securities and arise by operation of law.⁹⁶⁰ Where a floating charge is in competition with a tacit security, the ranking rules specify which security prevails. The 1985 Act, s 464(2), provides that: "Where all or any part of the property of a company is subject both to a floating charge and to a fixed security arising by operation of law, the fixed security has priority over the floating charge." Unlike for voluntary fixed securities, this

⁹⁵⁶ According to one taxonomical structure. Bell, *Commentaries*, II, 10, uses this three-fold classification for security over moveable property but refers to tacit securities as "securities resulting from possession". And see Gretton, "Concept of Security", 140f; cf Gretton and Steven, *PTS*, paras 20-32 and 20-57.

⁹⁵⁷ Yet it also appears possible to have a lien over corporeal heritable property: see Steven, *Pledge*, paras 12-02ff.

⁹⁵⁸ Even if some are not truly real rights in security, they are non-divestive. See chapter 2 for more details on the landlord's hypothec. For discussion as to whether lien is a real right, see Steven, *Pledge*, ch 14.

⁹⁵⁹ Therefore, the right of lien will be deemed to have transferred to the first-ranking chargeholder, even though that party does not hold the possession necessary to constitute a lien. Again, a *sui generis* approach to attachment's effect may be more appropriate in this context. In any event, it is important to note that a floating charge seems to be effective against non-transferable property, such as a lien right (see Steven, *Pledge*, para 14-17 regarding the non-transferability of liens). This is because, in reality, the property remains with the lienholder and a sale of the corporeal moveable that is subject to the lien would be by a party acting as a representative of the lienholder (i.e. a liquidator, receiver or administrator). Proceeds could then be paid to the chargeholder. For further details of the effectiveness of the floating charge against non-transferable property, see 237f below.

⁹⁶⁰ Indeed, the terms "tacit", "legal" and "by operation of law" are interchangeable in this context: see Gretton, "Concept of Security", 141.

default ranking rule cannot be displaced by a negative pledge in a floating charge, as s 464(1) is subject to s 464(2).⁹⁶¹

In *Cumbernauld Development Corporation v Mustone*,⁹⁶² it was held that a landlord's hypothec was not a fixed security.⁹⁶³ The sheriff seemingly adopted the defenders' submission that a landlord's hypothec is "a charge having the nature of a floating charge". The pursuer had already conceded that the hypothec was not a fixed security "converted into a real right" before the receiver's appointment.⁹⁶⁴ This concession and the judgment were clearly wrong, and this was recognised in *Grampian Regional Council v Drill Stem*.⁹⁶⁵ The sheriff cited a number of writers who considered a landlord's hypothec to be a fixed security arising by operation of law and many of whom criticised the decision in *Cumbernauld Development*.⁹⁶⁶ He explained that the landlord's hypothec is a real right in security, and a fixed security arising by operation of law,⁹⁶⁷ which sequestration for rent "merely seeks to enforce".⁹⁶⁸ Despite the subsequent abolition of sequestration for rent, the landlord's hypothec retains its ranking preference over a floating charge⁹⁶⁹ and would receive priority over a chargeholder acting through a liquidator, receiver or administrator.

The recognition of the landlord's hypothec as a fixed security arising by operation of law corresponds to what was intended when the floating charge and the relevant statutory wording were first introduced. In the *Eighth Report*, it was proposed that if any assets were subject to a floating charge and a landlord's hypothec or a fixed security then the hypothec or fixed security should, by default, have priority.⁹⁷⁰ At this stage, there was no reference to other tacit securities. The 1961 Act retained the general rule specified in the *Eighth Report* but modified

⁹⁶¹ It is, however, unclear if a tacit security created after the charge's attachment would rank ahead of the charge.

⁹⁶² N 736.

⁹⁶³ Under the 1972 Act, s 31(1).

⁹⁶⁴ At 57.

⁹⁶⁵ N 736.

⁹⁶⁶ Eg GL Gretton, "Receivership and Sequestration for Rent" 1983 SLT (News) 277; JM Halliday, *Conveyancing Law and Practice in Scotland*, vol 1 (1985), para 2-114 and vol 3 (1987), para 41-24; Wilson, *Debt*, para 9.11, n 68.

⁹⁶⁷ Under 1985 Act, s 486(1), and 1986 Act, s 70(1), as it is treated as an effective security in the winding up of a company.

⁹⁶⁸ At 39, where he cited cases in support.

⁹⁶⁹ 2007 Act, s 208(1) and (2).

⁹⁷⁰ *Eighth Report*, Appendix II, para 4. The charge would, however, have priority over the fixed security if there was a negative pledge and the fixed security holder had actual notice of that prohibition. (Registration in the charges register was to constitute actual notice (para 5).) This rule was not to apply to the landlord's hypothec.

it. The reference to landlord's hypothec was replaced with the wider term "fixed security arising by operation of law".⁹⁷¹ In the Scottish Standing Committee, Forbes Hendry specified that the term principally meant the landlord's hypothec but also included the solicitor's hypothec and the repairer's lien.⁹⁷² Viscount Colville, in the House of Lords, similarly referred to the landlord's hypothec but also mentioned maritime hypothecs (liens) as falling within the term's scope.⁹⁷³ The term was therefore wide-ranging and inclusive of various tacit security rights.

In addition to those particular security rights mentioned, the term also seems to extend to other forms of lien. All liens are securities that arise by operation of law and have the same subordinate real right nature.⁹⁷⁴ Furthermore, in Parliament no distinction was drawn between general liens and special liens and thus the statutory term apparently encompasses both types.⁹⁷⁵ Statutory liens, such as the lien of a seller in possession, which arises "by implication of law" under s 39(1)(a) of the 1979 Act, are most probably included as well.⁹⁷⁶ All of this, in combination with the legislative ranking provisions for (voluntary) fixed securities and (effectually executed) diligence, indicates the intended comprehensive nature of the floating charge ranking provisions, at least as regards subordinate real rights in security.

⁹⁷¹ 1961 Act, s 5(1).

⁹⁷² Scottish Standing Committee, 20 June 1961, cols 24-25. In the past, the solicitor's lien (a separate security right) was commonly referred to as the solicitor's hypothec: see Steven, *Pledge*, para 14-09.

⁹⁷³ HL Deb, 5 July 1961, vol 232, col 1439.

⁹⁷⁴ On the last point, see the reasons given by Steven, *Pledge*, ch 14.

⁹⁷⁵ For details of special lien, see Steven, *Pledge*, ch 16. And see ch 17 for details of general lien. It seems to generally be assumed that the term "fixed security arising by operation of law" includes all liens: see eg Wilson, *Debt*, para 9.10, who simply states that lien falls within the meaning.

⁹⁷⁶ See s 41 for the lien's scope. This lien may also follow on from the seller re-acquiring possession following the right of stoppage in transit: ss 39(1)(b) and 44ff.

CHAPTER 9

THE FLOATING CHARGE AND INCORPOREAL PROPERTY

A.	INTRODUCTION	233
B.	ATTACHMENT AND ASSIGNATION	234
(1)	General.....	234
(2)	<i>Sharp v Thomson</i>	238
C.	ATTACHMENT AND ASSIGNATION IN SECURITY	240
(1)	Nature of Assignment in Security	240
(2)	Attachment and Ranking Paradox.....	243
(3)	Fixed Security?	245
D.	ATTACHMENT AND ASSIGNATION IN SECURITY: SOLUTIONS?	248
(1)	A Subordinate Right?	248
(2)	Trust	261
(3)	Grant in Breach of Negative Pledge is Non-Divestive?	263
(4)	<i>Sharp v Thomson</i>	264
(5)	Non-Attachment	265
(6)	Legislation	265

A. INTRODUCTION

This chapter examines the relationship between floating charges and incorporeal property. Its content applies to rights transferred by assignment and for which assignment in security is an applicable form of security, and is currently the only form of voluntary security available (excluding floating charges). The chapter therefore covers personal rights, heritable and moveable.⁹⁷⁷ The discussion and conclusions regarding the transfer of incorporeal property and the floating charge also apply to many real rights, but not to the ownership of corporeal moveable and corporeal heritable property. And the material relating to assignment in security

⁹⁷⁷ Eg contractual rights relating to land, such as claims arising from missives, as well as contractual and other claims unrelated to land, like “book debts”. Paisley, *Land Law*, para 1.22, suggests that for incorporeal property it is often more appropriate to distinguish between personal and real rights rather than incorporeal heritable and incorporeal moveable property.

excludes standard securities and other real rights in land requiring registration, as security over these require to be in the form of a standard security.⁹⁷⁸

Yet the main focus of the chapter is personal rights, for which transfer, absolutely or in security, is completed by intimation of the assignation to the (claim) debtor.⁹⁷⁹ The question of whether personal rights can be “owned” and/or made subject to subordinate “real rights” is controversial and complex.⁹⁸⁰ For the sake of consistency with the standard approach in Scots law, references will be made to the “ownership” of incorporeal property, and to other “real rights” in such property.

The present chapter specifically considers when incorporeal property becomes attachable and unattachable by a floating charge when it is being transferred by assignation. As well as examining the general legal position, it is necessary to consider the implications of *Sharp* for incorporeal property. It will then be shown that there is a significant problem involving the relationship between the floating charge and property assigned in security, within the context of the attachment and ranking of the floating charge. Finally, potential solutions to this problem will be considered.

B. ATTACHMENT AND ASSIGNATION

(1) General

Incorporeal property falls within the general scheme of property law in Scotland.⁹⁸¹ The term “property” in the floating charges legislation is all-encompassing and there are no separate provisions that exclude particular property types. A floating charge may, therefore, be granted over all or part of a company’s incorporeal property, and the charge, in principle, can attach to such property.

⁹⁷⁸ See 1970 Act, s 9(2), (3) and (8)(b). Non-registrable real rights in heritable property, such as short leases, are exceptions, but security over these are taken by assignation and possession (which, like intimation, causes ownership to transfer). It is possible to have a system with alternative security options of assignation in security *and* a subordinate right in security: see eg the proposals in SLC, *Moveable Transactions*, especially ch 3.

⁹⁷⁹ Assignations of real rights are completed by an alternative to intimation, such as the giving of possession or registration.

⁹⁸⁰ See, in particular, Gretton (n 339), who answers this in the negative. Cf Reid, *Property*, para 16. See also Anderson, *Assignment*, para 1-09.

⁹⁸¹ Reid, *Property*, para 1.

Anderson, however, suggests that a case can be made for floating charges not attaching to incorporeal moveable property such as money claims.⁹⁸² A floating charge attaches “as if” it is the relevant form of “fixed security” for the property in question and for money claims there is no right in security in the strict sense. The particular security for that property is assignment in security, which is a functional security (see below). Yet it is difficult to contend that such property will not be subject to the charge. Firstly, there is much judicial authority, including the First Division decisions in *Iona Hotels, Forth & Clyde* and *Lord Advocate v RBS*, in which the floating charge has been held to attach to incorporeal moveable property. Secondly, in cases such as *Iona Hotels* and *Forth & Clyde*, the definition of “fixed security” has been considered wide enough, and functionalist enough, to enable a floating charge to attach “as if” it is an assignment in security. And if, instead, the charge was intended to attach as a *sui generis* security effective in a liquidation, the charge would almost certainly attach to incorporeal property. Thirdly, and related to the last point, the fact that the *effect* of attachment may not fit with the nature of security available for incorporeal property primarily raises doubts about the currently prevailing statutory hypothesis, rather than whether the property is attached. The attachment mechanism relies on the general concept of an effective security in the company’s liquidation, and the point made by Anderson strengthens the view that the charge attaches as a *sui generis* security. Finally, the original floating charges legislation was intended to enable the charge to attach to incorporeal property and all other property types.⁹⁸³ There is nothing to suggest that this has been departed from in later legislation.

Incorporeal property is part of a unitary law of property and its transfer is analogous to transfer for other property types.⁹⁸⁴ Consequently, much of what has been written in other chapters about the general attachability and non-attachability of a charge during the transfer process also applies to incorporeal property. Attachment ordinarily depends upon the chargor owning the relevant property. This ought to be the key determinant throughout the transfer process (but see the discussion of *Sharp’s* application below). For example, A Ltd grants a floating charge to B Bank. A Ltd is due £50,000 from a customer, X Ltd. As a result of cash flow issues, A Ltd seeks immediate funds from C Ltd (a debt factoring company). C Ltd had earlier granted a floating charge to D Bank. In return for £40,000, A Ltd assigns the claim against X Ltd to C Ltd.

⁹⁸² Anderson, *Assignment*, para 7-36.

⁹⁸³ See eg *Eighth Report*, para 30.

⁹⁸⁴ See eg Anderson, *Assignment*, para 1-07.

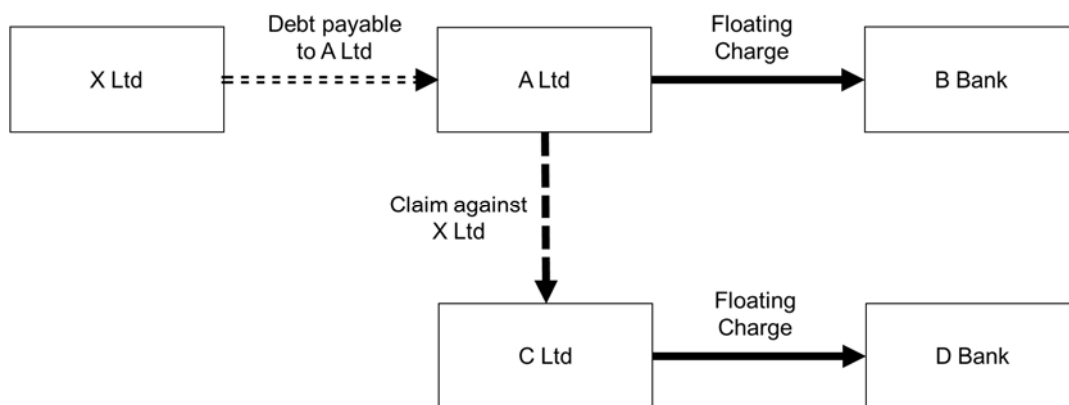

While the property belongs to A Ltd, it is potentially attachable by B Bank’s charge. After it is transferred to C Ltd, it falls within the ambit of D Bank’s charge. And, of course, the charges can attach to any personal rights that the relevant chargor has against the other party involved in the transfer. The claim against X Ltd transfers when the assignment is intimated to X Ltd.⁹⁸⁵ At this point, it leaves A Ltd’s patrimony and enters C Ltd’s. Meanwhile, the sum paid by C Ltd leaves that party’s patrimony and enters A Ltd’s when that payment is made.

Thus, where an assignment is in competition with a floating charge it is not strictly a ranking question but, rather, an attachment one. If incorporeal property is transferred prior to the charge’s attachment, the charge will not attach to it. This means that, for example, the “circle of priority” involving a floating charge, intimated assignment and arrestment, allegedly arising from the interpretation of effectually executed diligence in *Lord Advocate v RBS*, could not occur.⁹⁸⁶ The floating charge would not attach to the assigned property and therefore the

⁹⁸⁵ See Anderson, *Assignment*, paras 6-01ff, and the sources cited there. In that chapter and the following one, Anderson discusses the requirements for a successful intimation. See also Gloag and Irvine, *Security*, 476ff.

⁹⁸⁶ For the circle of priority, see AJ Sim, “The Receiver and Effectually Executed Diligence” 1984 SLT (News) 25; Wilson, *Debt*, para 17.14; Wortley, “Squaring the Circle”.

competition would only be between the arrestment and the assignation.⁹⁸⁷ In any event, the recent decision in *MacMillan* apparently means that such a “circle” could no longer appear.⁹⁸⁸

Another point to consider at this stage is that there are a number of situations in which personal rights are non-transferable: if they involve *delectus personae*, such as where assignation is prohibited expressly by contract or in statute. Professor Reid notes that, in these instances, the purported transfer would be void.⁹⁸⁹ Therefore, if the agreement between A Ltd and X Ltd expressly stated that A Ltd’s claim for payment was non-assignable, the purported transfer to C Ltd would be ineffective.

A related issue is whether such non-assignability would preclude B Bank’s charge from attaching to the property. If the charge attaches as if it is an assignation in security, then there is force in the view that attachment is ineffective. Yet it depends on how far this hypothesis is taken. Clearly there has actually been no assignation, and realisation is dependent upon a party acting as agent of the company in relation to *the company’s* property. Unlike in sequestration, there is no automatic vesting effect, equivalent to assignation, for receivership, liquidation or administration, and this further undermines the view that a charge’s attachment will be rendered invalid by the prohibition. A liquidator, receiver or administrator would apparently not be able to realise the claims by selling and transferring them to a third party; however, they could simply wait for a claim debtor to perform to the chargor and then distribute received sums to the chargeholder. There would be no obvious prejudice to the debtor in such circumstances. Even if there was vesting in a liquidator, as is possible under the 1986 Act, s 145, the charge could probably still be enforced through the liquidator; Anderson convincingly argues that a *pactum de non cedendo* in the underlying contract (eg the agreement between A Ltd and X Ltd) “cannot have any effect on involuntary assignments”.⁹⁹⁰

⁹⁸⁷ The position may be different where the assignation is in security (see below), and certainly would be different if a real security right was available and was granted instead. It should also be noted that an assignation in breach of an arrestment may be ineffective against the arrester alone or absolutely. However, the circle will still not arise: in the first case because the charge will not attach and in the second because the assignee will not enter the ranking contest.

⁹⁸⁸ As a bare arrestment will rank ahead of a floating charge as effectually executed diligence. It will, however, be rendered ineffectual if executed within 60 days of the chargor’s liquidation.

⁹⁸⁹ Reid, *Property*, para 652. And see *Apollo Engineering* (n 91); and McBryde, *Contract*, paras 12-47f. For discussion of anti-assignation clauses in the context of the Scottish Law Commission’s “Moveable Transactions” reform project, see SLC, *Moveable Transactions*, paras 3.13, 4.11ff and 14.52ff.

⁹⁹⁰ Anderson, *Assignation*, para 11-42. (Albeit that this is mentioned when he is discussing sequestration.)

If the charge attaches as a *sui generis* security, then there is an even weaker argument for the attachment being ineffective for non-assignable property, as there would be no assignation, deemed or otherwise. However, whichever view of the charge's attachment mechanism is adopted, a specific prohibition on charging, or otherwise using the property for security purposes, seems more likely than a prohibition on assignation to render a floating charge unattachable to the property. This unattachability would seem to be based on the property not being part of the chargor's "property and undertaking", as regards floating charges.

A further relevant issue, dependent upon the effect of attachment, is whether or not it is possible for property to be assigned after attachment takes place. The interpretation in *Forth & Clyde*,⁹⁹¹ that a charge attaches as if it is an assignation in security, seems to mean that an assignation completed after the attachment will be ineffective due to the *nemo plus* rule (if *Sharp* does not apply); the chargeholder, and not the granting company, would have become the deemed owner of such property. If, however, the charge attaches as a right in security *sui generis*, and there is no deemed transfer, then it would be possible for the property to pass to the assignee after attachment. But, as noted in chapter 6, a post-attachment transfer would only be valid if the assignee had the power to obtain ownership unilaterally.

(2) *Sharp v Thomson*

As discussed previously, there is uncertainty as to whether the ratio from *Sharp* extends to the transfer of incorporeal property. Like for corporeal heritable property, there are three general stages where property is transferred by assignation: contract, delivery of the assignation and intimation to the original debtor (or an equivalent). This has led some commentators to argue that for property transferable by assignation, or another three-stage process, applying *Sharp*'s ratio is inescapable.⁹⁹² Certainly, there is some comparability between delivery of a disposition and delivery of an assignation: each gives the recipient the power to become owner of the property by completing the final transfer step.⁹⁹³

⁹⁹¹ Per LP Emslie at 10f.

⁹⁹² See n 740 and eg Birrell (n 726) at 152f; RB Wood, "Special Considerations for Scotland" in *Salinger on Factoring*, 4th edn by N Ruddy et al (2006), para 7.47. In the most recent edition of *Salinger on Factoring* (5th edn by S Mills et al (2017)), Wood, at para 7.48, also states that a factor would prevail against a receiver even without intimating an assignation.

⁹⁹³ The Requirements of Writing (Scotland) Act 1995, s 11(3)(a), disapplied any rule of law whereby the assignation of incorporeal moveables required to be in writing. For discussion of this and the seeming inconsistency with the writing requirement for intimation, see Anderson, *Assignation*, paras

Yet the difficulties of *Sharp* support taking a tightly confined view of the case's ratio. A number of problems arising from applying *Sharp* to assignation are noted by Anderson.⁹⁹⁴ He identifies, *inter alia*, the possibility of a verbal assignation, without intimation, causing an assignee to be preferred over a chargeholder, as well as "whimsical" rules of competition for creditors. In addition, there is an apparent inconsistency between the non-attachment of a cedent-granted charge, if payment is made and a deed of assignation is delivered, and the fact that an assignee would not prevail against a liquidator unless intimation had taken place.⁹⁹⁵ The absence of automatic vesting for corporate insolvency processes does, however, raise the possibility that an assignee could intimate and thereby obtain the property before realisation by the liquidator or equivalent.⁹⁹⁶ On one view, this would also defeat a charge, whether or not *Sharp* is correct. Nevertheless, the lack of coherence between non-attachment, based on *Sharp*, and the assignee's minimal entitlement in the cedent's insolvency (in the absence of intimation) is noteworthy, especially since the charge is enforced in liquidation and related processes. Anderson suggests that, under the current law, it appears that if an assignation is paid for and the deed has been delivered the relevant claim will not be subject to the charge, as beneficial interest has passed. However, he states that, with respect to assignees with unintimated assignations in competition with chargeholders, there is "little to support their position in principle".⁹⁹⁷ This is certainly true, and raises the question of why *Sharp* should be considered to apply to incorporeal property.

It might be possible to limit *Sharp* to (corporeal) heritable property on the basis that it is anomalous and reflects certain case law describing the effects of delivery of a disposition for heritable property, and the consequent meaning of the statutory term "property and undertaking" in this context. There is less authority for delivery of an assignation (or verbal assignation) having an equivalent proprietary transfer effect for incorporeal property⁹⁹⁸ and, due to the problems emanating from *Sharp*, the case's effects ought to be circumscribed. The ratio should not be extended beyond heritable property unless there is good reason to; and

6-35, n 121, 7-17 and 7-33. However, the 2012 Act has repealed s 11 of the 1995 Act. The current position regarding the necessity of writing for assignation is unclear.

⁹⁹⁴ Anderson, *Assignation*, paras 7-33ff.

⁹⁹⁵ As the assignee would only have a personal right against the company. This would probably be of no real value in the company's insolvency.

⁹⁹⁶ See eg Wilson, *Debt*, para 25.7.

⁹⁹⁷ Anderson, *Assignation*, para 7-37.

⁹⁹⁸ The position where an assignation has been delivered but is unintimated is not, however, entirely straightforward: see *ibid*, paras 7-25ff.

such reason is absent for incorporeal property. This is admittedly controversial, but it is surely irrational to extend the ratio of a flawed case to new situations where: (i) it does not fit doctrinally; (ii) it raises a plethora of practical problems; and (iii) its policy justifications are questionable and limited in scope.

C. ATTACHMENT AND ASSIGNATION IN SECURITY

(1) Nature of Assignment in Security

The consensus position is that an assignation in security has the same effect as an absolute assignation: the cedent is divested and the property transfers to the assignee.⁹⁹⁹ The cedent, however, has a personal right, and the assignee a corresponding obligation, for the property to be retrocessed (retransferred) upon the fulfilment of the secured obligation(s). This is not a subordinate right in security but, rather, a *fiducia cum creditore* security.¹⁰⁰⁰ Apart from the floating charge, it is the only voluntary security available over many types of incorporeal property.¹⁰⁰¹

The SLC has recently stated that:

since an assignation in security is an assignation, the general law of assignation applies... Assignation in security is not a distinct institution from assignation. It is the identical institution. What distinguishes assignation in security from outright assignation is purpose.¹⁰⁰²

⁹⁹⁹ See eg Gretton, “Concept of Security”, 130; Sim, “Rights in Security”, para 46; Anderson, *Assignment*, para 7-36; WM Gloag and RC Henderson, *The Law of Scotland*, 13th edn by Lord Eassie and HL MacQueen (2012), para 36.28. See also Wilson, *Debt*, para 8.1, who states: “A security over incorporeal moveables is effected by assignation followed by intimation”.

¹⁰⁰⁰ See Anderson, *Assignment*, para 7-36, who refers to assignation in security as the converse of retention of title in the sale of corporeal moveables.

¹⁰⁰¹ See eg *National Westminster Bank plc v Spectrum Plus Ltd* [2005] UKHL 41; [2005] 2 AC 680, per Lord Hope at paras 51 and 54, who states that the only way a “fixed charge” can be created over book debts in Scots law is by assignation in security of the right to receive payment, followed by intimation to the claim debtor.

¹⁰⁰² SLC, *Moveable Transactions*, para 7.6. Treatments of assignation in security tend to consider various aspects of assignation, supplemented by rules particular to assignation in security: see eg Gloag and Irvine, *Security*, ch 14; Sim, “Rights in Security”, paras 46ff. See eg *Campbell's Trs v Whyte* (1884) 11 R 1078 for a competition between an absolute assignation and an assignation in security.

While an absolute assignation is usually intended as a permanent transfer,¹⁰⁰³ assignation in security provides security for an obligation (or obligations) and, therefore, it is anticipated that the property will eventually be retrocessed. The retrocession, as an assignation, will also have to comply with general requirements for that type of transfer, including intimation.¹⁰⁰⁴

Even if there is no patrimonial or property distinction between an absolute assignation and an assignation in security, differences in accompanying obligations, particularly the assignation in security requirement to retrocess upon obligational fulfilment, can lead to varying outcomes.¹⁰⁰⁵ Other relevant obligations include the requirement for the assignee to account to the cedent with sums received from a claim debtor, after satisfaction of the debt due to the assignee. If this obligation is not expressly stated in the assignation it will be implied, due to the security nature of the transaction.

A further difference between absolute assignations and assignations in security, as regards cedent companies, is that the latter require to be registered in the charges register to be effective against creditors, while the former do not.¹⁰⁰⁶ The registration may have significant implications in certain respects, such as for the application of the offside goals rule.¹⁰⁰⁷ A party dealing with the assignee could become aware of the secured nature of the assignation, and thus the retrocession (reversionary) right, by examining the charges register for the cedent, or the assignation deed itself might disclose this.¹⁰⁰⁸ Such information would probably impose a duty of inquiry upon the prospective transferee to determine whether the original assignee remained subject to an obligation not to transfer the property.¹⁰⁰⁹ Yet the precise extent of the offside goals rule is unclear, including whether it would extend to protect a retrocession right that was still conditional upon the debtor satisfying the secured debt.

¹⁰⁰³ There could, however, be an option for the cedent to repurchase.

¹⁰⁰⁴ See *Microwave Systems (Scotland) Ltd v Electro-Physiological Instruments Ltd* 1971 SC 140; AM Bell, *Lectures on Conveyancing*, 3rd edn (1882), vol 1, 335; J Craigie, *Scottish Law of Conveyancing: Moveable Rights*, 2nd edn (1894), 263; McBryde, *Contract*, para 12-104 and n 387. And see *Craig v Edgar* (1674) Mor 838. The Transmission of Moveable Property (Scotland) Act 1862, s 4, includes retrocessions and translations within the term “assignation”.

¹⁰⁰⁵ *Compagnie Commerciale Andre SA v Artibell Shipping Co Ltd* 2001 SC 653; McBryde, *Contract*, para 12-07. See also Anderson and Biemans (n 154) at 28 and n 15.

¹⁰⁰⁶ At 2006 Act, s 859A(7) assignations in security are expressly included within the term “charge”. There is no distinction drawn between assignations expressly in security and those which are *ex facie* absolute; the definition presumably includes both.

¹⁰⁰⁷ In addition, failure to register timeously will mean the assignation in security is void against creditors and a liquidator or administrator. However, it will seemingly be valid to obtain payment from a claim debtor.

¹⁰⁰⁸ Such checks would usually be expected within a commercial context.

¹⁰⁰⁹ See eg *Rodger (Builders) Ltd v Fawdry* 1950 SC 483; and Reid, *Property*, paras 695ff.

Assignations in security may be in one of two general forms: (i) expressly in security; or (ii) *ex facie* absolute qualified by back letter or other agreement. The former disclose within the assignation deed that their purpose is one of security, while the latter appear, from the deed, to be (non-security) absolute transfers. The following diagram is a simple illustration of the sub-categorisation of assignation to include assignation in security. Retrocession is an absolute assignation.

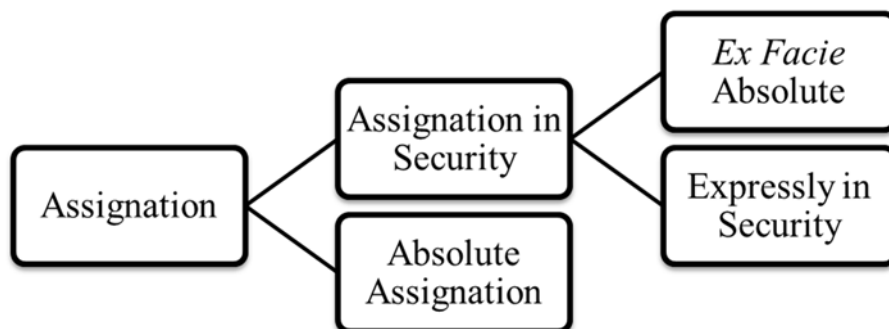

There are a number of potential consequences arising from the distinction in form between assignations *ex facie* absolute and expressly in security. One difference relates to the amount of debt which the particular assignation is presumed to provide security for. Assignations expressly in security are presumed to be limited to present and future sums for which the security was specifically granted.¹⁰¹⁰ The presumption can, however, be overcome where the deed states that the security is for all sums due and to become due.¹⁰¹¹ It can also be overturned where further advances by the creditor are made expressly in reliance upon the security.¹⁰¹² Assignations *ex facie* absolute ordinarily entitle the assignee to hold the property until all outstanding sums have been paid (ie for all sums due and to become due); however, a separate agreement could provide that the property is only to be held for a specific sum.¹⁰¹³

¹⁰¹⁰ *National Bank of Scotland v Forbes* (1858) 21 D 79; Gloag and Irvine, *Security*, 491; Stewart, *Diligence*, 151ff; Sim, “Rights in Security”, para 53.

¹⁰¹¹ See eg Anderson and Biemans (n 154) at 27f.

¹⁰¹² *Clyne v Dunnet* (1833) 11 S 791 affd (1839) MacL & R 28; *Forbes* (n 1010) per Lord Ordinary’s Note at 83; Gloag and Irvine, *Security*, 491; Stewart, *Diligence*, 153f.

¹⁰¹³ See eg *Robertson’s Trustee v Union Bank of Scotland* 1917 SC 549; *National Bank of Scotland v Dickie’s Trustee* (1895) 22 R 740 per Lord McLaren at 753; Gloag and Irvine, *Security*, 491f; Stewart, *Diligence*, 151; Sim, “Rights in Security”, para 53. And see, more generally, *Hamilton v Western Bank* (n 802). See also Anderson and Biemans (n 154) at 27f, who note that for *ex facie* absolute assignations granted by a company or LLP, where the sum contained in the back-bond

The extent of any assignation in security is, in any event, restricted to the amount outstanding, or already agreed to later become due, when: (i) an assignation of the cedent's retrocession right is intimated to the assignee in security;¹⁰¹⁴ (ii) there is an arrestment in the assignee's hands;¹⁰¹⁵ or (iii) the cedent enters bankruptcy (or equivalent).¹⁰¹⁶ Assigned property beyond the secured amount is available to the cedent's creditors, due to the cedent's retrocession right.¹⁰¹⁷

Over time, certain other points of contrast between the two forms of assignation in security have been suggested. Some of these relate to the effect of the assignations in proprietary terms. Such analysis is rejected by the modern consensus position but is discussed in more detail below. On a similar note, it has also been contended that assignation expressly in security does not give the assignee the power to transfer the property, as his title is qualified.¹⁰¹⁸ The position is contrasted with assignation *ex facie* absolute, where there is such a power. This seems to mistake a power of transfer with the *right* to do so. A transfer will breach the contractual obligation to the original cedent but the transfer will be valid;¹⁰¹⁹ however, it could be challengeable under the offside goals rule if the transferee was in bad faith or a donee. Only the debtor and creditor in the underlying claim would be able to place restrictions on the transferability of the claim, by limiting the property itself through those conditions.¹⁰²⁰

(2) Attachment and Ranking Paradox

If the proprietary effects of assignation in security and absolute assignation are the same, then property successfully assigned in security by A Ltd to C Ltd is no longer attachable by B Bank's floating charge. The charge could only attach the retrocession right. D Bank's charge

is increased, the increase creates an additional charge and requires further registration in the charges register.

¹⁰¹⁴ *National Bank v Union Bank* (n 803); Gloag and Irvine, *Security*, 492.

¹⁰¹⁵ *Bank of Scotland v Macdonell* (1826) 4 S 804; Stewart, *Diligence*, 151. See also *Clyne* (n 1012).

¹⁰¹⁶ Gloag and Irvine, *Security*, 492. See also Gloag, *Contract*, 640ff.

¹⁰¹⁷ Stewart, *Diligence*, 154.

¹⁰¹⁸ Unless a power of disposal is expressly conferred: Gloag and Irvine, *Security*, 492. This is also discussed by Gow, *Mercantile Law*, 285f (and see 258f below).

¹⁰¹⁹ Before the transfer takes place, the cedent could use interdict to stop it.

¹⁰²⁰ See above. The distinction between conditions *in corpore juris* and *extra corpore juris* is especially relevant here. For these concepts, see Bell, *Commentaries*, I, 284ff; and Reid, *Property*, para 660.

could apparently attach to the transferred property, and would be able to do so unless and until retrocession took place.

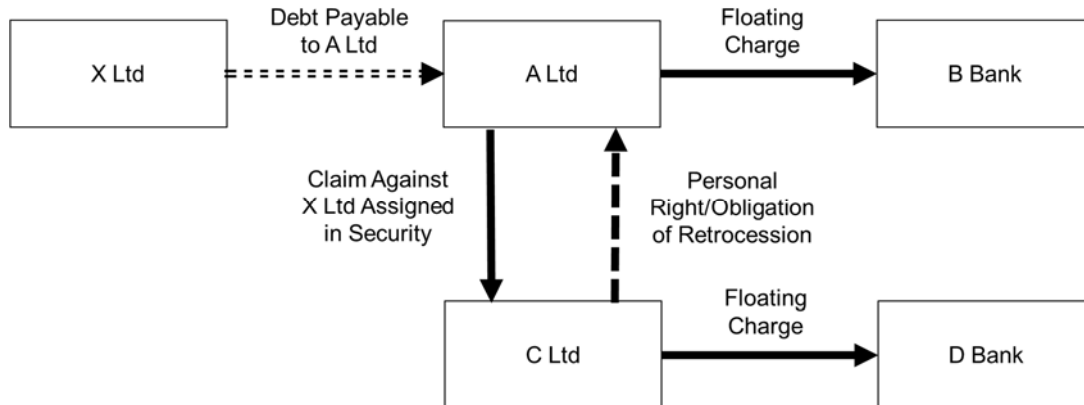

A serious problem emerges, however, if we examine this attachment situation alongside the statutory ranking provisions. If the floating charge instrument contains a negative pledge prohibiting the creation of later fixed securities, the charge will have priority over any such fixed security subsequently created.¹⁰²¹ If there is no negative pledge, a fixed security has priority of ranking over a floating charge where the fixed security “has been constituted as a real right before a floating charge has attached to all or any part of the property of the company”.¹⁰²² Conversely, where the fixed security is not constituted as a real right prior to the attachment of the floating charge, the latter has priority.

If an assignation in security is a “fixed security” then these provisions foresee that a floating charge can rank ahead of an assignation in security, where the floating charge attaches prior to the assignation in security being constituted as a “real right”.¹⁰²³ There is no specification as to the type of real right, ie whether it must be a subordinate real right or if it can also be the transfer of ownership in security. However, the relevant sub-section’s reference to “the property of the company” suggests that attachment may be a necessary condition for ranking.

¹⁰²¹ Under the 1985 Act, s 464(1)(a) and (1A).

¹⁰²² Ibid, s 464(4)(a).

¹⁰²³ It could be argued that the constitution of a fixed security as a “real right” means the provision is inapplicable to securities over personal rights because these, under one analysis, cannot be the subject of real rights. For this analysis, generally, see Gretton (n 339). It can be assumed that the provisions were introduced on the basis of the traditional property analysis: for which, see Reid, *Property*, para 16.

More significantly in practice, the ranking provisions suggest that an assignation in security granted in breach of a negative pledge will be postponed in ranking to the floating charge. Yet the assignee will have the property, and the cedent-granted charge will only attach to the personal right of retrocession. There is thus an inconsistency, or paradox, as the ranking provisions suggest a charge ought to be able to prevail against an assignation in security but this is at odds with the attachment provisions.

If the assignation in security ranks ahead of the charge, then it will often be of minimal consequence whether or not the charge formally attaches to the property. C Ltd will be required to give surplus proceeds to A Ltd, or to retrocess the property, when the secured debt is satisfied. If B Bank's charge has not yet attached when such proceeds are received by A Ltd or when assigned property is returned, these things will become potentially attachable. And where B Bank's charge has already attached to the retrocession right, or right to receive surplus proceeds, then the transferred property will replace this property and itself be attached.¹⁰²⁴ But if C Ltd becomes insolvent the property would be expected to be part of its insolvent estate and A Ltd's rights against C Ltd are only personal. Therefore, B Bank's charge would only attach such rights and would not confer a priority over the rights of C Ltd's creditors as regards the property.

(3) Fixed Security?

The paradox involving attachment and ranking is dependent upon assignation in security being a fixed security. If it is not, then the assignation in security will be treated like a "normal" transfer and will be unattachable. The definition of fixed security refers to security rights that would be effective in a winding up of the company, and, therefore, it is apparently intended to integrate the term within the wider Scots law of security rights. In this context, it is true that the terms "security" and "security rights" in Scots law often include functional securities, as well as real rights in security.¹⁰²⁵ And it has been judicially recognised that an assignation in security is the only form of "effective security" for certain incorporeal property, eg "book

¹⁰²⁴ See 62ff.

¹⁰²⁵ But there can sometimes be confusion as to the distinctions between "security rights", "real rights in security" and "fixed securities". In Gloag and Henderson, *The Law of Scotland* (n 999), para 36.05, it is stated that: "A fixed security is a subordinate real right in security over some specific property." Under the current law, fixed securities are, however, deemed to extend to (certain) functional securities.

debts”, and therefore is the only “fixed security” for such property.¹⁰²⁶ Commentators such as Professor Wilson have also stated that an intimated assignation in security is a “fixed security” and becomes a real right by virtue of its intimation.¹⁰²⁷

If fixed security is given such a functionalist meaning, it would seem that assignments expressly in security *and* assignments *ex facie* absolute, but truly in security, both fall within its ambit due to their common purpose.¹⁰²⁸ This also enables these security rights to be distinguished from absolute assignation, which does not purport to provide security and therefore is not a “fixed security”.

On the other hand, it is possible to interpret the definition of fixed security as only applying to property that actually belongs to the chargor company. Assignation in security is an effective security in the company’s liquidation, but this is because it removes the property from the company’s patrimony. In the terms used by German law, it gives the assignee an *Aussonderungsrecht*, a right that allows for property to be separated from the insolvent estate. This contrasts with an *Absonderungsrecht*, which is a right relating to property that falls within the insolvent’s estate, but which, dependent on the security in question, might enable realisation by the security holder.¹⁰²⁹

In determining whether assignation in security is a “fixed security”, it is also instructive to consider the term’s legislative history. As noted in chapter 7, the original definition expressly referred to *ex facie* absolute assignation qualified by back letter.¹⁰³⁰ But, from the 1972 Act onwards, that was replaced by reference to security in terms of the 1970 Act. This indicates that the assignation reference was (largely) focused upon the assignation of real rights in

¹⁰²⁶ *Forth & Clyde* per LP Emslie at 10f; *Iona Hotels* per LP Hope at 336. See also *Spectrum Plus* (n 1001), per Lord Hope at paras 51 and 54.

¹⁰²⁷ WAW, “Effectively Executed Diligence” 1978 JR 253 at 255.

¹⁰²⁸ In *Forth & Clyde*, counsel for the reclaimers argued (see at 7) that attachment did not cause a floating charge to take the form of an assignation in security, and noted that there are differences in the rights conferred by assignation expressly in security and assignation *ex facie* absolute qualified by back letter. However, the court decided that the charge attached as an assignation in security, without further specification as to its form.

¹⁰²⁹ See InsO §47ff and 165ff InsO. And see CG Paulus and M Berberich, “National Report for Germany” in Faber, *Ranking* (n 611), paras 10.15f and 10.46f, who refer to *Aussonderungsrechte* as “rights to separation of assets from the estate” and *Absonderungsrechte* as “rights to claim privileged distribution of the proceeds”. Interestingly, however, the right held by a party with the German equivalent of an assignation in security is treated like an *Absonderungsrecht* (see 258ff below).

¹⁰³⁰ 1961 Act, s 8(1)(c). See 200 above.

heritable property, such as long leases.¹⁰³¹ However, comments made by Forbes Hendry suggest that fixed security was also (originally) intended to include the assignment of personal rights in security. He referred to an insurance policy with a surrender value on the life of a managing director of a company which might be assigned to a creditor by “assignment of security” [sic], and in relation to which a back letter would be issued.¹⁰³² The possibility of such assignments also being made expressly in security was not mentioned. But if assignment *ex facie* absolute is generally included within the meaning of fixed security then, *a priori*, assignment expressly in security ought to be too. Hendry also suggested that the proposed new s 106A of the 1948 Act, outlining “charges” requiring registration in the charges register to become effective, provided a “fairly comprehensive list” of potential fixed securities.¹⁰³³ These included a “charge on land” and “security over incorporeal moveable property”, which he stated was difficult to define but included security over book debts and intellectual property.¹⁰³⁴ It should be noted that the list is not truly comprehensive as other securities, such as pledge, which do not require to be registered, are undoubtedly also fixed securities.¹⁰³⁵

Despite Hendry’s comments, the specific inclusion of *ex facie* absolute assignment in the 1961 Act was presumably because of uncertainty as to whether it would meet the definition of fixed security, given that it involved an ostensible transfer to the creditor. Consequently, the apparent reason for its inclusion and its subsequent removal cast doubt upon whether it is a form of security now encompassed by the definition. Furthermore, as assignment expressly in

¹⁰³¹ Forbes Hendry stated that a disposition “technically” could only relate to “heritage” and anything that was not heritage, including a long lease, required to be transferred by an assignment – Scottish Standing Committee, 20 June 1961, col 34. The distinction between incorporeal heritable property and corporeal heritable property appears to have been overlooked.

¹⁰³² Ibid, col 34. However, Hendry, at col 44 (in the context of registration of charges), noted that companies have no life to insure. The Lord Advocate (at col 48) instead referred to insurance over stocks, in the context of discussing the liquidation of a company. It is true that a company does not have an insurable life but it could hold the interest in the policy as an assignee or the policy could be a key man policy.

¹⁰³³ Ibid, cols 16-17. The list appeared in the 1948 Act, s 106A(2), which was inserted by 1961 Act, Sch 2. 1948 Act, s 106A(2)(a), referred to a “charge on land” and specified that this included “a charge created by a bond and disposition or assignment in security or by an *ex facie* absolute disposition or assignment qualified by a back letter...”; s 106A(2)(c) separately referred to “a security over incorporeal moveable property” falling within certain categories of such property. The amended version of s 106A(2)(a), inserted by the Schedule to the 1972 Act, referred instead to a charge created as a heritable security under s 9(8) of the 1970 Act. The general form of s 106A(2)(c) persisted in the 1972 Act and in later equivalent legislation: 1985 Act, s 410(4)(c); 2006 Act, s 878(7)(b). The format of the current regime is, however, different: 2006 Act, ss 859Aff.

¹⁰³⁴ Scottish Standing Committee, 20 June 1961, cols 16-17.

¹⁰³⁵ The transfer of corporeal moveables in security is also not included: see 220ff above. And Hendry himself noted that security over certain types of incorporeal moveables had been omitted – Scottish Standing Committee, 20 June 1961, cols 43-45.

security also has the same divesting effect, there may also be doubts as to whether it too is excluded.

Even if assignation in security was intended to be a fixed security, there has been no real consideration within Parliament or otherwise, as to how its patrimonial consequences would affect attachment or ranking. In relation to the charge's introduction, there may have been an assumed equivalence with heritable property, where there was a clearer subordinate real right effect for a bond and disposition in security, and an *ex facie* absolute disposition was also widely believed to be non-divestive.¹⁰³⁶ The distinctive position of assignation in security for various property was overlooked when the 1972 Act was passed and reference to the 1970 Act was inserted in place of the existing references. The current legislation has therefore inherited serious problems involving assignation in security.

D. ATTACHMENT AND ASSIGNATION IN SECURITY: SOLUTIONS?

(1) A Subordinate Right?

The difficulty regarding the relationship between assignation in security and the floating charge arises because the former is considered to involve transfer of the property and the latter does not (usually) attach to property transferred by the chargor. Therefore, it would be resolved if assignation in security is not fully divestive.¹⁰³⁷ If the property itself is attached by the charge, the competing claims of the chargeholder and the assignee can be ranked and preference given to one or the other.

Despite the current supremacy of the fully divesting interpretation, Professor Gretton himself has noted that authority for the proposition is “sparse”.¹⁰³⁸ That is true, but one can find

¹⁰³⁶ See 195ff.

¹⁰³⁷ It might be thought that if the retrocession right has real effect this would resolve the problem. Such effect would enable the right to be enforceable against third party acquirers from the assignee; however, attachment to the assigned property seems necessary for the charge to prevail against the assignation in security. In any event, real status for the retrocession right is unlikely without statutory provision, as was required for heritable reversion rights (see n 798).

¹⁰³⁸ Gretton, “Concept of Security”, n 21. Anderson, *Assignment*, refers to assignation in security, eg at para 7-36, but does not consider it in detail.

authorities which favour both this view and the alternative. A court faced with a competition between an assignation in security and a floating charge could draw upon such sources.

(a) Institutional Writers

There is scant support for a non-divestment approach in the institutional writings. In fact, the institutional writers generally provide little separate treatment of assignation in security. It does though seem to be impliedly incorporated within some of their discussions of absolute assignation.

Stair states that an intimated assignation is a “full and complete transmission of the right assigned... and thereby the right of the cedent ceaseth, and the assignee becomes creditor”.¹⁰³⁹ In this context and elsewhere in his wide-ranging treatment of assignation, he does not expressly consider assignation in security. However, he does specify that the meaning of assignation is intended to include retrocession, which he describes as “the returning back of the right assigned”, and this suggests a divesting transfer both to and from the original assignee.¹⁰⁴⁰ Bankton’s treatment of the subject is in similar terms to Stair.¹⁰⁴¹

Erskine follows the earlier writers with respect to retrocession and intimation’s transference effect; however, unlike them, he directly refers to assignation in security (along with assignation in satisfaction of a debt).¹⁰⁴² There is no detailed consideration of the nature and effect of assignation in security, but his wording suggests that the assignee creditor receives and holds the property right and upon satisfaction would be obliged to return it to the cedent debtor.¹⁰⁴³

¹⁰³⁹ Stair, III, 1, 43.

¹⁰⁴⁰ Stair, III, 1, 3. Retrocessions are most commonly used within the context of assignation in security in modern law: see eg McBryde, *Contract*, para 12-104. This was the case in the late-nineteenth century too: AM Bell, *Lectures on Conveyancing*, 3rd edn (1882), vol 1, 335. The use of retrocessions in relation to assignations in security would also have been familiar in Stair’s time: eg *Gordon v Skeen and Crauford* (1676) Mor 7169, which Stair cites (III, 1, 21) as authority for an assignee’s back bond to an apprising being found effectual against his successors, involved an assignation *ex facie* absolute (but qualified by a backbond) which required to be re-transferred upon satisfaction of the debt.

¹⁰⁴¹ Bankton, II, 191f. He cites *Craig v Edgar* (n 1004). MacKenzie, *Institutions*, III, V, in his brief treatment of assignation, does not mention assignation in security or retrocession.

¹⁰⁴² Erskine, *Institute*, III, V, 1 and 8. See also eg *Purnell v Shannon* (1894) 22 R 74 in which the First Division considered whether a particular assignation was an assignation in security or an assignation in satisfaction of a debt.

¹⁰⁴³ Erskine, *Institute*, III, V, 8.

Of the institutional writers, Bell's consideration of assignation in security is the most detailed, and seems to reflect the development of a more discrete law of security rights. He discusses assignation in security within the context of security over moveable property.¹⁰⁴⁴ In that section on security, Bell states that "ordinary debts", and incorporeal property generally, are "transferred by written deed of conveyance".¹⁰⁴⁵ Here, he draws no distinction between the nature or consequences of assignation absolutely and assignation in security.¹⁰⁴⁶

Assignation in security is, however, also dealt with by Bell within his analysis of the "pledge of debts".¹⁰⁴⁷ He specifies that debts (money claims) and other incorporeal property may be assigned in security and "such assignation sufficiently answers all the purposes of commerce, while it may, in one sense, be called a pledge."¹⁰⁴⁸ Yet he correctly states that corporeal moveables are the "proper subjects of pledge", due to the requirements of delivery and possession. Consequently, there is a general "legal impracticability" in the pledging of incorporeal rights, such as debts.¹⁰⁴⁹ His statements should be interpreted to mean that an assignee would have the right to retain incorporeal property, and not retrocede, until satisfaction of the secured debt; however, it would be possible to use his comments as a launching point for a view that assignation in security can create a subordinate pledge-style right.

(b) Judicial Authority Contrary to Full Divestiture

There are cases, particularly from the post-institutional period between the mid-nineteenth century and early twentieth century, but also before and after, in which one can discern judicial support for analysis contrary to the full-divestiture thesis. For example, courts have stated: (i)

¹⁰⁴⁴ Bell, *Commentaries*, II, 11 (for "assignation and disposition of moveables in security") and 16ff (for "transference of debts"). The material is contained within Book V, II "Of Voluntary Securities over Moveables", which itself is located in Book V "Of Real Securities over the Moveable Estate". Bell's use of "real securities" is a broader category than subordinate real rights in security and extends to the transferring of ownership for security purposes. See also Book IV "Of Preferences by Securities, Voluntary or Judicial over the Heritable Estate".

¹⁰⁴⁵ Bell, *Commentaries*, II, 11. There is a slight change from the 4th edition (1821) II, 16, in which Bell refers to such property being transferred "whether in sale or in security".

¹⁰⁴⁶ Bell, *Commentaries*, II, 16ff.

¹⁰⁴⁷ *Ibid*, II, 23.

¹⁰⁴⁸ *Ibid*, II, 23. He continues by stating that pledge is a "real right of detention merely, not of property".

¹⁰⁴⁹ *Ibid*, II, 23. Bell notes exceptions "when the debt is inseparable from the voucher, as in bills and notes".

that property assigned *ex facie* absolutely, but qualified by back letter, “still belonged to” the cedent;¹⁰⁵⁰ (ii) that the assignation of a claim in security was not “totally and absolutely” divestive, without regard to whether the secured debt had been paid;¹⁰⁵¹ (iii) that the effect of an assignation expressly in security “like that of any other conveyance in security, is not to divest the cedent absolutely, but merely to burden the cedent’s right, and thus... create a sort of hypothec...”;¹⁰⁵² (iv) that assignation expressly in security is non-divestive, confers “truly only a limited right” and can be equated with pledge and heritable security (presumably a bond and disposition in security).¹⁰⁵³

Each of these can, however, be criticised or interpreted in an alternative way. Taking them in turn: (i) may be viewed as the application of a superseded interpretation of the law of trusts, whereby the beneficiary owns the property;¹⁰⁵⁴ for (ii), the statement (by the Lord Ordinary) appears contrary to views expressed by the Lord Chancellor in the House of Lords, who considered the assignation to transfer the claim for payment, which meant that the debtors were only obliged to pay the assignee;¹⁰⁵⁵ for (iii), the statement is vague, the case involved special circumstances in the context of title to sue, and the First Division altered the Lord Ordinary’s interlocutor to require the assignee to join the action;¹⁰⁵⁶ and the reasoning of (iv) was based upon the historical mandatory (procuratory) interpretation of an assignation’s status,

¹⁰⁵⁰ *Monteith v Douglas and Leckie* (1710) Mor 10191.

¹⁰⁵¹ *Clyne* (1839) (n 1012), per Lord Ordinary’s Note at 34, and see 30f. See also *Robertson v Exley* (1832) 11 S 91, where an assignation in security was held not to preclude the cedent from pursuing, against the debtor, the recovery of sums beyond those required to satisfy the assignee. But it is notable that there was no objection from the assignee.

¹⁰⁵² *Fraser v Dunbar* (1839) 1 D 882 per Lord Ordinary’s Note at 884, and see his interlocutor at 884. Lord Fullerton (who was previously the Lord Ordinary) decided, along with his First Division colleagues, that his interlocutor should be altered to enable the assignee to join the cedent in the action and provided that the action could not proceed without the assignee joining. However, he stated that the decision was due to the “very special circumstances” of the case, and insisted that there was a “very material” difference between absolute conveyances and those “merely in security” (at 885).

¹⁰⁵³ *Forbes* (n 1010) per Lord Ordinary’s Note at 82ff. LJC Inglis (at 85) agreed with the Lord Ordinary’s interlocutor and the grounds of judgment outlined in the Note. And see per Lord Cowan at 87, who suggested the assignee only had the property for the special purpose of effecting a “limited security” and “to every other effect it belonged” to the cedent. See also *Gordon’s Creditors v Innes*, 15 January 1740, Kilkerran, 39, where a distinction was suggested between the effect of arrestment of debts in the hands of (i) a transferee; and (ii) “one who has a right in security”.

¹⁰⁵⁴ The Forbes report of the case refers to the assignation being in trust, except for the sum due to the assignee – (1710) Mor 10192f.

¹⁰⁵⁵ *Clyne* (1839) (n 1012) per LC Cottenham at 50f. This was despite the House of Lords affirming the interlocutors from the Court of Session.

¹⁰⁵⁶ See n 1052.

but this analysis has been convincingly challenged and certainly does not reflect the nature of modern assignation.¹⁰⁵⁷

Yet there are also insolvency cases which may undermine a full-divestiture analysis. In *Cleland Trustees v Dalrymple's Trustee*¹⁰⁵⁸ it was held that the bankrupt's whole estate vested in the trustee in sequestration and assignations expressly in security with intimation did not remove the property from the estate. The Lord President referred to the importance of the construction of s 102 of the Bankruptcy (Scotland) Act 1856, particularly the reference to the trustee's right being subject to "preferable securities".¹⁰⁵⁹ This analysis was supplemented by the Lord President's view of the "policy and effect" of the legislation, which was to vest the bankrupt's whole estate in the trustee and for the trustee to consider claims made. This would avoid the "great inconvenience and cost" that would arise if all questions of creditors' right and preferences had to be decided by the court.¹⁰⁶⁰

There is certainly a policy argument in favour of the trustee (or equivalent) adjudicating all claims against the insolvent party's estate. However, the key point is that where the insolvent party has been divested by assignation, their estate does not contain the assigned property. Under the 1856 Act, s 102, the moveable estate "so far as attachable for debt" was vested in the trustee.¹⁰⁶¹ But the bankrupt's property "attachable for debt" is the retrocession right to the assigned property. That is why arrestment in the hands of the *assignee* would be necessary (he is the debtor in the retrocession right), and intimation to that party would therefore also be required if the trustee sought to transfer the right vested in him.

¹⁰⁵⁷ See Anderson, *Assignation*, paras 5-13ff.

¹⁰⁵⁸ (1903) 6 F 262. Additional details about the case, and the arguments made, are available from the Session Papers, 1903-1904, vol 839, No 42. The case is referred to in Goudy, *Bankruptcy*, 4th edn by TA Fyfe (1914), 248, as authority for the proposition that creditors must make their claims to preferable ranking via the sequestration process.

¹⁰⁵⁹ Per LP Balfour at 267.

¹⁰⁶⁰ At 267f.

¹⁰⁶¹ In more recent legislative iterations the reference to attachability has been removed but the principle remains. In *Burnett's Tr*, at para 51, Lord Rodger states: "In my opinion the context in which the words 'the whole estate of the debtor' appear in the statute [the Bankruptcy (Scotland) Act 1985] shows that they must be given a meaning which gives effect to the rights which creditors are able to exercise against the debtor's property to secure payment of their debts." If claims assigned in security are subject to diligence by the cedent's creditors then those creditors should be able to arrest in the hands of the claim debtor. However, this does not seem to be possible.

The earlier Inner House cases of *Gordon v Millar*,¹⁰⁶² *Littlejohn v Black*¹⁰⁶³ and *Carter v McIntosh*¹⁰⁶⁴ were referred to and relied upon by the Lord President (and, previously, the Lord Ordinary) in *Cleland Trustees*.¹⁰⁶⁵ In *Gordon* and *Carter*, it seems to have been perceived that assignments in security were not fully divestive, and therefore property assigned in security would be part of the bankrupt's estate within the meaning of the relevant legislative provisions.¹⁰⁶⁶ The courts drew a distinction with absolute assignment, where the property would not fall into the estate due to ownership having transferred. It is not clear how assignment *ex facie* absolute would have been treated. But *Heritable Reversionary* could be used to support the view that if the "radical right" or "beneficial interest" actually remains with the cedent, then the assigned property will not fall into the estate of the bankrupt assignee. In this manner, *Heritable Reversionary*, which involved a disposition *ex facie* absolute, could be analogically extended to assignments *ex facie* absolute.

Littlejohn is a complicated and exceptional case featuring, *inter alia*, an *ex facie* absolute assignment of a reversionary interest in heritable property.¹⁰⁶⁷ A back bond revealed that the assignment was only in security. The trustee in sequestration was preferred over the whole fund at issue but only on the basis that preference was to be given to the assignees.¹⁰⁶⁸ However, this seems to have been a pragmatic solution given that the assignments were held for

¹⁰⁶² (1842) 4 D 352. The First Division considered that under the Bankruptcy (Scotland) Act 1839, s 78, the *universitas* of the bankrupt's moveable estate transferred to the trustee in sequestration, subject to preferable securities. The Session Papers (1841-1842, vol 369, No 76) reveal that as well as holding an arrestment, the creditor was claiming a preference by virtue of an assignment in security, albeit that there was a dispute regarding what precisely was assigned, and whether the assignment was intimated.

¹⁰⁶³ (1855) 18 D 207.

¹⁰⁶⁴ (1862) 24 D 925. Two claimants with assignments in security withdrew their claims, reserving their rights to claim in the sequestration.

¹⁰⁶⁵ N 1058.

¹⁰⁶⁶ Session Papers for *Gordon* (1841-1842, vol 369, No 76) show that the effect of assignment in security was the subject of argument and the trustee in sequestration contended that it differed from an absolute assignment as the former was only a preferable security under the statute, whereas the latter would mean the property would not vest in the trustee. The Inner House's decision appears to support this position. In *Carter*, the Lord Ordinary (see his Note at 930ff) gave consideration to *Gordon* and, in doing so, supplemented the "somewhat meagre" case report with reference to the Session Papers. On the basis of *Gordon*, the Lord Ordinary approved of the assignees in security withdrawing from the action, and reserving their rights to claim in the sequestration. He contrasted assignments in security, where the "radical right" remains with the cedent, with absolute assignments, which divest the bankrupt, and noted that the statute would not apply "if the ownership was not in the bankrupt". The Second Division in *Carter* appears to have approved of this: see per LJC Inglis at 933, who noted that if the remaining claimants were "merely creditors", like those who had withdrawn, then the sequestration would be the correct forum for determining priorities, but if they were (absolute) assignees then the property would not be subject to the sequestration.

¹⁰⁶⁷ For details beyond those provided in the case report, see Session Papers, 1855, vol 493, No 40.

¹⁰⁶⁸ N 1063 at 229 (interlocutor).

conditional cautionary obligations of a then-indeterminate amount, and there were contingencies arising from the application of the doctrine of catholic and secondary creditors.¹⁰⁶⁹ This, and some apparent support for a divestment view of assignation in the case,¹⁰⁷⁰ suggest its value as a source for a non-divestment thesis is highly qualified.

A party could, nevertheless, use the above authorities to support the argument that assignation in security, especially expressly in security, is not fully divestive and that property so assigned remains in the insolvent's estate. This might be seductive, if it were framed as necessary to give effect to the ranking provisions of s 464, which require attachment of the floating charge. It could also be contended that, in policy terms, a liquidator, receiver or administrator, like a trustee in sequestration, ought to manage the property and distribute based on ranking preferences, which would be a mechanism for giving the chargeholder priority. Yet such an approach would bring manifold problems and undermine contrary authority and the modern consensus.

(c) Judicial Authority Supporting Full Divestiture

There are a number of cases in which the court has considered or assumed that assignation in security involves full divestment and the assignation is treated like an absolute assignation. This includes the House of Lords case of *Redfearn v Sommervail*, which involved an assignation in security in breach of a latent trust, and where Lord Redesdale stated that an intimated assignation “denudes the assignor of all right in him to the thing assigned”.¹⁰⁷¹ In a later House of Lords case, *Hutchison, Main & Co*,¹⁰⁷² assignation in security was again perceived as being akin to any other assignation, there were references to assignation's divestment effect, and it was considered that a creditor had to hold a “jus in re” to have “an effectual security”.¹⁰⁷³ However, their Lordships' discussion of “beneficial interest” in property raises questions as to how they would have perceived the nature of a successfully created assignation in security in the case.¹⁰⁷⁴

¹⁰⁶⁹ Ibid per LP McNeill at 212f and 216f, and see the interlocutor at 229.

¹⁰⁷⁰ Ibid per Lord Ivory at 217. Lord Ivory considered that the effect of the assignation of the reversionary right was to “divest the bankrupt of every thing connected with the heritable subjects”. After the assignation, the bankrupt only held a right for the reversionary right to be retrocessed, upon satisfaction of the relevant secured debt.

¹⁰⁷¹ (1813) 5 Pat 707, HL per Lord Redesdale at 713f.

¹⁰⁷² N 610.

¹⁰⁷³ Ibid per Lord Kinneir at 4, Lord Atkinson at 10f and Lord Shaw of Dunfermline at 12ff.

¹⁰⁷⁴ Ibid eg per Lord Atkinson at 10f and Lord Shaw of Dunfermline at 15ff.

In *Whittall v Christie*¹⁰⁷⁵ the Inner House held that where an insurance policy was assigned in security the cedent's whole interest had been transferred and therefore an arrestment by creditors of the *cedent* in the hands of the insurance company (the claim debtor) was ineffectual. The arresters had sought to argue that the cedent's "large reversionary interest" in the property rendered the arrestment effective but this was rejected. The Lord Justice Clerk stated that the assignees in security "might be liable to account for any sum which was held to be part of the [cedent's] estate in a competent process"; however, the sum was "arrested in the hands of the [insurance] company, who have no right to pay it to anyone but the [assignees in security]".¹⁰⁷⁶

Although only an Outer House case, *Ayton v Romanes*¹⁰⁷⁷ is strong in principle. The cedent had granted an *ex facie* absolute assignation, actually in security, followed by two further assignations of his interest. He then entered sequestration. The court held that the first assignation transferred the right to the assignee, but with the obligation for that party to retrocess upon payment of the debt due. The subsequent assignations were of the reversionary right available after the satisfaction of the previous assignee(s). Therefore, the debtor of each reversionary right was the immediately preceding assignee.¹⁰⁷⁸ The Second Division case of *Nelson v National Bank*¹⁰⁷⁹ provides similar authority. In that case shares were assigned in security and the cedent held a reversionary right which it had also proceeded to assign in security, and this second assignation was intimated to the first assignee. The result was that the cedent then only had a further personal reversionary right exercisable against the second assignee. The latter party had a duty to protect the "ultimate reversionary right" of the pursuer and, in the circumstances of the case, had failed to do so.¹⁰⁸⁰

¹⁰⁷⁵ (1894) 22 R 91.

¹⁰⁷⁶ Ibid per Lord Justice-Clerk (MacDonald) at 94.

¹⁰⁷⁷ (1895) 3 SLT 203.

¹⁰⁷⁸ The case demonstrates that it is possible for there to be functional multiple ranking securities where property is assigned in security. Eg if A, B and C receive assignations of interest in property in turn, A receives the property, B gets a reversionary right against A, and C receives a reversionary right enforceable against B. Accretion will apparently operate when the property is returned to the cedent. (See Anderson, *Assignment*, paras 11-46ff, for discussion of accretion and assignation.) However, given that the rights of B and C are only personal until they receive the property, they stand to lose out if their debtor becomes insolvent in the meantime.

¹⁰⁷⁹ 1936 SC 570.

¹⁰⁸⁰ As they did not promptly demand a transfer of the property (shares) remaining after the discharge of the first assignee's claim: see eg per LJC Aitchison at 584f.

(d) Late-Nineteenth Century Commentary

Given the high status of the commentators Gloag and Irvine, Goudy, and Stewart, writing at the end of the nineteenth century, and the conflicting authority on assignation in security by this point, it is especially useful to consider their views. Gloag and Irvine appear to support the full-divestiture thesis by stating that the effect of assignation in security, upon intimation, is that “all right in the cedent is evacuated” with the assignee being “fully vested in the debt”.¹⁰⁸¹ Their treatment largely consists of analysing the general rules of assignation, with additional elements specific to assignation in security.¹⁰⁸² It is true that some of the language they use could cause confusion; for example, they refer to the cedent as the “real owner”, but they do so in the context of the assignee in security having a “personal obligation to restore [the property] to the real owner”.¹⁰⁸³ More problematic is the suggestion that assignations expressly in security do not give the assignee powers of disposal, in contrast to assignations *ex facie* absolute.¹⁰⁸⁴ And a direct comparison is drawn between the rights of debtor and creditor in an assignation *ex facie* absolute and an *ex facie* absolute disposition.¹⁰⁸⁵ The deemed equivalence between security over heritable property and security over incorporeal property may have also influenced their view of assignation expressly in security.¹⁰⁸⁶ Furthermore, they argue that diligence by creditors of the assignee is subject to the rights of the cedent, on the basis of the *tantum et tale* doctrine.¹⁰⁸⁷ This conclusion is, however, unlikely to meet favour in current law as the doctrine’s scope has been significantly curtailed.¹⁰⁸⁸

Goudy’s treatment of assignation in security is limited. He does, however, consider it to involve a transfer (in security) and distinguishes it from the real right of pledge.¹⁰⁸⁹ But when discussing the Bankruptcy (Scotland) Act 1856, he states that, on the basis of *Heritable Reversionary*, a trustee in sequestration of the creditor takes property held in security on an *ex*

¹⁰⁸¹ Gloag and Irvine, *Security*, 478. See also eg 440 and 469.

¹⁰⁸² See *ibid*, eg 490ff.

¹⁰⁸³ *Ibid*, 491.

¹⁰⁸⁴ See eg *ibid*, 492. They may have been influenced by cases such as *Forbes* (n 1010), which they cite, and in which, as we have seen, assignation expressly in security was viewed as something less than the transfer of ownership.

¹⁰⁸⁵ Gloag and Irvine, *Security*, 490 n 5, and see 151 and 163.

¹⁰⁸⁶ For the identification of such equivalence, see also WM Gloag, “Securities” in *Green’s Encyclopaedia of the Law of Scotland*, vol 11 (1899), 143ff; repeated in the second edition, vol 10, (1913), 621ff; and in Viscount Dunedin et al, *Encyclopaedia of the Law of Scotland*, vol 13, (1932), paras 790ff. And see Gloag, *Contract*, 640.

¹⁰⁸⁷ Gloag and Irvine, *Security*, 493f.

¹⁰⁸⁸ See *Burnett’s Tr*; Reid, *Property*, para 694; Anderson (n 820); and MacLeod (n 820), ch 8.

¹⁰⁸⁹ Goudy, *Bankruptcy*, 550ff.

facie absolute title “subject to the contract with the true and radical owner”.¹⁰⁹⁰ This is contrasted with cases where the bankrupt debtor holds a right of ownership¹⁰⁹¹ subject merely to a personal obligation, and the creditor then only has a right to rank personally on the sequestrated estate.¹⁰⁹² It appears that Goudy considered his view regarding *ex facie* absolute security within sequestration to apply across property law, and therefore it would also extend to a security in the form of an assignation *ex facie* absolute.¹⁰⁹³ Due to its overt status as a security, it is likely that Goudy perceived assignation expressly in security to have an even more limited effect in an insolvency context.¹⁰⁹⁴ Yet, given the current perceived divestive effect of assignation in security, it is likely that in present-day Scots law the assignee would be deemed to hold ownership encumbered only by a personal reversionary obligation. And the cedent’s trustee (or equivalent) would only have a right of retrocession.

It is difficult to discern Stewart’s views regarding the nature of assignation in security. He considers the extent to which the reversionary right arising from an assignation in security is attachable by arrestment and notes differences between assignation *ex facie* absolute and expressly in security.¹⁰⁹⁵ Stewart mentions the ability of the cedent’s creditors to arrest property in the hands of the assignee, in particular the balance beyond the amount secured by the assignation in security.¹⁰⁹⁶ This does not, however, imply that a creditor of the cedent can arrest the assigned property and that, consequently, an assignation does not fully divest the cedent. The fact that the arrestment is in the *assignee*’s hands indicates that the assignee is the debtor and that the arrested property is the cedent’s reversion right, rather than the assigned

¹⁰⁹⁰ Ibid, 265. However, see Gloag, “Securities” (1899) (n 1086), 160f, (and in (1913), 646f; and (1932), paras 844f) where it is stated that in considering whether secured property is part of a bankrupt estate “regard is to be had to the nominal title, rather than to the beneficial ownership”. (Cf Gloag and Irvine, *Security*, 152f, regarding the likely effect of *Heritable Reversionary*.)

¹⁰⁹¹ He uses the term “real beneficial right of ownership”.

¹⁰⁹² Goudy, *Bankruptcy*, 265; *Wylie v Duncan* (1803) Mor 10269; *Heritable Reversionary* per Lord McLaren in the Inner House ((1891) 18 R 1166 at 1173f) and Lord Watson in the House of Lords (at 46ff).

¹⁰⁹³ Goudy, *Bankruptcy*, 265.

¹⁰⁹⁴ Perhaps with the property remaining in the cedent’s estate but subject to the assignee’s security interest. Goudy, *Bankruptcy*, 265f, refers to the effect of vesting where there are preferable securities and distinguishes between those that create a “nexus” over the property in the bankrupt’s possession (eg arrestment and adjudication) and those which confer possession on the creditor (eg lien and pledge). Regarding the former, the trustee takes the “attached” property and gives preference to the creditor’s ranking preference, while in the latter, the trustee can only recover the property by paying the debt. It is not clear how he considers assignation expressly in security to fit in with this analysis, especially given the references to possession.

¹⁰⁹⁵ Stewart, *Diligence*, 151ff.

¹⁰⁹⁶ Ibid, 151 and 154.

property itself.¹⁰⁹⁷ This presupposes that the property assigned in security is transferred to the assignee, which is consistent with a divestiture thesis.

(e) Modern Position

By the early twentieth century then, the authorities were contradictory. But there was little additional case law or commentary to clarify the issues in the period up to the introduction of the floating charge in 1961. In the most contemporary edition of Gloag and Henderson's *Introduction to the Law of Scotland* published prior to 1961 it was simply stated that: "a debt of any kind... may be transferred in security by a written assignation, followed by intimation to the debtor".¹⁰⁹⁸ The year after the floating charge's arrival, TB Smith made an almost identical reference to assignation in security in his *Short Commentary*.¹⁰⁹⁹ In *Mercantile Law*, published a few years later, Gow suggests that an assignation in security involves transfer of "dominium", and discusses the legal basis for Gloag and Irvine's assertion that an assignee expressly in security does not have automatic powers of disposal.¹¹⁰⁰ As regards the latter, he rejects Gloag and Irvine's view, arguing instead that the issue is whether an assignee can give title to the property free from the cedent's "power of redemption".¹¹⁰¹ He seems to consider that the title of a party acquiring from an assignee *can* be qualified by the redemption power, but identifies problems with various underlying justifications for the rule, insofar as it applies to assignation *ex facie* absolute.¹¹⁰²

On the basis of the earlier authorities, it would have been possible for a more functionalist or non-divestive view of assignation in security in Scots law to have prevailed. Consideration of the South African position makes this apparent. In the midst of competing interpretations, the landmark case of *National Bank of South Africa v Cohen's Trustee*¹¹⁰³ determined that a cession *in securitatem debiti* is equivalent to a pledge and "dominium" remains with the

¹⁰⁹⁷ If, instead, the assigned property was being arrested then the arrestment would need to be in the hands of the claim debtor.

¹⁰⁹⁸ WM Gloag and RC Henderson, *Introduction to the Law of Scotland*, 6th edn by AD Gibb and NML Walker (1956), 195.

¹⁰⁹⁹ Smith, *Short Commentary*, 477.

¹¹⁰⁰ Gow, *Mercantile Law*, 284ff.

¹¹⁰¹ *Ibid*, 286.

¹¹⁰² The analysis is interesting but cannot be discussed in more detail here.

¹¹⁰³ 1911 AD 235.

cedent.¹¹⁰⁴ As well as doctrinal reasons for the decision, the court provided policy ones, which included that the trustee in bankruptcy should determine preferences and distribute, rather than the creditors having the powers to do so.¹¹⁰⁵ Ever since *Cohen's Tr*, there has been debate and disagreement in South African literature and case law as to whether the case was correctly decided and what the nature of cession in security is, including whether it is only a pledge or outright transfer or if both are available.¹¹⁰⁶ The uncertainty and controversy was, and is, notable. The current position is provided by the Supreme Court of Appeal case of *Grobler v Oosthuizen*,¹¹⁰⁷ where Brand JA (on behalf of the court) stated that, “primarily for pragmatic reasons”, the doctrinal debate had been “settled in favour of the pledge theory”.¹¹⁰⁸ However, although the pledge construction is the default position, dicta in *Grobler* suggest that parties could expressly create a *fiducia cum creditore* form of cession in security.¹¹⁰⁹ Yet there is still a lack of clarity as to when such a security will be recognised and there is doubt regarding the precise implications of the pledge construction.¹¹¹⁰

German law demonstrates an alternative course that Scots law could have adopted. The BGB expressly allows for the pledge of claims,¹¹¹¹ but such a pledge is only effective where notice is given to the claim debtor.¹¹¹² The deemed impracticality of this notice requirement (and other formalities) led the German courts to allow and develop the transfer of claims in security (*Sicherungsabtretung* or *Sicherungscession*).¹¹¹³ This form of security involves formal divestment but is dealt with under German legislation as a limited security right in insolvency law.¹¹¹⁴ Thus, in apparent contrast to modern Scots law, a transfer of a claim in security is

¹¹⁰⁴ For comparison of the Scots law and South African law, see P Nienaber and G Gretton, “Assignment/Cession” in R Zimmermann et al (eds), *Mixed Legal Systems in Comparative Perspective: Property and Obligations in Scotland and South Africa* (2005), 814ff.

¹¹⁰⁵ Per De Villiers CJ at 248. This is similar to the reasoning in *Cleland's Trs*: see above.

¹¹⁰⁶ For a summary of this, see S Scott, “One Hundred Years of Security Cession” 2013 SA Mercantile Law Journal 513. See also the discussion in *Grobler v Oosthuizen* (2009) (5) SA 500 (SCA), especially per Brand JA at paras 15ff.

¹¹⁰⁷ N 1106.

¹¹⁰⁸ Per Brand JA at para 17.

¹¹⁰⁹ Per Brand JA at para 23f.

¹¹¹⁰ See eg Scott (n 1106) at 530ff.

¹¹¹¹ BGB §1279 “Pfandrecht an einer Forderung”.

¹¹¹² BGB §1280.

¹¹¹³ BGB §398, which allows for the transfer of claims by contract, and without publicity, is the doctrinal basis for the institution. There is also an equivalent for corporeal moveables: BGB §1205 requires delivery to create a pledge over such property but transfer of ownership as a security (*Sicherungsübereignung*) has been accepted (using BGB §929 and §930 as the legal basis). Security transfers were recognised before, and then a short time after, the introduction of the BGB in 1900 (see the cases cited by M Brinkmann, “The Peculiar Approach of German Law in the Field of Secured Transactions and Why It Has Worked (So Far)” in *Secured Transactions Law Reform*, 341).

¹¹¹⁴ See InsO §51 and §166(2).

treated in German law as an *Absonderungsrecht* rather than an *Aussonderungsrecht*.¹¹¹⁵ The German position is doctrinally questionable, as a strict reading of the BGB precludes security over claims otherwise than by pledge. It is interesting to note that the German legal position, including criticisms of the absence of publicity, was communicated to the LRCS during its law reform project by Ernst von Caemmerer, a consulted expert.¹¹¹⁶ Despite its dubious doctrinal foundations and lack of publicity, the present legal position is widely accepted in Germany as it is considered to provide a pragmatic and commercial result.¹¹¹⁷

Returning to Scots law, the absence of authority since the early twentieth century has facilitated the success of a formalist vision that is simpler and more doctrinally anchored than the German and South African approaches. Reliance on previously used equitable concepts such as “radical rights” and “beneficial interest”, to determine the nature of assignation in security, would be fraught with difficulty.¹¹¹⁸ As Professor Gretton writes regarding radical rights more widely: “the doctrine is on the whole a bad one. It is often obscure, often incoherent. It does not harmonise with the generality of property law.”¹¹¹⁹ Perhaps most notably, it is contrary to Scots property law’s clear delineation between personal rights and a (largely) fixed list of real rights. As Lord Hope states in *Burnett’s Tr*, Scots law “does not recognise” a right between a personal right and a real right, and this notion is at the “very centre of the law relating to rights in security, the law of diligence and the law of bankruptcy”.¹¹²⁰ And it should also be at the heart of corporate insolvency law.

The fully divesting nature of assignation in security has been recognised in the floating charges context. In *Forth & Clyde* it was held that a floating charge attached as if it were an intimated assignation in security in favour of the chargeholder and, because of the deemed divesting effect, creditors of the (cedent) company could no longer arrest the attached property.¹¹²¹ But Lord President Hope seems to have presented an alternative view in *Iona Hotels*, another

¹¹¹⁵ See n 1029 above. See also Brinkmann “German Secured Transactions” (n 1113), 341f.

¹¹¹⁶ See NRS AD61/55 – letter from E von Caemmerer, Freiburg University, to TB Smith, Edinburgh University, dated 17 December 1958 (trans by I Vair-Turnbull, Foreign Office). See also ADJ MacPherson, “TB Smith and Max Rheinstein: Letters from America” (2016) 20 EdinLR 42 at 54f. And see TB Smith’s comments on German law in *Eighth Report*, 13f.

¹¹¹⁷ Brinkmann “German Secured Transactions” (n 1113), 343ff.

¹¹¹⁸ The cases in which such terminology is used reflect a period of heavy English influence on Scots law.

¹¹¹⁹ Gretton, “Radical Rights”, 56.

¹¹²⁰ At para 19. Also see Bell, *Commentaries*, I, 279.

¹¹²¹ *Forth & Clyde* per LP Emslie at 10-12. But the effect of the statutory hypothesis meant that the property itself remained with the company, unlike in a “normal” assignation in security. And see *Myles J Callaghan* (n 355) per Lord Ordinary (Prosser) at 181.

floating charges case. He stated that “property which is the subject of an assignation in security *remains the property of the company* subject to the rights of the assignee”.¹¹²² This appears to reflect a non-divestment perspective.

To overturn the modern consensus interpretation would be highly problematic. A subordinate right view is inconsistent with the existence of a retrocession right, which indicates divestment has taken place (as otherwise no re-transfer would be necessary).¹¹²³ And an assignee can apparently transfer the property to a third party.¹¹²⁴ If the assignee only held a limited right, it would only be able to transfer that right, not the property itself. A further difficulty is that if the property is the right to receive payment from a debtor, it will not be clear to that party when the cedent’s debt to the assignee is fulfilled and therefore when the debtor should instead pay the cedent. Intimation following retrocession therefore appears necessary.

A non-divesting interpretation would raise many questions about the precise nature of the security interest: how it differs in practical and theoretical terms from absolute assignation, what the lesser right of assignation in security is a right to, whether an assignation *ex facie* absolute qualified by back letter has a different nature from assignation expressly in security, and so on. South Africa, a larger jurisdiction with a greater volume of legal commentary and case law, has struggled to answer many of these questions and serves as a somewhat cautionary tale. To re-direct Scots law in this area simply to enable floating charges to attach would be deeply regrettable. A general real security right in incorporeal property could be facilitated in Scots law, and might even be desirable, but such a change would be most appropriate through legislative reform, after much consideration and analysis.

(2) Trust

If an assignee holds assigned property, or proceeds, in trust for the cedent (the beneficiary), then the property is protected from the assignee’s insolvency. And if the cedent became insolvent, its personal rights in relation to the trust patrimony would be included within its own insolvent estate. There is some precedent in Scots law that an assignee in security holds

¹¹²² *Iona Hotels* per LP Hope at 336. Emphasis added.

¹¹²³ Rather than the assignee’s right simply being extinguished upon satisfaction of the underlying debt obligation of the cedent. For extinction of a security right more generally, see Steven (n 88).

¹¹²⁴ The offside goals rule might cause a subsequent acquirer in bad faith, or a donee, to be bound by the retrocession right, but this is consistent with the retrocession right being a personal right.

surplus property and proceeds in trust on behalf of the cedent. *Purnell v Shannon*¹¹²⁵ revolved around the question of whether an assignee was required to retransfer assigned property to the cedent after satisfaction of a debt. The First Division held that the assignation was *ex facie* absolute and that any “understanding” that it was actually in security was an averment of trust, which was not proved in the circumstances of the case. This has been interpreted by Professor Gretton to mean that assignation *ex facie* absolute creates a trust, with the assignee holding trust property partly for its own benefit and partly for the cedent’s benefit.¹¹²⁶ The decision can certainly be read in this way, but there is little detail to the statements in *Purnell* regarding trusts. And the relevant dicta do not necessarily exclude the possibility that creating a trust is an alternative to an assignation in security proper.¹¹²⁷ The particular wording of the assignation in security or back letter could be crucial. It is also unclear whether any trust would be a constructive trust, due to the nature of the security relationship, or if the transaction would be deemed to create an implied trust reflecting the intention of the parties. Whatever the nature of such a trust, if one is created by assignation *ex facie* absolute qualified by back letter, there is an even stronger case for its creation by an assignation expressly in security.

In any event, the possible trust mentioned above may not enable the chargeholder to rank ahead of the assignee in security. It would apparently only allow the chargeholder to have an insolvency-proof priority right to the surplus property or proceeds, through the cedent’s rights as beneficiary. Instead, for the chargeholder to realise a ranking preference over the assignee, all of the property, or at least enough of it to satisfy the chargeholder’s claim, would need to be held in trust, for the benefit of the cedent (or chargeholder). This would need to be the case from the point at which the charge attaches. Before that time, the assignee could be entitled to the property and any proceeds obtained. But, at any given point, how would the assignee know the amount of the chargeholder’s claim and whether or not the assigned property would be needed to satisfy it?¹¹²⁸ The absence of publicity to the assignee (and the claim debtor) upon attachment also militates against such an analysis. In addition, if the assignee was required to transfer property to a liquidator, receiver or administrator, he could lose any ranking preference (whether lower or higher than a chargeholder), as his basis for a priority right to the property would disappear with the transfer. Beyond these difficulties, the imposition of a

¹¹²⁵ N 1042.

¹¹²⁶ Gretton, “Radical Rights”, 201 n 32; Nienaber and Gretton, “Assignment/Cession” (n 1104), 815.

¹¹²⁷ See eg *Monteith* (n 1050) for an apparent example of assigned property being held in trust (rather than formally in security).

¹¹²⁸ Or if other property subject to the charge would be sufficient.

trust would be highly artificial and the extent of the trust necessary to enable a chargeholder to have priority is without support in existing authorities.

(3) Grant in Breach of Negative Pledge is Non-Divestive?

Another possibility is that even if an assignation in security is ordinarily fully divestive, there is a specific exception to this where the assignation is in competition with a prior-ranking floating charge. The operation and effect of a negative pledge clause could provide this effect. However, this has become more difficult to contend given the statutory provision which states that the effect of a negative pledge is to “confer priority on the floating charge over any fixed security or floating charge created after the date of the instrument”.¹¹²⁹ The simplest meaning is that this refers to a ranking priority where the charge attaches, and is inapplicable as regards property no longer belonging to the company, such as property assigned in security. But, if “confer priority” is interpreted widely, it could mean that an assignation in security in breach of the negative pledge is ineffective in any competition with a chargeholder, or is challengeable by a chargeholder,¹¹³⁰ as priority can only be given to the chargeholder in this way. Yet, given that the charge is enforced through liquidation, receivership or administration, the assignation in security would also apparently need to fall within the chargor cedent’s estate in these processes to enable the insolvency practitioner to deal with the property.

To suggest that an assignation in security in breach of a negative pledge has such an effect would be rather awkward in theory and practice. It represents a considerable extension of the currently accepted ranking effect of s 464(1A). And it is contrary to: (i) the continued ability of an assignee to transfer the property; (ii) the property’s susceptibility to the diligence of the assignee’s creditors; and (iii) the fact that the property would be deemed to be within the assignee’s insolvent estate. Given that the assignee apparently owns the property, there is also a policy argument against penalising parties acquiring interest through the assignee in good faith. There could, however, be exceptions giving effect to the negative pledge against these parties if they have notice of it, but formulating appropriate rules would be a challenge. And if the property is a claim, the debtor will have been informed to make payment to the assignee, again supporting the notion that the assignation ought to be effective.

¹¹²⁹ 1985 Act, s 464(1A).

¹¹³⁰ See *Halliday’s Conveyancing*, vol 2, para 56-23, who refers to the prohibition in a negative pledge enabling the chargeholder to “challenge” any subsequent fixed security or floating charge created in breach of the negative pledge.

It would be more straightforward if: (i) an assignation is only rendered ineffective from the attachment of the charge (or from when the assignee has notice of this); (ii) the assignee has powers to deal with the property before attachment; and (iii) the ineffectiveness does not affect successors of the assignee (voluntary and involuntary). But this means that if A Ltd transfers incorporeal property to C Ltd, the latter could grant security over the property, including a floating charge to D Bank. If D Bank's charge attached before, or even after, B Bank's charge, would D Bank be defeated by an automatic (deemed) reversion of the property to A Ltd, upon B Bank's charge attaching? And what would be the liabilities and entitlements if the debtor made a (further) payment to C Ltd? If the two charges were in competition, there is no clear answer as to how enforcement would precisely work or which charge would have priority. Would they rank according to first registration or creation? If either of these applies, D Bank could lose out even if not blameworthy. For instance, if C Ltd's charge to D Bank was created later than B Bank's charge from A Ltd, there would be no indication on the charges register for C Ltd that its property was subject to B Bank's charge. Rather, B Bank's charge is shown on A Ltd's entry. This highlights a particular difficulty in Scots law where a company transfers property in security, as the security is registered against the transferee, not the transferor (nor against the property itself). Due to all of the above, it is clear that there would be much to resolve with an approach dependent upon the negative pledge rendering an assignation in security ineffective.

(4) *Sharp v Thomson*

A further solution is provided by a wide reading of *Sharp*. But this is only true if the ratio applies to incorporeal property *and* if property not owned by the company can still be within its property and undertaking. The latter requires that *Sharp's* ratio involves a full equitable attachment approach.¹¹³¹ If property is assigned in security and "beneficial interest" remains with the cedent, the property could still be attached by a charge granted by the cedent.

But, as has been noted elsewhere, there are considerable problems with the full equitable attachment approach. Within the context of assignation in security, these are particularly apparent. The debtor in a claim has been ordered to make payment to the assignee, by the intimation, but the cedent is considered to have the beneficial interest. What mechanism would

¹¹³¹ See 93ff.

there be for the cedent's liquidator or equivalent to obtain the property or proceeds from the assignee or the debtor? And if the assignee transfers the property to a further party before or after the attachment of the charge, does the property remain in the original cedent's property and undertaking? If so, how is the charge enforced against successor parties? Again, there are a multitude of questions casting doubt upon the validity and appeal of the option.

(5) Non-Attachment

Given the complexity involved in the above solutions, a simple alternative is attractive. The most obvious is for a charge not to attach to property assigned in security. Property transferred by the chargor is no longer attachable by a chargor-granted floating charge, and treating assignation in security in the same way as the wider law is coherent. If assignation in security is not a fixed security, then there is no inherent contradiction with the ranking provisions. Even if it is, the floating charge cannot compete with it due to the absence of attachment, which is a pre-requisite for ranking. (In other words, the charge must be in the race before we can determine what place it finishes in.) The charge would, however, attach to the chargor's personal right of reversion and could attach to the property itself if it were retrocessed.

It might be argued that if the previous paragraph is correct, parties would use assignation in security as a way to defeat a pre-existing floating charge. However, the charge would attach to loan sums received from the assignee and, if the sum paid was of lower value than the assigned property, the assignee may not ultimately benefit, as the transaction could be challengeable. In addition, there are already various ways in which a floating charge can be defeated: by absolute assignments, eg in debt factoring; by transfers of corporeal property; and by retention of title.

(6) Legislation

The current uncertainty as to the law in this area means that a legislative solution would be welcome. Such a solution could come in a number of forms. The most complicated and significant change to resolve the matter would be to introduce a subordinate security right for incorporeal property and to prohibit assignation in security (similar to the position for

(corporeal) heritable property). The SLC intend to introduce a new subordinate real right in security but it will not replace assignation in security.¹¹³²

A simpler amendment would be to provide that if a floating charge ranks ahead of an assignation in security, the charge attaches to the property, despite the earlier divestment, and the assignee is obliged, upon attachment of the charge, to transfer the property back to the company for realisation and distribution. The assignee's priority interest could also be expressly protected despite the re-transfer. A number of issues, such as when the assignee has notice of the attachment, whether the property could fall into the assignee's insolvency and how much protection third party acquirers from the assignee should be given, would all require careful consideration.

¹¹³² See SLC, *Moveable Transactions*, especially paras 3.12 and 3.21.

CHAPTER 10

CONCLUSION

This thesis has shown that the floating charge can be interpreted in a way that is more coherent with Scots property law and insolvency law. The floating charge is anomalous in our system, but that does not mean it cannot be better integrated and synthesised with the background law. The charge's patrimonial nature has been repeatedly emphasised in the present thesis. Perhaps most significantly in this respect, enforcement of the charge, even after attachment, appears limited to property within the chargor's patrimony at any given time. A liquidator, administrator or receiver acts as an agent of the *chargor* as regards that party's property. Given that a chargeholder relies on these parties for enforcement, if property validly leaves the chargor's (private) patrimony, either before or after attachment, then it seems that such property can no longer be affected by the charge.

The floating charge's true nature is, however, elusive. Before attachment, it is difficult to contend that it is a real right. At that time, the charge confers only a conditional real interest and no direct powers over the property; only powers to replace the management of the chargor and to bring about attachment. Upon attachment, the charge has some real effect: particular property is affected and used for realisation to pay the chargeholder, and the charge has a ranking priority against certain real security rights. But other features such as the non-availability of direct enforcement by a chargeholder and patrimonial limitations suggest it could be a *sui generis* right combining elements of a real right and insolvency preference.

There are a number of ways in which the floating charge does not accord with the principles of Scots property law, such as its limited compliance with the publicity principle. In certain respects, this has become worse over time; the removal of registration as a necessary condition for a floating charge to rank ahead of a subsequent fixed security, without comment, remains objectionable. Overall, remedying the publicity deficit as regards the charge's creation and attachment would be highly desirable, from a doctrinal perspective.

Yet this thesis has shown that uncertainty and obscurity in areas of law interacting with the charge also contribute to difficulties integrating the floating charge into wider Scots law. This was true for the old *ex facie* absolute disposition qualified by back letter and arguably remains so for the assignation in security of incorporeal property. The eventual success of divestiture analyses for each of these, means it is unclear whether, and how, a floating charge could attach to property subject to such forms of security. Matters of this type could have been given greater attention by the LRCS and the legislature when the charge was introduced or by those involved in subsequent floating charge legislation. However, resolving the problems would be difficult without more expansive reform dealing with the law beyond floating charges.

The judiciary have also often struggled to appropriately deal with the floating charge. This is exemplified by *Sharp*. The case, and related commentary, show that there was existing debate and conflicting sources regarding when (heritable) “property” transfers in Scots law. But the opinions in *Sharp* are flawed and depend upon a functionalist view of property in its interaction with the floating charge. There is now a divergence between the charge’s attachment and property law generally, as in the latter a formalist interpretation has prevailed. *Sharp* therefore perpetuates the status of the charge as an “alien” concept and its ratio should be confined as narrowly as possible. Instead, an approach to attachment focused on whether the chargor owns the property would be much simpler and in conformity with property law. When paired with patrimonial limitations on the charge’s enforcement, it would also somewhat address the policy concerns that underlay the decision in *Sharp*.

Interpreting the charge in a way that fits with the rest of the law does not mean that it necessarily loses its status as an exceptional institution. Indeed, it seems that the currently prevailing view of the statutory hypothesis for attachment’s effect is incorrect. The charge does not need to take on the characteristics of existing securities to function effectively. Rather, it is more appropriate for the charge to be considered a *sui generis* security upon attachment that was intended to correspond with the general concept of a fixed security, which is a security effective over property in the company’s winding up.

The floating charge arrived in Scots law, as a modified transplant from English equity, prior to the renaissance of Scots property law in recent decades. If a security over fluctuating property was to be introduced now, its commercial purposes would undoubtedly be met in a

way that works better with the present state of private law. Nevertheless, this thesis has demonstrated that, in certain respects, even the floating charge can be interpreted as being a doctrinally palatable institution. Approaching attachment issues in the manner outlined in this thesis is advisable and will remain important for as long as the charge exists in Scots law. The current calls for the reform of secured transactions in English law, which could lead to the abolition of the English floating charge,¹¹³³ may raise questions about the future of the Scottish equivalent. However, whatever course reform takes in England, the Scottish floating charge will be with us for some time yet. And even if a new security was to ultimately replace the floating charge, the story of the latter in Scots law would be highly instructive for the introduction and development of the new form of security.

¹¹³³ Differing visions of reform have been proposed, most notably by the City of London Law Society and the Secured Transactions Law Reform Project: see Sheehan, *Personal Property Law* (n 19), ch 15.

Bibliography

Books

C Anderson, *Possession of Corporeal Moveables* (2015)

RG Anderson, *Assignment* (2008)

JF Baur and R Stürner, *Sachenrecht*, 18th edn (2009)

H Beale, M Bridge, L Gullifer and E Lomnicka, *The Law of Security and Title-Based Financing*, 2nd edn (2012)

AM Bell, *Lectures on Conveyancing*, 3rd edn (1882)

GJ Bell, *Commentaries on the Laws of Scotland and on the Principles of Mercantile Jurisprudence*, 4th edn (1821) 2 vols

GJ Bell, *Commentaries on the Laws of Scotland and on the Principles of Mercantile Jurisprudence*, 5th edn (1826) 2 vols

GJ Bell, *Principles of the Law of Scotland*, 4th edn (1839) [reprinted 2010]

DA Bennett, *Palmer's Company Insolvency in Scotland* (1993)

FAR Bennion, *Understanding Common Law Legislation: Drafting and Interpretation* (2001)

DA Brand, AJM Steven and S Wortley, *Professor McDonald's Conveyancing Manual*, 7th edn (2004)

MP Brown, *A Treatise on the Law of Sale* (1821)

R Brown, *Treatise on the Sale of Goods with Special Reference to the Law of Scotland*, 2nd edn (1911)

R Calnan, *Proprietary Rights and Insolvency* (2010)

R Calnan, *Taking Security*, 3rd edn (2013)

D Carey Miller (with D Irvine), *Corporeal Moveables in Scots Law*, 2nd edn (2005)

J Craigie, *Scottish Law of Conveyancing: Moveable Rights*, 2nd edn (1894)

DJ Cusine (ed), *Green's Practice Styles* (Looseleaf) (1995-)

J Dalrymple, Viscount Stair, *The Institutions of the Law of Scotland* (DM Walker (ed) (1981))

J Erskine of Carnock, *An Institute of the Law of Scotland*, 1st edn (1773) [reprinted 2014]

WCH Irvine, *Consumer Law in Scotland*, 5th edn (2015)

W Faber and B Lurger (eds), *National Reports on the Transfer of Movables in Europe* (2008-2009) 6 vols

IM Fletcher and R Roxburgh, *Greene and Fletcher, The Law and Practice of Receivership in Scotland*, 3rd edn (2005)

S Frisby and M Davis-White (eds), *Kerr and Hunter on Receivers and Administrators*, 19th edn (2010)

SD Girvin, S Frisby and A Hudson, *Charlesworth's Company Law*, 18th edn (2010)

WM Gloag, *The Law of Contract: A Treatise on the Principles of Contract in the Law of Scotland*, 2nd edn (1929)

WM Gloag and RC Henderson, *Introduction to the Law of Scotland*, 6th edn by AD Gibb and NML Walker (1956)

WM Gloag and RC Henderson, *The Law of Scotland*, 13th edn by Lord Eassie and HL MacQueen (2012)

WM Gloag and JM Irvine, *Law of Rights in Security: Heritable and Moveable Including Cautionary Obligations* (1897)

RM Goode, *Principles of Corporate Insolvency Law*, 3rd edn (2005)

RM Goode, *Principles of Corporate Insolvency Law*, 4th edn (2011)

WM Gordon, *Scottish Land Law*, 2nd edn (1999)

H Goudy, *A Treatise on the Law of Bankruptcy in Scotland*, 2nd edn (1895)

H Goudy, *A Treatise on the Law of Bankruptcy in Scotland*, 4th edn by TA Fyfe (1914)

WJ Gough, *Company Charges*, 2nd edn (1996)

- JJ Gow, *The Law of Hire-Purchase in Scotland*, 2nd edn (1968)
- JJ Gow, *The Mercantile and Industrial Law of Scotland* (1964)
- LCB Gower, *The Principles of Modern Company Law*, 2nd edn (1957)
- GL Gretton, *The Law of Inhibition and Adjudication*, 2nd edn (1996)
- GL Gretton and AJM Steven, *Property, Trusts and Succession*, 2nd edn (2013)
- GL Gretton and KGC Reid, *Conveyancing*, 2nd edn (1999)
- GL Gretton and KGC Reid, *Conveyancing*, 4th edn (2011)
- L Gullifer (ed), *Goode on Legal Problems of Credit and Security*, 4th edn (2008)
- L Gullifer (ed), *Goode on Legal Problems of Credit and Security*, 5th edn (2013)
- L Gullifer and O Akseli, *Secured Transactions Law Reform: Principles, Policies and Practice* (2016)
- JM Halliday, *The Conveyancing and Feudal Reform (Scotland) Act 1970*, 2nd edn (1977)
- M Higgins, *The Enforcement of Heritable Securities*, 2nd edn (2016)
- O Jones, *Bennion on Statutory Interpretation: A Code*, 6th edn (2013)
- A Keay and P Walton, *Insolvency Law: Corporate and Personal*, 3rd edn (2012)
- G Lightman and GS Moss, *The Law of Administrators and Receivers of Companies*, 5th edn (2011)
- Lord Lindley, *A Treatise on the Law of Companies*, 6th edn by WB Lindley (1902)
- A McAllister, *Scottish Law of Leases*, 4th edn (2013)
- WW McBryde, *Bankruptcy*, 2nd edn (1995)
- WW McBryde, *The Law of Contract in Scotland*, 3rd edn (2007)
- A McDouall, Lord Bankton, *An Institute of the Law of Scotland in Civil Rights* (1751-53) [reprinted 1993-95]
- E McKendrick, *Goode on Commercial Law*, 5th edn (2016)

DW McKenzie Skene, *Insolvency Law in Scotland* (1999)

S Mills, N Ruddy and N Davidson, *Salinger on Factoring*, 5th edn (2017)

RJ Mokal, *Corporate Insolvency Law: Theory and Application* (2005)

G Morse (ed), *Palmer's Company Law*, 25th edn (Looseleaf) (1992-)

RRM Paisley, *Land Law* (2000)

FB Palmer, *Company Law* (1898)

A Paterson, *Final Judgment: The Last Law Lords and the Supreme Court* (2013)

GCH Paton and JGS Cameron, *The Law of Landlord and Tenant in Scotland* (1967)

L Payette, *Les Sûretés Réelles dans le Code Civil du Québec*, 2nd edn (2001)

KGC Reid (with GL Gretton, AGM Duncan, WM Gordon and AJ Gamble), *The Law of Property in Scotland* (1996)

KGC Reid and GL Gretton, *Land Registration* (2017)

KGC Reid and R Zimmermann (eds), *A History of Private Law in Scotland* (2000) 2 vols

R Rennie (with M Blair, S Brymer, F McCarthy and T Mullen), *Leases* (2015)

N Ruddy, S Mills and N Davidson, *Salinger on Factoring*, 4th edn (2006)

CM Schmitthoff and TPE Curry, *Palmer's Company Law*, 20th edn (1959)

D Sheehan, *The Principles of Personal Property Law*, 2nd edn (2017)

TB Smith, *Property Problems in Sale* (1978)

TB Smith, *A Short Commentary on the Law of Scotland* (1962)

J St Clair and J Drummond Young, *The Law of Corporate Insolvency in Scotland*, 2nd edn (1992)

J St Clair and J Drummond Young, *The Law of Corporate Insolvency in Scotland*, 4th edn (2011)

AJM Steven, *Pledge and Lien* (2008)

- JG Stewart, *A Treatise on the Law of Diligence* (1898)
- IJS Talman (ed), *Halliday's Conveyancing Law and Practice in Scotland*, 2nd edn (1996-1997)
2 vols
- L van Vliet, *Transfer of Movables in German, French, English and Dutch Law* (2000)
- A von Tuhr, *Der Allgemeiner Teil des Deutschen Bürgerlichen Rechts* (1910) [reprinted 1997], 2 vols
- G Watson, *Bell's Dictionary and Digest of the Law of Scotland*, 7th edn (1890) [reprinted 2012]
- S Wheeler, *Reservation of Title Clauses: Impact and Implications* (1991)
- WA Wilson, *The Law of Scotland Relating to Debt* (1982)
- WA Wilson, *The Scottish Law of Debt*, 2nd edn (1991)
- GW Wilton, *Company Law and Practice in Scotland* (1912)
- M Wolf and J Neuner, *Allgemeiner Teil des Bürgerlichen Rechts*, 11th edn (2016)
- S Worthington, *Proprietary Interests in Commercial Transactions* (1996)
- Lord Wrenbury, *Buckley on the Companies Acts*, 13th edn by JB Lindon (1957)

Chapters from Edited Books

- DA Bennett, "Companies" in *The Laws of Scotland: Stair Memorial Encyclopaedia*, Reissue (2013)
- DA Bennett, "The Receiver in Scotland" in S Frisby and M Davis-White (eds), *Kerr and Hunter on Receivers and Administrators*, 19th edn (2010)
- M Brinkmann, "The Peculiar Approach of German Law in the Field of Secured Transactions and Why It Has Worked (So Far)" in L Gullifer and O Akseli (eds), *Secured Transactions Law Reform: Principles, Policies and Practice* (2016)
- J Burgoyne, "Heritable Securities" in *The Laws of Scotland: Stair Memorial Encyclopedia*, vol 20 (1992)

DL Carey Miller, MM Combe, AJM Steven and S Wortley, “National Report on the Transfer of Movables in Scotland” in W Faber and B Lurger (eds), *National Reports on the Transfer of Movables in Europe*, vol 2 (2009)

D Faber and N Vermunt, “National Report for the Netherlands” in D Faber, N Vermunt, J Kilborn, T Richter and I Tirado (eds), *Ranking and Priority of Creditors* (2016)

WM Gloag, “Securities” in *Green’s Encyclopaedia of the Law of Scotland*, vol 11 (1899)

WM Gloag, “Securities” in *Green’s Encyclopaedia of the Law of Scotland*, 2nd edn, vol 10 (1913)

WM Gloag, “Securities” in *Encyclopaedia of the Laws of Scotland*, vol 13 (1932)

G Gretton, “Up there in the *Begriffshimmel*?” in L Smith (ed), *The Worlds of the Trust* (2013)

GL Gretton, “Diligence and Enforcement of Judgments” in *The Laws of Scotland: Stair Memorial Encyclopedia*, vol 8 (1992)

GL Gretton, “Ships as a Branch of Property Law” in ARC Simpson, SC Styles, E West and ALM Wilson (eds), *Continuity, Change and Pragmatism in the Law: Essays in Memory of Professor Angelo Forte* (2016)

GL Gretton, “The Concept of Security” in DJ Cusine (ed), *A Scots Conveyancing Miscellany: Essays in Honour of Professor JM Halliday* (1987)

GL Gretton, “The Rational and the National” in EC Reid, D Carey Miller (eds), *A Mixed Legal System in Transition: TB Smith and the Progress of Scots Law* (2005)

GL Gretton, “Trust and Patrimony” in HL MacQueen (ed), *Scots Law into the 21st Century: Essays in Honour of WA Wilson* (1996)

RB Jack, “The Coming of the Floating Charge to Scotland: An Account and an Assessment” in DJ Cusine (ed), *A Scots Conveyancing Miscellany: Essays in Honour of Professor JM Halliday* (1987)

J MacLeod, “Non-Judicial Real Security” in IG MacNeil (ed), *Scots Commercial Law* (2014)

J MacLeod, “The Offside Goals Rule and Fraud on Creditors” in F McCarthy, J Chalmers and S Bogle (eds), *Essays in Conveyancing and Property Law in Honour of Professor Robert Rennie* (2015)

M-R McGuire, “National Report on the Transfer of Movables in Germany” in W Faber and B Lurger (eds), *National Reports on the Transfer of Movables in Europe*, vol 3 (2011)

DW McKenzie Skene, “Corporate Insolvency” in *The Laws of Scotland: Stair Memorial Encyclopedia*, Reissue (2008)

P Nienaber and G Gretton, “Assignment/Cession” in R Zimmermann, D Visser and K Reid (eds), *Mixed Legal Systems in Comparative Perspective: Property and Obligations in Scotland and South Africa* (2004)

CG Paulus and M Berberich, “National Report for Germany” in D Faber, N Vermunt, J Kilborn, T Richter and I Tirado (eds), *Ranking and Priority of Creditors* (2016)

AJ Sim, “Rights in Security over Moveables” in *The Laws of Scotland: Stair Memorial Encyclopedia*, vol 20 (1992)

AJM Steven, “Rights in Security over Moveables” in K Reid and R Zimmermann, *A History of Private Law in Scotland*, vol 1 (2000)

AJM Steven and H Patrick, “Reforming the Law of Secured Transactions in Scotland” in L Gullifer and O Akseli (eds), *Secured Transactions Law Reform: Principles, Policies and Practice* (2016)

SC Styles, “Rights in Security” in ADM Forte (ed), *Scots Commercial Law* (1997)

JF Wallace, “Interpretation of Statutes” in *The Laws of Scotland: Stair Memorial Encyclopedia*, vol 12 (1992)

RB Wood, “Leasing and Hire of Moveables” in *The Laws of Scotland: Stair Memorial Encyclopaedia*, Reissue (2001)

RB Wood, “Special Considerations for Scotland” in *Salinger on Factoring*, 4th edn by N Ruddy, S Mills and N Davidson (2006)

RB Wood, “Special Considerations for Scotland” in *Salinger on Factoring*, 5th edn by S Mills, N Ruddy and N Davidson (2017)

PhD Theses

J MacLeod, "Fraud and Voidable Transfer: Scots Law in European Context" (PhD Thesis, University of Edinburgh) (2013)

R Rennie, "Floating Charges: A Treatise from the Standpoint of Scots Law" (PhD Thesis, University of Glasgow) (1972)

Articles

K Akintola, "What is Left of the Floating Charge? An Empirical Outlook" (2015) 7 JIBFL 404

RG Anderson, "Fraud on Transfer and on Insolvency: *Ta...Ta...Tantum et Tale*" (2007) 11 EdinLR 187

RG Anderson and J Biemans, "Reform of Assignation in Security: Lessons from the Netherlands" (2012) 16 EdinLR 25

J Armour and S Frisby, "Rethinking Receivership" (2001) 21 OJLS 73

DA Bennett and R Roxburgh, "Heritable Property Conveyed by a Company" (1994) 39 JLSS 356

JG Birrell, "*Sharp v Thomson*: The Impact on Banking and Insolvency Law" 1997 SLT (News) 151

C Bisping, "The Classification of Floating Charges in International Private Law" 2002 JR 195

D Cabrelli, "The Case Against the Floating Charge in Scotland" (2005) 9 EdinLR 407

D Cabrelli, "The Curious Case of the 'Unreal' Floating Charge in Scotland" 2005 SLT (News) 127

I Doran, "Letter to the Editor" 1995 SLT (News) 101

I Doran, "Ownership on Delivery" 1985 SLT (News) 165

J Franks and O Sussman, "The Cycle of Corporate Distress, Rescue and Dissolution" (IFA Working Paper 306, 2000)

P Giddins, "Floating Mortgages by Individuals: Are they Conceptually Possible?" (2011) 3 JIBFL 125

R Goode, "Commercial Law and the Scottish Parliament" (1999) SLPQ 81

H Goudy, "Bankruptcy–Trust" 1891 JR 365 (Note on *Heritable Reversionary Co Ltd v McKay's Tr* (1891) 18 R 1166)

H Goudy, "Contingent Right in Bankruptcy" 1893 JR 212

GL Gretton, "Equitable Ownership in Scots Law?" (2001) 5 EdinLR 73

GL Gretton, "*Ex Facie* Absolute Dispositions and their Discharge: Exhumation" (1979) 24 JLSS 462

GL Gretton, "Insolvency Risk in Sale" 2005 JR 335

GL Gretton, "Ownership and Insolvency: *Burnett's Trustee v Grainger*" (2004) 8 EdinLR 389

GL Gretton, "Ownership and its Objects" (2007) 71 *Rabels Zeitschrift* 802

GL Gretton, "Radical Rights and Radical Wrongs: A Study in the Law of Trusts, Securities and Insolvency" 1986 JR 51 and 192

GL Gretton, "Receivers and Arresters" 1984 SLT (News) 177

GL Gretton, "Receivership and Sequestration for Rent" 1983 SLT (News) 277

GL Gretton, "Reception without Integration? Floating Charges and Mixed Systems" (2003) 78 TulaneLR 307

GL Gretton, "Scots Law in Shock: Real Rights and Equitable Interests" (1998) 6 ERPL 403

GL Gretton, "Sharp Cases Make Good Law" 1994 SLT (News) 313

GL Gretton, "Should Floating Charges and Receivership Be Abolished?" 1986 SLT (News) 325

GL Gretton, "The Floating Charge in Scotland" 1984 JBL 344

GL Gretton, "The Integrity of Property Law and of the Property Registers" 2001 SLT (News) 135

GL Gretton, "The Title of a Liquidator" (1984) 29 JLSS 357

GL Gretton, "Trusts without Equity" (2000) 49 ICLQ 599

GL Gretton, "What Went Wrong with Floating Charges?" 1984 SLT (News) 172

GL Gretton and KGC Reid, "Insolvency and Title: A Reply" (1985) 30 JLSS 109

D Guild, "*Sharp v Thomson*: A Practitioner's View" (1997) 42 JLSS 274

L Gullifer, "'Sales' on Retention of Title Terms: is the English Law Analysis Broken?" (2017) 133 LQR 245

JM Halliday, "*Ex Facie* Absolute Dispositions and their Discharge: Post-Exhumation" (1980) 25 JLSS 24

JM Halliday, "The *Ex Facie* Absolute Disposition" (1957) 1 ConvRev 5

J Hardman, "Some Legal Determinants of External Finance in Scotland: A Response to Lord Hodge" (2017) 21 EdinLR 30

WN Hohfeld, "Fundamental Legal Conceptions as Applied in Judicial Reasoning" (1916-17) 26 YaleLJ 710

WN Hohfeld, "Some Fundamental Legal Conceptions as Applied in Judicial Reasoning" (1913-14) 23 YaleLJ 16

W Lucas, "The Assignment of Floating Charges" 1996 SLT (News) 203

ADJ MacPherson, "TB Smith and Max Rheinstein: Letters from America" (2016) 20 EdinLR 42

AJ McDonald, "Bankruptcy, Liquidation and Receivership and the Race to the Register" (1985) 30 JLSS 20

AJ McDonald, "*Sharp v Thomson*: Feudal Purism – But is it Justice?" (1995) 40 JLSS 7

AJ McDonald, "*Sharp v Thomson*: What Now?" (1995) 40 JLSS 256

DW McKenzie and D O'Donnell, "Intervening Insolvency: How Can You Know?" (1996) SLPQ 173

D McKenzie Skene, “The Shock of the Old: *Burnett’s Tr v Grainger*” 2004 SLT (News) 65

R Nolan, “Property in a Fund” (2004) 120 LQR 108

H Patrick, “Charges Changing” (2013) 58(2) JLSS 20

RR Pennington, “The Genesis of the Floating Charge” (1960) 23 MLR 630

RJ Reed, “Aspects of the Law of Receivers in Scotland” 1983 SLT (News) 229

RJ Reed, “Aspects of the Law of Receivers in Scotland: II The Effect of Receivership” 1983 SLT (News) 237

RJ Reed, “Aspects of the Law of Receivers in Scotland: III The Receiver’s Duty of Care” 1983 SLT (News) 261

KGC Reid, “Equity Triumphant: *Sharp v Thomson*” (1997) 1 EdinLR 464

KGC Reid, “Jam Today: *Sharp* in the House of Lords” 1997 SLT (News) 79

KGC Reid, “Ownership on Delivery” 1982 SLT (News) 149

KGC Reid, “Ownership on Registration” 1985 SLT (News) 280

KGC Reid, “Patrimony Not Equity: The Trust in Scotland (2000) 8 ERPL 427 updated and republished in R Valsan (ed), *Trusts and Patrimonies* (2015) 110

KGC Reid, “Real Conditions in Standard Securities” 1983 SLT (News) 169 and 189

KGC Reid, “*Sharp v Thomson*: A Civilian Perspective” 1995 SLT (News) 75

R Rennie, “Dead on Delivery” 1994 SLT (News) 183

R Rennie, “Keeping the Price and the Property” 1996 JR 68

R Rennie, “*Sharp v Thomson*: The Final Act” (1997) 42 JLSS 130

R Rennie, “The Tragedy of the Floating Charge in Scots Law” (1998) SLPQ 169

R Rennie, “To *Sharp v Thomson* – an Heir” 2000 SLT (News) 247

Lord Rodger of Earlsferry, “‘Say Not the Struggle Naught Availeth’: The Costs and Benefits of Mixed Legal Systems” (2003) 78 TulaneLR 419

S Scott, "One Hundred Years of Security Cession" 2013 SA Mercantile Law Journal 513

DP Sellar, "Commercial Law Update: Rights in Security and Insolvencies" (1997) 42 JLSS 181

DP Sellar, "Commercial Law Update: Securities and Insolvency" (1995) 40 JLSS 311

DP Sellar, "Floating Charges and Fraudulent Preferences" 1983 SLT (News) 253

DP Sellar, "Future Assets and Double Attachments: *Ross v Taylor*" (1985) 30 JLSS 242

AJ Sim, "The Receiver and Effectually Executed Diligence" 1984 SLT (News) 25

TB Smith, "Property Problems in Sale: Three Footnotes" 1987 SLT (News) 241

AJM Steven, "Accessoriness and Security over Land" (2009) 13 EdinLR 388

AJM Steven, "Goodbye to Sequestration for Rent" 2006 SLT (News) 17

AJM Steven, "One Hundred Years of Gloag and Irvine" 1997 JR 314

AJM Steven and S Wortley, "The Perils of a Trusting Disposition" 1996 SLT (News) 365

S Styles, "Debtor-to-Creditor Sales and the Sale of Goods Act 1979" 1995 JR 365

SC Styles, "Sharp Pains for Scots Property Law: The Case of *Burnett's Tr v Grainger*" 2000 SLT (News) 305

SC Styles, "The Two Types of Floating Charge: The English and the Scots" (1999) SLPQ 235

K Swinton, "Is There a Need to Reverse *Sharp v Thomson*?" (2001) 69 SLG 156

NR Whitty, "*Sharp v Thomson*: Identifying the Mischief" 1995 SLT (News) 79

WAW [WA Wilson], "Effectively Executed Diligence" 1978 JR 253

WA Wilson, "Floating Charges" 1962 SLT (News) 53

WA Wilson, "The Companies (Floating Charges) (Scotland) Act 1961" 1962 JBL 65

WA Wilson, "The Nature of Receivership" 1984 SLT (News) 105

WAW [WA Wilson], "The Receiver and Book Debts" 1982 SLT (News) 129

S Wortley, “Sharp Practice for Trusting Conveyancers” (1997) 65 SLG 113

S Wortley, “Squaring the Circle: Revisiting the Receiver and ‘Effectually Executed Diligence’” 2000 JR 325

Scottish Law Commission and Related Publications

Law Reform Committee for Scotland, *Eighth Report of the Law Reform Committee for Scotland: The Constitution of Security over Moveable Property; and Floating Charges* (Cmnd 1017) (1960)

Report of the Review Committee on Insolvency Law and Practice (Cmnd 8558) (1982)

Scottish Law Commission, *Consultative Memorandum No 72: Floating Charges and Receivers* (1986)

Scottish Law Commission, *Discussion Paper on Moveable Transactions* (DP 151) (2011)

Scottish Law Commission, *Discussion Paper on Sharp v Thomson* (DP 114) (2001)

Scottish Law Commission, *Memorandum No 10 – Examination of the Companies (Floating Charges) (Scotland) Act 1961* (1969)

Scottish Law Commission, *Report on Diligence on the Dependence and Admiralty Arrestments* (No 164) (1998)

Scottish Law Commission, *Report on Registration of Rights in Security by Companies* (No 197) (2004)

Scottish Law Commission, *Report on Sharp v Thomson* (No 208) (2007)

Scottish Law Commission, *Report on the Companies (Floating Charges) (Scotland) Act 1961* (No 14) (Cmnd 4336) (1970)

Miscellaneous

Department for Business, Innovation and Skills, *Explanatory Notes to the Small Business, Enterprise and Employment Act 2015*

General Collection of Session Papers (Advocates Library): 1841-1842, vol 369; 1855, vol 493; 1903-1904, vol 839

J Hamilton, A Coulson, D Ingram and S Wortley, *Business Finance and Security over Moveable Property* (Scottish Executive Central Research Unit) (2002)

Hansard, HC (Series 5), vol 632, cols 1118-1120 (20 December 1960)

Hansard, HL (Series 5), vol 232, cols 1434-1443 (5 July 1961)

Hansard, Standing Committee Debates, Session 1960-61, vol 4, cols 3-52 (20 June 1961)

E Marshall, "Companies (Floating Charges and Receivers) (Scotland) Act 1972" in *Current Law Statutes Annotated 1972* (1972)

National Records of Scotland: AD61/36; AD61/55; AD63/481/1; AD63/481/2; AD63/481/3; HH41/1434

R3, 9th *Survey of Business Recovery in the UK* (2001)

Scottish Government, *Explanatory Notes to the Bankruptcy and Diligence etc (Scotland) Act 2007*

Scottish Law Commission Papers: L45/174/1 – Company Law, Correspondence on Memorandum No 10, Comments Received

The Times, 21 November 1972

Websites

<https://www.aib.gov.uk/about/statistics-data/aib-corporate-insolvency-statistics-2000-present>

